

The Administration of Egypt in the Old Kingdom

Nigel Strudwick

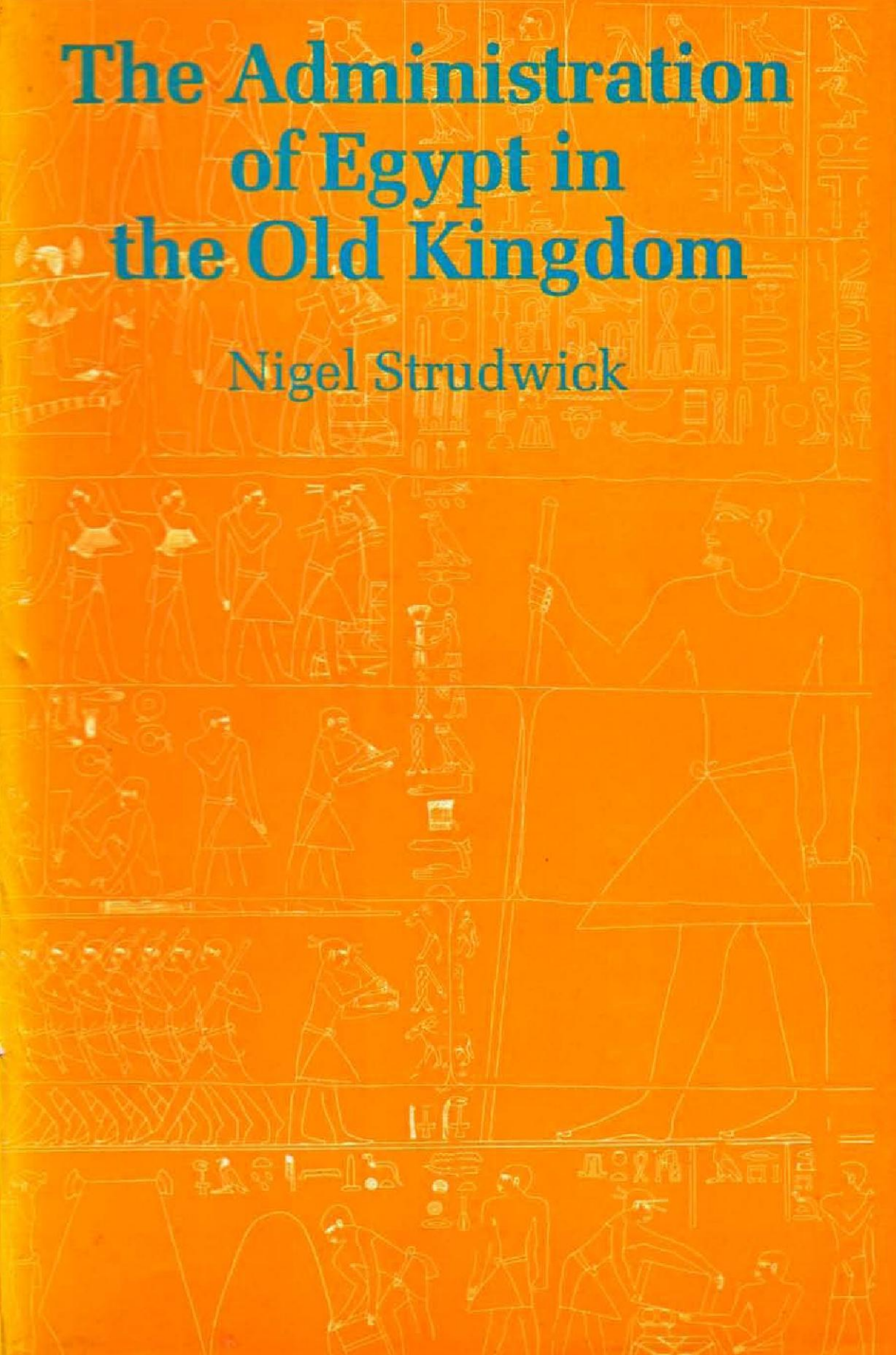

The Administration of Egypt in the Old Kingdom

Studies in Egyptology

Editor: W V Davies, Deputy Keeper
Department of Egyptian Antiquities
The British Museum

Editorial advisor: A F Shore

Already published:

The Egyptian temple; A Lexicographical study

Patricia Spencer

The Administration of Egypt in the Old Kingdom

*The Highest Titles
and their Holders*

Nigel Strudwick



KPI

London, Boston, Henley and Melbourne

First published in 1985 by KPI Limited
14 Leicester Square, London WC2H 7PH, England

Distributed by
Routledge and Kegan Paul plc
14 Leicester Square, London WC2H 7PH, England

Routledge and Kegan Paul Inc
9 Park Street, Boston, Mass. 02108, USA

Routledge and Kegan Paul
464 St Kilda Road, Melbourne,
Victoria 3004, Australia and

Routledge and Kegan Paul plc
Broadway House, Newtown Road,
Henley-on-Thames, Oxon RG9 1EN, England

Printed in Great Britain
by Unwin Brothers Ltd: The Gresham Press, Surrey

© Nigel Strudwick 1985

No part of this book may be reproduced in
any form without permission from the publisher,
except for the quotation of brief passages
in criticism

ISBN 0-7103-0107-3

Contents

List of Figures	viii
List of Tables	ix
Acknowledgements	x
Abbreviations	xii
INTRODUCTION	xiv
PART I DATING CRITERIA	1
1 CHRONOLOGY AND DATING CRITERIA	2
A. Chronology	2
B. Other Systems of Dating	4
C. Royal Names	6
D. Genealogies	7
E. When did an Official construct his Tomb?	7
2 THE FALSE DOOR AS A CRITERION FOR DATING	9
General Introduction	9
Terminology	10
I False Doors from Saqqara	12
A. The Cornice and Torus Moulding	15
B. The Number, Arrangement and Decoration of the Jambs	15
C. The Panel	18
D. The Panel Apertures	21
E. The Lintels and Architraves	22
F. Smaller Features	24
G. The Incorporation of Offering Lists into False Doors	26
H. The Relationship of False Doors and Chapel Types	29
I. Summary of Principal Conclusions	35

Contents

II False Doors and other features of Tomb Design at Giza	37
A. Introduction	
B. The Offering List in the Fourth and Fifth Dynasties	37
C. The Chapels and False Doors of the Early Period at Giza	41
D. False Door and Chapel Types at Giza which originated at Saqqara	50
E. Other Types	51
F. Conclusions	52
PART II PROSOPOGRAPHY	53
PART III SIX HIGH ADMINISTRATIVE TITLES OF THE OLD KINGDOM	171
The Selection of Titles in the Titulary of an Official	172
Terminology and Other Notes	174
3 THE OVERSEERS OF THE GREAT MANSIONS	176
General	176
The Titularies of the <i>imy-r hwt wrt</i>	178
The Viziers	186
The Functions and Organisation of the <i>hwt wrt</i>	188
A. The relationship of <i>imy-r hwt wrt</i> to <i>imy-r hwt wrt 6</i>	188
B. Other Aspects	190
Conclusions	198
4 THE OVERSEERS OF THE SCRIBES OF THE KING'S DOCUMENTS	199
General	199
The Titularies of the Non-viziers	203
The Viziers	208
The Department of the King's Document Scribes	208
A. The Organisation of <i>imy-r zš ' nzwt</i>	208
B. Other Aspects	210
Conclusions	214
5 THE OVERSEERS OF WORKS	217
General	217
The Titularies of the Non-viziers	222
A. <i>imy-r k3t nbt (nt) nzwt</i>	222
B. <i>imy-r k3t (nt) nzwt</i>	228
C. <i>imy-r k3t nbt</i>	232
D. <i>imy-r k3t</i>	235
E. Conclusions on Titularies	236
The Viziers	236
The Organisation and Functions of the Overseers of Works	237
A. The Organisation of the Overseers of Works	237
B. The Functions of the Overseer of Works	240
Conclusions	249

Contents

6	THE OVERSEERS OF THE GRANARIES	251
	General	251
	The Titularies of the Non-Viziers	256
	A. <i>imy-r šnwt</i>	256
	B. <i>imy-r šnwtj</i>	259
	C. Conclusions and Discussion of Variants	263
	The Viziers	264
	The Administration of the Granaries	264
	A. The Organisation of the Overseers of the Granaries	264
	B. Other Aspects	267
	Conclusions	275
7	THE OVERSEERS OF THE TREASURIES	276
	General	276
	The Titularies of the Non-viziers	280
	A. <i>imy-r pr-hd</i>	280
	B. <i>imy-r prwy-hd</i>	284
	C. Conclusions on Titularies and Discussion of Variants	289
	The Viziers	290
	The Administration of the Treasury	290
	A. The Overseers of the Treasuries	290
	B. Other Aspects	293
	Conclusions	299
8	THE VIZIERS	300
	General	300
	The Titularies of the Viziers	306
	A. Summary of results from Previous Chapters	306
	B. Other principal Title Groups	307
	C. A Comparison of the Titularies of Provincial Viziers	318
	D. The Career Structure of the Vizier	319
	The Organisation and Functions of the Vizierate	321
	A. The number of contemporary Viziers	321
	B. The Functions of the Vizier	328
	Conclusions	334
	PART IV CONCLUSION	336
	BIBLIOGRAPHY	347
	INDEX OF NAMES	355
	INDEX OF TITLES	362
	INDEX OF OTHER WORDS AND PHRASES	366

List of Figures

1	A False Door with names of its Principal Parts	11
2	Plans of Offering Rooms in Saqqara Chapels (1)	31
3	Plans of Offering Rooms in Saqqara Chapels (2)	32
4	Plans of Offering Rooms in Saqqara Chapels (3)	33
5	Plans of Offering Rooms in Saqqara Chapels (4)	34
6	Two Principal Chapel types at Giza in the Fourth Dynasty	42
7	West wall of the Tomb of mry-ib (G2100-I-annexe)	45
8	West wall of the Tomb of sšm-nfr I (G4940)	46
9	West wall of the Tomb of nfr-b3w-ptḥ (G6010)	47
10	Location of Viziers in the Mortuary Temple of Pepy II	65

List of Tables

1	Old Kingdom Chronology	3
2	List of Well-dated False Doors from Saqqara	13
3	Principal Component Elements of Short Offering Lists	27
4	Chapels of Private Individuals with two False Doors at Giza	43
5	Schemes of West Wall Decoration of Officials in Table 4	48
6	Principal Chapels with one False Door at Giza	49
7	List of holders of imy-r hwt wrt and imy-r hwt wrt 6	177
8	Principal Titles of non-viziers who held imy-r hwt wrt	179
9	Principal Titles of holders of hm-ntr hqt and ht h3	184
10	Certain titles of Viziers who held imy-r hwt wrt	187
11	Titles incorporating the element hwt wrt (6)	195
12	List of holders of imy-r zš ' nzw	200
13	Principal Titles of non-viziers who held imy-r zš ' nzw	204
14	List of Overseers of Works	218
15	Principal Titles of Non-viziers who held imy-r k3t nbt (nt) nzw	223
16	Principal Titles of holders of imy-r k3t nzw	229
17	Principal Titles of non-viziers who held imy-r k3t nbt	233
18	Principal Titles of holders of imy-r k3t	234
19	Distribution of Overseers of Works by date	237
20	List of Overseers of the Granaries	252
21	Principal Titles of holders of imy-r šnwt	257
22	Principal Titles of non-viziers who held imy-r šnwt	260
23	List of Granary Titles in the titularies of Tomb Owners	273
24	List of Overseers of the Treasuries	277
25	Principal Titles of holders of imy-r pr-hd	281
26	Principal Titles of non-viziers who held imy-r prwy-hd	285
27	Treasury Titles held by Tomb Owners	297
28	List of Viziers	301
29	Principal Titles of Memphite Viziers	308
30	Frequency of the more important Honorific Titles	310
31	Principal Titles of Provincial Viziers	319
32	Distribution of Old Kingdom Viziers by date	323

Acknowledgements

This book is a modified and corrected version of a thesis presented to the University of Liverpool for the degree of Doctor in Philosophy in June 1983 under the title 'Aspects of the Administration of the Memphite Region of Egypt in the Old Kingdom'. My research was supervised by Professor A.F. Shore, and examined by Professor H.W. Helck in November 1983.

I wish to express my gratitude to Professor Shore for his efforts on my behalf while a postgraduate student at Liverpool. Without his guiding hand and depth of knowledge, many pitfalls and errors could not have been avoided. To Professor Helck I am indebted for many valuable comments made during my examination, most of which I have tried to incorporate into this book. My thanks are also due to Dr. C.J. Eyre for reading through the text of the thesis and making many suggestions for improvements.

I should like to thank Professor W.K. Simpson and Dr. E.J. Brovarski for their kindness in making the Reisner material in the Museum of Fine Arts, Boston available to me during a study visit, and permitting me to refer to much of it in this book. I am also very grateful to Dr. Mohamed Saleh, Dr. J-L. de Cenival, Mme C. Ziegler, Dr. C. Lilyquist, and Dr. S. Schoske for information about pieces in their charge. My study of monuments in Egypt has been greatly assisted by many members of the Egyptian Antiquities Organisation, in particular Dr. Ahmed Moussa and Mr. Said el-Fikey. I owe a great debt to the Egypt Exploration Society, which, by giving me the opportunity to take part in its fieldwork, has allowed me to examine much material in its original setting; it has also permitted me to mention unpublished material from the tomb of **nfr-sšm-ptḥ** at Saqqara and to reproduce illustrations from James, **The Mastaba of Khentika called Ikhekhi**. Credit must also be paid to the Griffith Institute, Oxford for allowing me to refer to unpublished manuscripts in its care, and to use plans from the **Topographical Bibliography**.

The use of computers in the research for this book would have been impossible without an immense amount of help from the Computer Laboratory of the University of Liverpool. To all members of staff there I extend my grateful thanks.

Acknowledgements

My thanks are due to Mr. W.V. Davies for his recommendation of this book to Routledge and Kegan Paul International, and to Mr. P. Hopkins, director of that company, for undertaking to publish it. I wish to thank the Governing Body of Worcester College, Oxford for a grant from the Laycock Fund towards the cost of production of this manuscript.

My greatest single debt is to my wife, who has been a great strength to me in the different stages of the production of this book. She has also read it through on several occasions, saving me from countless errors of all descriptions; without her, this book could not have appeared in its present form.

Lastly, I must express my gratitude to my parents. They have always done their utmost to help me pursue my interest in Egyptology, and have encouraged me immeasurably while researching the present work. I would like to dedicate this book to them.

Abbreviations

The majority of abbreviations used in this work follow those employed in Helck and Otto (ed.), **Lexikon der Ägyptologie**. Only those which do not appear therein are given below.

- Acts 1st ICE** - **Acts of the First International Congress of Egyptology**, Cairo October 2-10, 1976, Berlin 1979
- de Cenival, Chefs de travaux** - de Cenival, J.-L., "Les chefs de travaux dans l'ancienne Egypte (1)", *Ecole pratique des hautes études IVe section, sciences, historiques et philologiques Annuaire* 1962/63, 225-31
- CG 57001-50** - Moret, A. and Abu-Ghazi, Dia', **Catalogue Général des Antiquités Egyptiennes du Musée du Caire: Denkmäler des Alten Reiches III**, fasc. 1-2, Le Caire 1978-80.
- Fischer, Dendera** - Fischer, H.G., **Dendera in the Third Millennium B.C. down to the Theban Domination of Upper Egypt**, Locust Valley 1968.
- Fischer, Offerings** - Fischer, H.G., "Offerings for an Old Kingdom Granary Official", **Bulletin of the Detroit Institute of Arts** 51 (1972), 69-80.
- Fischer, Varia** - Fischer, H.G., **Egyptian Studies I: Varia**, New York 1976.
- Fs Berlin** - **Festschrift zum 150jährigen Bestehen des Berliner Ägyptischen Museums**, Mitteilungen aus der Ägyptischen Sammlung VIII, Berlin 1974.
- Fs Edel** - **Festschrift Elmar Edel**, Studien zu Geschichte, Kultur und Religion Ägyptens und das Alte Testaments I, Bamberg 1979.
- Fs Otto** - **Fragen an die altägyptische Literatur**. Studien zum Gedenken an Eberhard Otto, Wiesbaden 1977.
- Giza Mastabas** - Giza Mastabas, edited by W.K. Simpson. Based on the excavation and recording of the Late George Andrew Reisner and William Stevenson Smith, Museum of Fine Arts-Harvard University Expedition, Boston 1974 ff.
- HAB** - **Hildesheimer Ägyptologische Beiträge**, Hildesheim 1976 ff.
- Hassan, Saqqara** - Hassan, Selim, **Excavations at Saqqara 1937-8**, 3 vols., Cairo 1975.
- HPBM** - Posener-Kriéger, P., and de Cenival, J.-L., **Hieratic Papyri in the British Museum; Fifth Series, The Abusir Papyri**, London 1968.
- James, Khentika** - James, T.G.H., **The Mastaba of Khentika called Ikhekhi**, (with M.R. Apted), ASE 30, London 1953.
- Kanawati, Egyptian Administration** - Kanawati, N., **The Egyptian Administration in the Old Kingdom: Evidence on its Economic Decline**, Warminster 1977.
- Kanawati, Governmental Reforms** - Kanawati, N., **Governmental Reforms in Old Kingdom Egypt**, Warminster 1980.
- Kanawati, Hawawish** - Kanawati, N., **The Rock Tombs of el-Hawawish, the Cemetery of Akhmim**, Sydney 1980 ff.

Abbreviations

- Kees, **Provinzialverwaltung** - Kees, H., "Beiträge zur altägyptischen Provinzialverwaltung und der Geschichte des Feudalismus": I, Oberägypten, NAWG 1932, 85-119, II, Unterägypten, NAWG 1933, 579-98.
- Kees, **Veziat** - Kees, H., "Beiträge zur Geschichte des Veziats im Alten Reich", NGWG N.F. 4 nr. 2 (1940), 39-54.
- L'égyptologie en 1979** - **L'égyptologie en 1979**. Axes prioritaires de recherches, 2 vols, Colloques Internationaux de C.N.R.S. no. 595, Paris 1982.
- Martin, **Hetepka** - Martin, G.T., **The Tomb of Hetepka and other Reliefs and Inscriptions from the Sacred Animal Necropolis, North Saqqara 1964-73**, Texts from Excavations 4, London 1979.
- Martin-Pardey, **Provinzialverwaltung** - Martin-Pardey, E., **Untersuchungen zur Ägyptischen Provinzialverwaltung bis zum Ende des Alten Reiches**, HAB 1, Hildesheim 1976.
- Mostafa, **Opfertafel** - Mostafa, Maha M.F., **Untersuchungen zu Opfertafeln im Alten Reich**, HAB 17, Hildesheim 1982.
- Moussa-Altenmüller, **Nianchnum** - Moussa, A.M., and Altenmüller, H., **Das Grab des Nianchnum und Chnumhotep**, Old Kingdom Tombs at the Causeway of King Unas at Saqqara, Deutsches Archäologische Institut. Abteilung Kairo, Archäologische Veröffentlichungen 21, Mainz 1977.
- Posener-Kriéger, **ArchAb** - Posener-Kriéger, P., **Les archives du Temple funéraire de Neferirkare-Kakai (Les papyrus d'Abousir)**, Traduction et Commentaire, 2 vols., BdE 65, Le Caire 1976.
- Reisner, **Mycerinus** - Reisner, G.A., **Mycerinus, The Temples of the Third Pyramid at Giza**, Cambridge 1931.
- Schmitz, **Königssohn** - Schmitz, B., **Untersuchungen zum Titel s3-njswt "Königssohn"**, Habelts Dissertationsdrücke, Reihe Ägyptologie, Heft 2, Bonn 1976.
- Simpson, **Sekhem-anh-ptah** - Simpson, W.K., **The Offering Chapel of Sekhem-anh-ptah in the Museum of Fine Arts, Boston**, Boston 1976.
- Weil, **Veziere** - Weil, A., **Die Veziere des Pharaonenreiches**, Strassburg 1908.
- Wiebach, **Scheintür** - Wiebach, S., **Die Ägyptische Scheintür: Morphologische Studien zur Entwicklung und Bedeutung der Hauptkultstelle in den Privat-Gräbern des alten Reiches**, Hamburger Ägyptologische Studien 1, Hamburg 1981.

Introduction

The purpose of this book is to study a group of the highest civil administrative titles of the Old Kingdom from the standpoint of the memphite region. Previous studies of the administration of this period have tended to concentrate on the nature and functions of the lower-ranking officials rather than the higher; there are no works devoted principally to such offices as that of the Vizier or Overseer of Works in the Old Kingdom. The desire to fill this gap has resulted in the present work.

The term 'memphite' is used to refer to the central administration of the period based in the capital city of Memphis; this is to be contrasted with the provincial administration which developed in the course of the Old Kingdom. The officials whose monuments provide the bulk of the material used in this study were all buried in what may be termed the cemeteries of Memphis, comprising principally the sites of Giza and Saqqara, and to a lesser extent Meydum, Dahshur and Abu Roash.

The selected titles encompass five important areas of the administration of the Old Kingdom: the legal system, the scribal bureaucracy, the organisation of labour and of the granaries and treasuries. To these must be added the supreme office in the land, that of the Vizier. One chapter is devoted to each of these areas, with similar methods used so as to examine the titles from similar standpoints.

Dating is clearly of central importance to a study confined as this is to one particular period, particularly because of the need to monitor changes over relatively short periods of time. Part I of this work was originally intended to summarise the dating criteria to be used in the prosopographical section; it has since been augmented by an examination of the potential of the false door for the purposes of dating, and many criteria thus obtained have not been analysed or consistently applied before.

The Prosopography aims to give the provenance, bibliography and titles of all Old Kingdom officials who bear one or more of the titles forming the principal subject of this work, and to discuss their dates. Although such a collection of material can never be truly exhaustive, every effort has been made to secure reasonably

Introduction

complete data for all these officials; in particular, the records of the Harvard-Boston excavations at Giza have been examined, as well as the actual monuments themselves still standing in Egypt and in museum collections.

Much of the data analysis for this work has been carried out with the aid of computers. A summary of the methods used will be found in the author's paper 'An Application of Information Retrieval and Analysis in Egyptology' in **Proceedings of the 1982 Computer Applications in Archaeology Conference** (Birmingham 1982). The present version of this book has been produced using an Apple IIe computer and a Juki 6100 printer.

The methods of production have suggested that some of the conventions normally used in works of this type be modified. For typographical simplicity, the transliterations *i* and *'* replace *ī* and *ĳ*. Words which would ideally appear in italics have been emphasised by the use of **bolding**.

Unless indicated otherwise, numbers in brackets following names of officials refer to the reference numbers to be assigned to them in the Prosopography (Part II).

PART I

Dating Criteria

1 Chronology and Dating Criteria

The general use of dates such as 'fourth dynasty', 'fifth dynasty' and so on is frequent and perhaps permissible when the scope of the work in question is a large part of Egyptian History. In a study devoted to the Old Kingdom alone, an attempt must be made to pinpoint the dates of individual officials and monuments. On occasions when this has been carried out, the results have been encouraging.¹

There are a number of criteria to which one may refer for help in the dating of Old Kingdom officials and their monuments. Many of these have been summarised by Baer, and his account is recommended as a general exposition of this subject.² Some additional comment may be offered on his criteria, and some further ones discussed.

A. Chronology

For the length and order of the reigns of kings, the figures in the Turin Canon are generally accepted without comment, as this document forms the basis of the overall chronological structure of Egyptian History before the New Kingdom.³ The chronology adopted in this work may be found in table 1.

The standpoint adopted here as to the usefulness of cattle-counts found on contemporary monuments is that the period between them was sometimes one year, sometimes two and sometimes perhaps even longer. As far as the Egyptians were concerned, the dates of these countings of the cattle were well known, and the fact that they were not always conducted at regular intervals was not

-
- 1 For example, the dating of the 'princes' at Dahshur by Schmitz (*Königssohn*, 141-58) and that of *r'-wr* at Saqqara by el-Fikey (*The Tomb of the Vizier Re'-wer at Saqqara*, 44-6).
 - 2 *Rank and Title*, 44-51.
 - 3 Gardiner, *The Royal Canon of Turin*, *passim*.

Chapter 1 - Chronology and Dating Criteria

Table 1
Old Kingdom Chronology

King	Years in Reign	Dates B.C.	
Zanakht	?	? -2594	
Netjerychet	19	2593-2575	
Sekhemchet	6	2574-2569	
Khaba	6	2568-2563	
Huni	24	2562-2539	
Sneferu	24	2538-2515	
Khufu	23	2514-2492	
Djedefre	8	2491-2484	
Khafre	23	2483-2461	
?Nebka/Wehemka?	1	2460	
Menkaure	18	2459-2442	
Shepseskaf	4	2441-2438	
? ? ?	2	2437-2436	
Weserkaf	7	2435-2429	
Sahure	12	2428-2417	
Neferirkare Kakai	10	2416-2407	?
Shepseskare Izi	7	2406-2400	
Neferefre	1	2399	
Neweserre Ini	11	2498-2388	?
Menkauhor Ikauhor	8	2387-2380	
Djedkare Izezi	28	2379-2352	
Wenis	30	2351-2322	
Teti	12	2321-2310	?
Neferzahor/Meryre Pepy I	46	2309-2264	?
Merenre Nemtyemzaf I	7	2263-2257	
Neferkare Pepy II	90	2256-2167	
Merenre Nemtyemzaf II	1	2166	?
Dynasties Seven to Eight	25 (total)	2165-2141	
Beginning of Dynasty Nine		2140	

All reign lengths and dates are approximate

important. As such, their usefulness for precise dating is somewhat limited.¹

The reading of eleven years for the reign of Neweserre in the Turin Canon follows that of Gardiner in his publication of that papyrus. A figure of perhaps ten years is given for the reign of Neferirkare on the basis of the unfinished state of his pyramid complex. The short reigns given in the Turin Canon for the minor

1 The Egyptian term translated 'cattle-count' is here read as **rnpt zp**, irrespective of what it may have been at later periods (see Edell, JNES 8 (1949), 35-9).

fourth dynasty kings are included, although the existence of a reign between those of Shepseskaf and Weserkaf cannot be proven from the monuments.

The other contentious point is the length of the reigns of Teti and Pepy I. The total for both, arrived at by deducting the better-known reign lengths and the total for dynasties seven and eight from the Turin Canon figure of 181 years for dynasties six to eight, is perhaps about sixty years. In the Canon, the year figure for Teti is destroyed, while that of Pepy I is given as twenty. The highest cattle-counts known for each king are respectively **rnpt (m-)ht zp 6** and **rnpt m-ht zp 25**.¹ The latter is the only known example of a king having more cattle-counts than years in the Turin Canon, and thus there may be an error in the papyrus. Alternatively, the apparent gap between the entries for the two kings in the Canon may have furnished an explanation for this discrepancy. At the risk of interpreting the cattle-counts too rigidly, these figures may perhaps indicate reigns of about twelve years for Teti and up to fifty for Pepy I.

The same is true for **sd** festivals, known for the reigns of Netjerychet, Neweserre, Djedkare, Pepy I and Pepy II. The thirty year period often found in later times cannot be attested until the late Old Kingdom at the earliest, and so their use is also limited.²

B. Other Systems of Dating

There have been but two serious attempts to establish systematic criteria for dating monuments of the Old Kingdom. Baer (**Rank and Title in the Old Kingdom**) has attempted to show that a relatively standardised system of ranking (or ordering) of titles on a monument was established in the early fifth dynasty and continued to the end of the Old Kingdom. Within that period, the system was changed from time to time, and because of these changes, reflected in the order of the titles in (usually) funerary inscriptions, the titularies of many officials show characteristics of various periods, and many of those who antedate or postdate this system will not fit any of these periods. To establish the basic ranking charts for the Old Kingdom, a number of reasonably well-dated officials were chosen, each of a slightly different date and whose title sequences were not similar. This set of sequences was used as a basis for the period in which they lived. To these were added further similar examples which enabled these periods to be defined more closely.³ Apart from the problems of this system outlined by Baer,⁴ there are objections of a methodological nature. The

1 Respectively, Anthes, **Die Felsinschriften von Hatnub**, Taf. 9 (Gr. 1); **Urk. I**, 95.16.

2 cf. Hornung-Staehelin, **Studien zum Sedfest**, 62-5, 82.

3 Baer, **op. cit.**, 221-40.

4 **op. cit.**, 10-12.

first concerns his base charts for the different periods.¹ Particular criticism can be made of the choice of *k3i* and *m3-nfr* for this purpose. Little of the evidence Baer gives concerning *k3i* is conclusive enough for him to be allotted a reasonably certain date,² and the choice of *m3-nfr* for his period VIF appears to be almost arbitrary.³

Baer has perhaps also attempted to be too precise in the spans of time he gives to each period. It is logical to expect that there would be a certain amount of overlap between the various periods as the new sequences took effect, but it is a little dangerous to propose actual year limits, even though they are only estimates. This is particularly true for the long and (as far as dates are concerned) relatively poorly-documented reign of Pepy II. The dates of change in these periods can only be very approximate.⁴

Another difficulty is that of the extent of agreement between the charts of individual officials and the base ones. One may sometimes question the assignation of tombs to certain periods, as the ranking charts of some officials belong no more to the period suggested by Baer than to another.⁵

A more general problem can be best expressed in the words of a reviewer:

At any period in history the officials of a society are surely so conscious of their ranks and titles that no fixed list is required for their classification.⁶

We are never likely to know whether this is true for the Egyptians of the Old Kingdom, although given the importance and power of titles to those people it is always possible that such a system did exist, although perhaps not quite as formalised as Baer would have us believe.

The work of Kanawati (*The Egyptian Administration in the Old Kingdom*) is based on the premise that people of a similar class at a similar time would have had tombs of broadly similar area. If tomb area is directly related to wealth, which would vary at different periods in the Old Kingdom, such a thesis must then assume that everyone would put exactly the same proportion of their wealth into their tomb, and does not take into account the possibility that preparation for death might well have been more important to one man than to another, rather as size of house nowadays does not

1 *op. cit.*, 224.

2 *op. cit.*, 138-9 (505).

3 *op. cit.*, 77 (171), where the date is initially given as VI?.

4 This problem is illustrated by the doubt placed on the time of the change from period VB to VC (in the reign of Djedkare) as a result of recent work on the tomb of *sndm-ib; inti* (see the Prosopography (120) for more detail).

5 In this context one may quote the examples discussed in the Prosopography below of *ihy* (15) and *'nhj-m-'-k3i* (31).

6 James, *JAOS* 83 (1963), 120.

automatically reflect the owner's income and wealth.

As his basic criterion is tomb area, only those officials whose tombs are adequately preserved could be included. A large number of men are thereby removed from consideration. Officials are divided into four categories: viziers and high, middle and low officials. By assigning dates to a number of officials in each class, a graph may be drawn showing the fluctuation of tomb size in the Old Kingdom. Further officials may be dated by attempting to fit their tomb areas onto the relevant graph.

Unlike Baer, Kanawati discusses individually the date of only a few of his officials,¹ and in consequence it is not always possible to verify some of the arguments he uses. A more serious criticism is that nowhere does he explain how the groups of titles which are given as characteristic of each of his classes of official have been obtained. It would also seem that there are a large number of men of the same class but with different tomb sizes from the same reign, for example the higher officials of that of Djedkare.² Consequently it may well be asked whether there really is any consistent pattern apparent, if supposedly similar officials of the same date had widely differing tomb sizes, although it would be conceded that in general there must have been some correlation between wealth and lavishness of tomb.

The study of the change in size of private tombs in the Old Kingdom should not be too closely associated with the dating of these tombs. A system of ranking titles is likely to have been a feature of many official transactions and also an accepted part of an official's titulary, although personal whim may have had some effect on the order in which the titles were inscribed in a tomb chapel, for example in repeating titles of which the owner was especially proud.

C. Royal Names

An occurrence of the name of a king alone or as part of a title or building name should only be taken as a **terminus ante quem non** for dating purposes. This matter is discussed by Baer and Junker,³ and there is indeed little that can be added to this, particularly with regard to temple titles. The expression **im3hw hr** (king) is considered to show that the man in question was actually contemporary with the named ruler. There is some evidence that this might not always be the case, most frequently in connection with Wenis.⁴ It is perhaps possible that such a feature was confined to certain cults (perhaps indeed only that of Wenis) which lasted well beyond the Old Kingdom. This is preferable to using these examples to cast doubt on all other occurrences of this phrase.

1 **Egyptian Administration**, 10-34.

2 **op. cit.**, 19-21.

3 **Rank and Title**, 45-7; **Giza XII**, 19-23.

4 For one example see Baer, **op. cit.**, 44-5; for others, see Altenmüller, **SAK 1** (1974), 1-18.

D. Genealogies

The information available for establishing relationships in the Old Kingdom is rather sparse, and it may be contrasted with that available for the Middle and New Kingdoms, where representations and enumerations of whole families are not uncommon. Because of the commonness of many Old Kingdom private names, it is a dangerous matter to attempt to link individuals from different tombs. Most of the genealogies noted in the following pages have been established before, and new ones are only proposed when there is a good degree of similarity of site, titles, style, tomb design and, of course, names.¹

The separation in date of two generations of the same family is an unknown quantity. The figure of twenty to twenty-five years is here adopted very tentatively as an average figure, although in many cases this will be far too short.²

With regard to royal genealogies, the view of Junker is followed, that, in the fourth and fifth dynasties, only the presence of titles with the epithet *n itj.f* in the titulary of an official is indicative of true royal filiation.³

In addition, some assumptions need to be made with reference to the point in the lifetime of a king, particularly those of the fourth dynasty, at which his children by different wives may have been born. Nothing is known about the privileges and status of the crown prince or heir designate; he would presumably have been married, but did he practise polygamy, as he certainly would once he became king? There is no evidence for any of the princes of the fourth dynasty having been polygamous, and we will assume that this applied also to the crown prince. His wife at that time was likely, although again an assumption, to be the woman who was later his chief queen. By inference from these premises, king's sons not of the principal queen are only likely to have been born during the reign of the ruler in question, which gives us a very useful point of departure for the dating of some officials of the fourth dynasty.

E. When did an Official construct his Tomb?

We cannot say at what age a man may have built his tomb, but there is some evidence as to the point in his career at which this happened. It is important to stress that we use the term "build" very loosely, in fact more often meaning the time when the decoration was applied, since, as clearly happened at Giza, there need be no relation between the dates of construction and decoration. Texts in the tomb of *sdm-ib; inti* at Giza show that the tomb

- 1 One such example is the probable relationship between *k3i-m-tntt* (146) and *'nh-izzi* (26).
- 2 This follows Bierbrier, *The Late New Kingdom in Egypt*, xvi.
- 3 *Giza II*, 31-4. His discussion is now supplemented by that of Schmitz (*Königsson*, 58-64).

Chapter 1 - Chronology and Dating Criteria

was probably not even under construction at his death since it took his son fifteen months to complete it.¹ Other texts in the tomb show **sdm-ib** addressed as vizier by Djedkare, and thus he had clearly reached the peak of his career without building a tomb. Other tombs show that the owner was promoted after all or part of the decoration of the tomb had been completed (for example, see **h'f-hwfw** I and **sšm-nfr** III in the Prosopography below), but as the majority were decorated in one phase only, we conclude that an official probably waited a long time before building his tomb, perhaps until he felt he had reached the likely peak of his career; at what point in his life this was remains unclear, although one cannot imagine that it was particularly early.

1 Urk. I, 65.5

2 The False Door as a Criterion for Dating

General Introduction

For many of the officials studied here, the dates arrived at by the use of standard criteria summarised in chapter 1 do not provide a close period of time to which they may be assigned. The frequent survival of the false door of many officials suggests the use of this object as a possible criterion for dating by establishing dates for the appearance and development of certain well-defined physical features based on securely dated examples. The principal among these are the cornice and torus moulding, the jambs, the panel, the lintels and architraves, and several lesser features as well as the use of offering lists. Associated topics are the position of the false door in relation to the rest of the tomb, and the types of tomb-chapel in which particular classes of false door appear.

Previous work on false doors has generally concentrated on broad details of their development. The principal study in this context is by Rusch,¹ the major drawback of which is the use of many dates which are very vague and are now no longer regarded as valid. Other accounts are by Reisner, Badawy, and Hassan.² The account of Badawy is much concerned with the function and general development of the door, and in this context one may add studies by Müller, Junker, and Fischer,³ particularly with reference to its relationship to the stela.

The very recent work on the Old Kingdom false door by Wiebach (*Die altägyptische Scheintür*) is again principally devoted to the overall development, functions and locations of the door, as well

- 1 ZAS 58 (1923), 101-24, used as the basis of the categorisation in Vandier, *Manuel II* i, 389-431.
- 2 Respectively, Giza I, 330-46, 372-9; ASAE 48 (1948), 213-43; Giza V, 65-180.
- 3 Respectively, MDAIK 4 (1933), 165-206; Giza II, 4-19; Dendera, 57-65.

as the status of its owners. The section on dating is brief (pages 17-21), and consists of a critique of Rusch's system, with the conclusion that this produces useful criteria on only a few points. Wiebach makes no attempt to date carefully many specific features of false doors, but is again content to describe them in general terms.

False doors will here be discussed in two groups, those coming from the necropolis of Saqqara and those from Giza. Examples from Dahshur seem to be closely related to those from Saqqara and will consequently be considered as part of that group. Such a division is employed because of the recognised differences between examples from both groups.¹ To quote but two such differences: in the fourth dynasty, very different chapel types are evident at the two sites;² secondly, the false door with torus moulding and cornice appears at Saqqara in the early fifth dynasty,³ but is found only occasionally at Giza before the beginning of the sixth dynasty.⁴

Terminology

Figure 1 presents the terms as used here to describe the principal elements of a false door. Three particular points require further explanation: 'CORNICHE' indicates the cavetto cornice to be found above the architraves of doors, although a second is occasionally found within the outer one. 'TORUS' or 'TORUS MOULDING' indicates the roll around the outer edges of the door intended to represent original fibrous binding. It is always found in conjunction with a cornice. The terms 'ONE-JAMB DOOR', 'TWO-JAMB DOOR' and 'THREE-JAMB DOOR' describe a false door with respectively one, two or three pairs of jambs.

- 1 Wiebach, *op. cit.*, 19, with references.
- 2 Compare the plans of the chapels of *mtn* (LD, Text I, 142 (6)) and *h'f-hwfw* I (Simpson, *Giza Mastabas* III, fig. 19).
- 3 That of *pr-sn*, reign of Sahure (Petrie-Murray, *Memphite Tomb Chapels*, pl. IX).
- 4 The earliest well-dated example is that of *sndm-ib; inti* (Mariette, *Mastabas*, 505-7).

Figure 1: A False Door with names of its Principal Parts

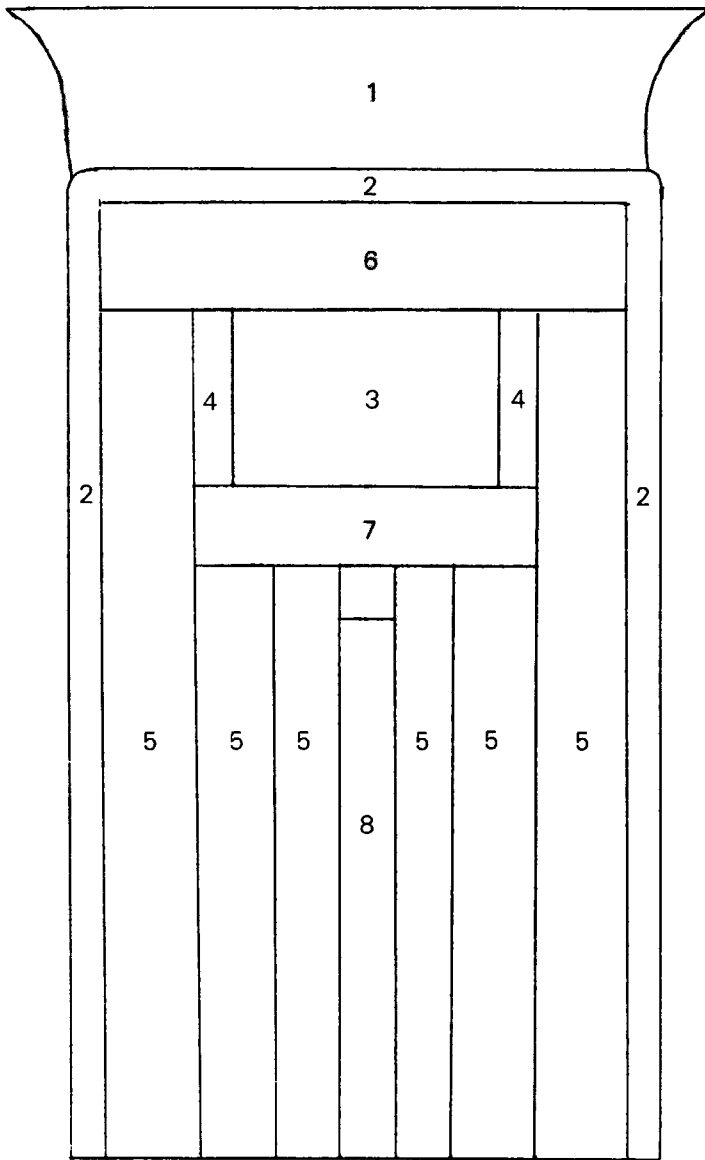

Key to Parts:

- | | | | |
|---|---------|---|---------------|
| 1 | Cornice | 2 | Torus |
| 3 | Panel | 4 | Apertures |
| 5 | Jamb | 6 | Architrave |
| 7 | Lintel | 8 | Central Niche |

Section I: False Doors from Saqqara

The study of false doors from this site will be built around a base list of examples (Table 2) which may be dated using criteria other than those derived from features of false doors. Most of these officials will be discussed below in the Prosopography; some, however, do not bear titles to be discussed in this study and consequently will not appear there. These are **mtn**, **šry**, **pr-sn** [ⓐ], **ny-'nh-šhmt** [ⓐ], **pth-špss** [ⓐ] (fifth dynasty), **hnmw-htp**, **nfr**, **k3h3i**, **nfr-sšm-ptḥ**, **shntyw**, **irw-k3-ptḥ**, **hmt-r'**, and **pth-špss** [ⓐ] (sixth dynasty). For those marked [ⓐ], the dates of Baer may be consulted.¹ Of the others, general stylistic features cause **mtn** and **šry** to be dated to the fourth dynasty, while **hnmw-htp**, **nfr**, **k3h3i**, **nfr-sšm-ptḥ**, **shntyw** and **irw-k3-ptḥ** were buried in the area of Saqqara that was later to be occupied by the causeway of the pyramid of Wenis. Although the causeway did not pass over the tombs of **nfr** and **k3h3i**, it is perhaps likely that no more tombs were built in the immediate area following this construction.² They all may thus be dated to the period mid-fifth dynasty to the reign of Wenis. An approximate date for **hmt-r'** is suggested by the presence of cartouches of Wenis and Teti in her tomb. In discussion of specific points, the doors in this list will be augmented with less well-dated examples that illustrate the features in question. At the end of each subsection, a list will be given of the officials in the Prosopography whose dating has been assisted by the use of this particular feature.

1 All references to Rank and Title: **pr-sn** 72 (144), **ny-'nh-šhmt** 86 (221), **pth-špss** (fifth dynasty) 75-6 (164), **pth-špss** (sixth dynasty) 76-7 (168).

2 Moussa-Altenmüller, Nianchchum, 44-5.

Table 2

List of Well-dated False Doors from Saqqara

Date/Owner	Published Source
Early 4	
<u>mtn</u>	LD II, 3.
Mid-late 4	
<u>mry</u>	Assemblage of parts, Fischer, <i>Varia</i> , 28, fig. 1.
<u>šry</u>	Lower part, Cairo, CG 1384; Upper part, Lepsius, <i>Auswahl</i> , Taf. IX (upper)
Sahure	
<u>pr-sn *</u>	Petrie-Murray, <i>Memphite Tomb Chapels</i> , pl. IX.
<u>ny-'nh-šhmt</u>	Cairo, CG 1482.
Neferirkare	
<u>wšš-ptḥ</u>	Mariette, <i>Mastabas</i> , 268-71; Mogensen, <i>Inscriptions Hieroglyphiques du Musée National de Copenhague</i> , pl. X-XI.
Neweserre	
<u>pth-špss</u>	BM <i>Stelae I</i> ² , pl. XVII.
Mid 5 - Menkauhor	
<u>ph-n-wi-k3i *</u>	LD II, 48.
<u>ntr-wsr</u>	Murray, <i>Saqqara Mastabas I</i> , pl. XX.
<u>hnmw-htp</u>	Moussa-Altenmüller, <i>Nianchchnum</i> , Abb. 26.
<u>nfr and k3ḥ3i</u>	id., <i>The Tomb of Nefer and Ka-hay</i> , pl. 28-9, 32, 36, 39.
Djedkare	
<u>pth-htp I *</u>	Murray, <i>op. cit.</i> , pl. VIII;
<u>nfr-sšm-ptḥ *)</u>	Moussa-Junge, <i>Two Tombs</i>
<u>šhnty *)</u>	of Craftsmen, illustr. 1-3.
<u>irw-k3-ptḥ *)</u>	

Table 2 continued

Wenis

'nh-izzi * Mariette, **Mastabas**, 191.
 3ht-htp * Davies, **Ptahhetep and Akhethetep II**, pl. XXVIII-IX.

Late 5

pth-htp II * Paget-Pirie, **Ptah-hetep**, pl. XXXIX.

Early 6 - Teti

k3i-gmni * von Bissing, **Die Mastaba des Gem-ni-kai II**, Taf. XXXIV.
 nfr-s3m-r' * Capart, **Une Rue de Tombeaux à Saqqarah**, pl. XI.
 s3bw; ibbi * Cairo, CG 1565; Mariette, **Mastabas**, 412-5.
 nfr-s3m-ptḥ * Capart, *op. cit.*, pl. XCIV.
 hmt-r' * Hassan, **Saqqara III**, fig. 2, pl. II.
 mrrw-k3i * Duell, **Mereruka I**, pl. 62

Early Pepy I

nfr-s3m-ptḥ * Unpublished (Door in later rooms).
 hnty-k3i * James, **Khentika**, pl. XIX, XIII.
 mhḥw * Saad, **ASAE 40 (1940)**, pl. LXXXI.

Mid - late Pepy I

pth-špss * Murray, *op. cit.*, pl. XXVIII.
 r'-wr * el-Fikey, **The Tomb of the Vizier Re'-wer at Saqqara**, pl. 5, 9, 21.
 mry-tti * Unpublished (son of mrrw-k3i).
 zzi * Mariette, **Mastabas**, 420.

Merenre - early Pepy II

mrrri * Hassan, **Saqqara III**, fig. 17b.
 'nh-mry-r' * Unpublished (son of mhḥw).

Mid Pepy II

hnmw-htp * Jéquier, **Pepi II III**, fig. 63.

Later Pepy II

ny-hb-sd-nfr-k3-r' * *id.*, *ib.*, fig. 60.
 tti * *id.*, *ib.*, fig. 70.

* indicates false door with cornice and torus moulding.

A. The Cornice and Torus Moulding

The presence or absence of these features is perhaps the most obvious difference between many false doors. Rusch used it as the basis of his system of differentiation, as did Wiebach.¹

Wiebach has noted that the cornice and torus appear first in the early to middle fifth dynasty in both royal and private contexts.² In her list appear several examples, the dating of which cannot yet be closely ascertained (ty, for example). The earliest example in table 2 with a cornice and/or torus is that of **pr-sn** (omitted by Wiebach) of the reign of Sahure or slightly later. From the time of **ph-n-wi-k3i** onwards almost all the well-dated examples exhibit a torus and cornice, the only exceptions being those of **hnmw-htp**, **nfr** and **k3h3i**. These men are of much lower rank than most of the others, and it would thus seem that this newer type of false door was at first reserved only for the most important officials (its appearance with **nfr-s3m-ptḥ**, **shntyw** and **irw-k3-ptḥ** from the same group of tombs probably indicates that they were the latest tombs in this group). The owner of the earliest example (**pr-sn**) must thus have been particularly favoured to have had such a door at this early date.

In the sixth dynasty, the addition of a torus and cornice may be considered as the norm. Before this date it was very much an indication of the importance or favoured status of an individual.³

This feature has been of assistance in deciding dates for:

'nh-m-'-k3i (31) **k3i** (136) **k3i-m-snw** (144)

B. The Number, Arrangement and Decoration of the Jambs

The earliest examples in table 2 are most closely related to the deep niche as found in the third dynasty:⁴ in the niche of **mtn**, there is a large difference in depth between the panel and the figures on the walls of the chapel. It is likely that this original arrangement of the niche and walls either side of it gradually developed into the false door with two pairs of jambs. In the example of **mtn**, the figures on the outer level of the niche face away from the centre, but the slightly later examples of **mry** and **šry** show them facing towards it. The outer figures of **mtn** and **mry** are larger than the inner ones. In all cases the figures are surmounted by columns of inscription. Thus the two-jamb door had

1 Respectively, ZAS 58 (1923), 106 ff, Taf. A (without cornice), 113 ff, Taf. B (with cornice); Scheintür, 8-10. Wiebach has also provided a discussion of this feature, its date of appearance and meaning (*op. cit.*, 128-41).

2 *op. cit.*, 133-5.

3 Wiebach has arrived at a similar conclusion, *op. cit.*, 134.

4 For example, that of **h'-b3w-zkr** (Cairo, CG 1385; Murray, Saqqara Mastabas I, pl. I).

evolved by the end of the fourth dynasty.

The early fifth dynasty doors of **pr-sn**, **ny-'nh-shmt** and **w3š-ptḥ** all exhibit two jambs in an arrangement which becomes regular. An undecorated false door with two jambs seems to have been situated in the mortuary temple of Neferirkare at Abusir.¹ The decoration of the jambs of **pr-sn** is different from that of the other two examples (and from most doors of the fifth and sixth dynasties) in that the inner jambs feature several small registers with figures of his family. Members of the families of **ny-'nh-shmt** and **w3š-ptḥ** appear on their false doors but in conjunction with the large figure of the deceased.

The door of **ph-n-wi-k3i**, which has cornice and torus, has three jambs of varying width, only one pair of which bears a figure of the deceased. The inner ones bear elements of a palace-facade panelling design. That of **ntr-wsr** has two jambs without figures of the deceased. The inscriptions on each jamb, unlike the earlier examples, are of an even length, that is, they all terminate at the same distance from the bottom of the false door. The inscriptions on the door are all of similar length, although the arrangement in single columns is unusual.

The doors of the high officials of the reign of Djedkare and later (**pth-ḥtp I**, **'nh-izzi**, **3ḥt-ḥtp** and **pth-ḥtp II**) all exhibit jamb inscriptions of even length, with a figure of the deceased at the bottom of each. The doors of the two viziers **pth-ḥtp I** and **3ḥt-ḥtp** have three jambs, the others two. **pth-ḥtp II** unusually replaced the normal standing figure on the outer jambs with representations of himself carried in a palanquin and seated in a booth; **nfr-sšm-r'** is also seated in a booth on the inner left jamb of his false door.

The false doors of **hnmw-ḥtp**, **nfr** and **k3ḥ3i** are unlike these. The inner jambs are very wide and contain a large figure of the deceased (not unlike the style of the earlier part of the dynasty), but the outer jamb is narrow with one column of inscription only which reaches to the bottom of the door.

It is apparent in the fifth dynasty that as the cornice and torus were introduced, the inscriptions, size and decoration of the jambs of false doors became more regular: the length of the texts became even and the figures of the deceased on each jamb became equal in height. This development may be illustrated by the sequence of the doors of **ph-n-wi-k3i**, **ntr-wsr** and **pth-ḥtp I**. The number of jambs was not standardised, but may bear some relation to the rank or means of the owner, because the largest doors with cornice and torus seem at first to belong to viziers only (it will be noted that **pth-ḥtp II** does not bear the title of vizier on his false door). Officials of lower rank continued to use door types which owed more allegiance to early fifth dynasty examples.

Further door types may also be found in the fifth dynasty. Those of **h'-mrr-ptḥ**, **shḥm-'nh-ptḥ**, **k3i-pw-r'**, and **'nh-m-'-r'** have jamb inscriptions of even length with a figure of the deceased

1 Borchardt, **Nefer-ir-ke3-re'**, 30-1, Abb. 33, referring also to some fragments of a false door from the temple of Sahure.

below, but do not seem to have a torus and cornice.¹ The first two examples have three jambs, the others two. From this combination of features it should be concluded that the introduction of these false door features took place not suddenly but over a period of time. The torus and cornice concept, although it had been in existence for longer, took more time to become a standard feature of false doors than did the new layout of the jambs and their inscriptions. These false doors are therefore transitional examples and presumably belong to the middle and later fifth dynasty. None of them belongs to a vizier.

In the sixth dynasty, the false door with cornice, torus moulding and three jambs of equal length each with a similar disposition of texts became the standard type for all officials. Examples from the reign of Teti all exhibit these features. A similar pattern was followed down to the early part of the reign of Pepy II. Two doors of viziers however from this period employ only two pairs of jambs (**r'-wr, zzi**) showing some variation to be possible even for the highest officials.

In the reign of Pepy II, the false doors from the cemetery surrounding his pyramid at South Saqqara show changes from the above form. Two or three jambs are used, but they tend to be narrow with only one column of inscription each. The trend is towards a simplification of the door. The examples of **ny-ḥb-sd-nfr-k3-r'** and **tti** date from the end of the reign; that of **ḥnmw-ḥtp** cannot be dated so closely, nor can the additional examples of **nḥri, nfri, r'-ḥr-k3i** and **dgm**.² Some examples have an extra jamb and architrave outside the cornice.³ A figure of the deceased appears occasionally on the jambs, usually at the bottom of the second, or middle, one.

In summary, the practice of using unequal length jambs with figures of the deceased of varying size began in the fourth dynasty and continued at least to the middle of the fifth. At that time, the cornice and torus moulding began to make its appearance on the doors of the highest officials which brought with it the development of even length inscriptions and smallish figures of the deceased on the jambs. This latter feature is sometimes found in the later fifth dynasty without the cornice and torus. In the sixth dynasty the cornice and torus false door with this new style of jamb is the norm, but changes are apparent at South Saqqara in the reign of Pepy II. Jambs are therefore a more useful criterion for dating fifth than sixth dynasty false doors.

1 Respectively, Mariette, **Mastabas**, 118-20; Simpson, **Sekhem-ankh-ptah**, pl. B; Mariette, **op. cit.**, 278-9; **id., ib.**, 282-4.

2 Respectively, Jéquier, **Pepi II III**, fig. 62; **id., ib.**, fig. 62; **id., Tombeaux**, fig. 138; **id., ib.**, fig. 134.

3 For example, **ny-ḥb-sd-nfr-k3-r'**; also **nḥri, dgm** and **r'-ḥr-k3i** above.

This feature has assisted in the dating of the following:

iy (5)	ny-k3-r' (80)	k3i (136)
'nh-irs (25)	h3zi (98)	k3i-pw-r' (143)
bb-ib; sndm-ib (43)	h'-mrr-ptḥ (106)	dw3-r' (162)
m3-nfr (54)	sh̄m-'nh-ptḥ (124)	df3wi (167)
ny-k3w-ptḥ (77)	sšmw (127)	

C. The Panel

The overall shape of the panel shows relatively little change in the course of the Old Kingdom. In the fourth dynasty it is squarish, extended slightly to incorporate an offering list (**mtn**, **mry**, **šry**). In the early fifth dynasty, panels are sometimes extended to include a figure of the wife of the owner (**ny-'nh-sh̄mt**), or a second representation of himself (**w3š-ptḥ**). Panels of the middle and later fifth dynasty are again squarish (**ph-n-wi-k3i**, **ntr-wsr**, **'nh-izzi**), while those of the end of the fifth and early sixth show a tendency towards a slight elongation (**ptḥ-ḥtp II**, **mrrw-k3i**, **nfr-sšm-r'**, **hnty-k3i**). Some examples dating to the reign of Pepy I are indeed very elongated (**nfr-sšm-ptḥ** (later example), **r'-wr**, **ptḥ-šps**), although there are other approximately contemporary examples that are again squarish (**mḥw**, **zzi**, **mri**).

With the exception of the noted elongation in the reign of Pepy I, these variations are rather subtle. However, from the middle of the sixth dynasty to the First Intermediate Period there existed a panel shape which is quite distinctive and apparently confined to this period only:-

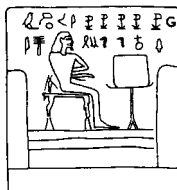

This will be referred to as the 'T' shaped panel. The earliest example (shown above) seems to be on the false door of **ppy-ddi**, found in the tomb of **hnty-k3i**.¹ The owner is presumably the son of **hnty-k3i** who bore the same name; the general style and workmanship suggest that it was not made along with the rest of the tomb, and so perhaps dates to the end of the reign of Pepy I, about the middle of the sixth dynasty. Other examples are found in the tombs around the pyramid of Pepy II at South Saqqara, such as the group discussed on the previous page, and there are obvious First

1 James, *Khentika*, pl. XLII.

Intermediate Period examples from the Teti Pyramid Cemetery.¹ That this form had ceased to exist by the early twelfth dynasty may be illustrated by the form of the false door of *ihy*,² although examples of the older form may also be found alongside this newer one.³

The most frequent scheme of decoration on the panel at all times is a seated figure of the deceased at the left-hand side facing right, with the left arm clasped to the chest and the right extended towards an offering table. The earliest exception to this is the panel of the false door of *w3š-ptḥ*, on which are found figures of the deceased on both the left and right-hand sides, facing each other. That on the right is in the reverse of the attitude described above, but that on the left has his left arm extended towards the table with the right on his lap.

The doors of *ph-n-wi-k3i* and *ntr-wsr*, probably quite close to each other in date, replace the table scene with three or four vertical columns of text. This feature seems to be confined to a short period in the middle of the fifth dynasty. In the later fifth dynasty, the usual attitude is found on the panels of '*nh-izzi*, *nfr*, *k3ḥ3i* and *hnmw-ḥtp*, although that of *ptḥ-ḥtp* II has the arms extended to the table rather than folded to the chest.

The oldest type of depiction is the most frequent in the sixth dynasty, the only exceptions among the well-dated examples being the panels of *s3bw*; *ibbi* and his son *ptḥ-špss*. The panel of *s3bw* has two figures, the left-hand of which has the less common of the two attitudes described above, and the right-hand one shows the deceased with his left hand extended to the table and the right holding a cup to his lips. This latter type is that found on the door of *ptḥ-špss*, only differing in that there it is on the left. This presumably shows a family or sculptural tradition.

There are more interesting variations found among the less well-dated examples. For instance, the panel of the door of *nn-ḥft-k3i*, on which his wife is also shown, depicts the owner on the right facing left (in conventional attitude).⁴ The doors of *k3i-pw-r'* and '*nh-m--r'*' also depict the deceased facing left.⁵ These two officials can date no earlier than the reigns of Djedkare and Menkauhor respectively, and their tombs are both quite close to each other. The panel of the false door of *ḥ'-mrr-ptḥ* is not dissimilar.⁶ These may all reflect a style current at the times their tombs were built (for further similarities see above pages 15-17).

1 The clearest are those that mention the pyramid of Merykare: *gmni-m-ḥ3t* (Firth-Gunn, *Teti Pyramid Cemeteries* II, pl. 27B), *ḥtpi* (Quibell, *Excav. Saqq.* (1906-7), pl. VI (2)), *inpw-m-ḥ3t* (*id.*, *Excav. Saqq.* (1905-6), pl. XV).

2 Firth-Gunn, *op. cit.*, pl. 83.

3 *ipi* (Quibell, *op. cit.*, pl. XIII), mentioning Merykare.

4 Cairo, CG 1484; Mariette, *Mastabas*, 307-9.

5 Respectively, *id.*, *ib.*, 278-9 and 282-4.

6 *id.*, *ib.*, 118-20.

Only two well-dated examples represent the wife of the deceased in addition to the owner himself, those of *šry* and *ny-'nh-šhmt*. Again, such representations are more frequent among the less well-dated examples: *tnti*, *k3i-ḥp*, *k3i-m-qdi*, *wr-ir-n-ptḥ*, *wr-dd-ptḥ*,¹ and *nn-ḥft-k3i* (see previous paragraph). It is likely that the whole group (with the exception of *tnti* who is clearly earlier) are of middle to late fifth dynasty date, the latest being *wr-dd-ptḥ*; his false door was found in the tomb of *k3i-m-snw* and *šḥpm*, whose dating is discussed in the Prosopography. One unusual example is the panel of *in-b3*.² The style of this panel is very similar to many of the poorer examples from Giza,³ and the owner was of much lower rank than those officials already mentioned.

It is not clear why a depiction of the owner's wife is found only occasionally. Expense in the saving of a separate false door may be one explanation (compare the aforementioned poorer examples from Giza). It may also show special respect or affection, particularly as many Old Kingdom tombs show no trace of the deceased's wife.

No example is known to the author of a door of the fifth or sixth dynasties with cornice and torus that represents the husband and wife together on the panel. This would seem to be more evidence for the greater standardisation of this type of false door.

There are at least two panels from Saqqara which show the deceased standing. These are *sšm-nfr*; *ḥb3* and *m3-nfr*.⁴ Both men were associated with the pyramid of Djedkare, and it is possible that they may have been close to one another in date. Both false doors have cornice and torus, and are overall rather similar, although that of *m3-nfr* employs two jambs to *sšm-nfr*'s three. There seems to be no further evidence of this panel feature at Saqqara, and it may have been an idea of the later fifth dynasty which did not meet with much acceptance and was not used thereafter.

The early examples of the loaves on panel offering tables are small, reaching only as high as the level of the deceased's chest (*mry*, *šry* and perhaps also *tnti*⁵). The normal fifth dynasty form, developed by the time of *ny-'nh-šhmt* and *w3š-ptḥ*, was for the loaves to reach the level of the shoulders or thereabouts. Late fifth and some early sixth dynasty examples show this still to be the case (*ptḥ-ḥtp* II and *s3bw*). However the panels of *mrrw-k3i* and *ḥnty-k3i* have offering loaves reaching level with the top of the head of the deceased, and this would seem to remain so until the reign of Pepy II, when the previous level was resumed (*mrrr*, *ny-ḥb-sd-nfr-k3-r*).⁶

1 Respectively, *id.*, *ib.*, 88-9; Martin, *Hetepka*, pl. 21; LD II, 100 c; *BM Stelae I*², pl. XXVIII; Firth-Gunn, *Teti Pyramid Cemeteries II*, pl. 62 (right).

2 Martin, *op. cit.*, pl. 25 (30).

3 Examples, Junker, *Giza XII*, 73, Abb. 4.

4 Respectively, Mariette, *op. cit.*, 399-400; LD II, 65.

5 Mariette, *op. cit.*, 88-9.

6 It has recently been suggested that this idea which originated as loaves on offering tables became understood as an image of a field of reeds, see Worsham, *JARCE* 16 (1979), 7-10.

The principal text on the panel is located above the head of the figure(s), and gives the name and one or two titles, usually in horizontal lines. Occasionally the text appears in vertical columns (**w3š-ptḥ**), perhaps due to the dictates of space.

The offerings that appear with the offering table are usually of the 'a thousand of' type, mainly bread, beer, alabaster, clothing, oxen and fowl. Extra elements are occasionally found, as in the case of **ptḥ-ḥtp II**. These offerings are usually located beneath the table of bread, but in some examples from South Saqqara they appear with the texts at the top of the panel (**ny-ḥb-sd-nfr-k3-r'**, **tti**). Representations of funerary equipment (chests, pots and the like) are only found from the second half of the fifth dynasty onwards (the panel of **hnmw-ḥtp** is one of the earliest examples), and the quantity that appears may to some extent be due to the amount of free space left on the panel after the rest of the decoration had been cut - for example, one may contrast the offerings on the square panels of **mrrw-k3i** and **hnty-k3i** with the oblong ones of **nfr-sšm-ptḥ** (later example) and **r'-wr**.

The general trend was thus for the panels of false doors to receive a wider variety of decoration as time progressed. However, the pose of the deceased on the panel was quite standardised except for a few isolated examples. Offering lists on the panel are discussed separately below.

Features of the panel design have been used in the dating of these examples:

ḥzzi (98)	k3i-pw-r' (143)
ḥ'-mrr-ptḥ (106)	ttw (160)
sšm-nfr; ḥb3 (132)	

D. The Panel Apertures

The terms 'narrow' and 'wide' will be used to describe individual examples, 'narrow' generally referring to those with a width of less than 15 cm.

The apertures of **mtn** do not appear to be very wide, but those of **mry** and **šry** are each almost half the size of the panel itself, and most importantly feature a palace-facade type decoration.

Examining the preserved fifth dynasty examples, one finds those of **ny-'nh-'shmt** to be wide (approximately 30 cm.), and decorated with depictions of his children. Children and offering bearers form the decoration of the even wider apertures of **w3š-ptḥ** (approximately 38 cm.). **ph-n-wi-k3i** (exact dimensions unable to be ascertained from publication) and **ntr-wsr** (approximately 27 cm.) employ wide apertures on their false doors, and those of the former are decorated with a palace-facade design. Similar decoration is found in the wide apertures of **hnmw-ḥtp** (approximately 19 cm.). Those of **nfr** and **k3ḥ3i** are also wide, varying approximately between 19 and 36 cm., and decorated with a mixture of the palace-facade design and depictions of children and dependents. In the later fifth dynasty however, it appears that the highest officials were tending towards the use of narrower apertures, for example those of

'nh-izzi and pth-htp II. That this was not yet standard practice is demonstrated by the variations among other false doors probably of the later fifth dynasty: the door of h'-mrr-pt \bar{h} has wide apertures (approximately 44 cm.), that of sh \bar{m} '-nh-pt \bar{h} narrow (approximately 15 cm.) but decorated ones, and those of k3i-pw-r' and 'nh-m-'-r' are narrow and undecorated.¹ In the sixth dynasty, narrow apertures seem to be the rule; the exact width varies but is nearly always too small to be decorated.

It is not clear exactly when the change from wide to narrow apertures took place, but the fact that it seems to coincide with the appearance of the cornice and torus moulding suggests that it might be part of a general move from the varying forms of the first half of the dynasty towards a new and more standardised one.

The appearance of small apertures is surely connected with the size of the jambs associated with different door types. The panel is normally situated on the lintel located on top of the inner jambs, and as one feature of the false door with cornice and torus was narrower jambs with fewer columns of inscription, the amount of space left after the panel was cut was more restricted.

Some of the panel shapes found from the late fifth dynasty onwards may be as a result of a deliberate effort to avoid wide apertures on the doors. If this be true, it suggests that the paramount feature to the officials of this time was the arrangement of the jambs, lintels and apertures. This might explain the inordinately large panel of s3bw; ibbi, perhaps designed to fill out the space left by the uncommon arrangement of both the inner and middle jambs 'supporting' the panel area; also the panel of nfr-s3m-pt \bar{h} could have been filled out with extra offerings to avoid leaving large apertures which were not the custom of the time. It is of course also possible that s3bw; ibbi wished to have a large panel on his door and the jambs were arranged accordingly.

This feature is of use in determining the date of the following:

'nh-m-'-k3i (31)	m3-nfr (54)	k3i-pw-inpw (141)
k3i-m-qdi (145)	bb-ib; s \bar{ndm} -ib (43)	sh \bar{m} '-nh-pt \bar{h} (124)

E. The Lintels and Architraves

1. Figures of the Deceased

The earliest depiction of the owner to appear on a lintel or architrave of a false door is that of ny-'nh-shmt (early fifth dynasty), who is shown seated at the left-hand end of both. w33-pt \bar{h} is represented on the right-hand end of his architrave, and also on the additional one above the offering list. The doors of ph-n-wi-k3i and ntr-wsr appear to have no figures at all on them, nor does that of hnmw-htp. pth-htp I is shown seated on the

1 Respectively, Mariette, *Mastabas*, 118-20; Simpson, *Sekhem-ankh-ptah*, pl. B; Mariette, *op. cit.*, 278-9; *id.*, *ib.*, 282-4.

lintel, while **3ht-htp** and **pth-htp** II appear only on the architraves, the former seated, the latter standing.

For the sixth dynasty, **s3bw; ibbi** is represented on the right-hand end of both elements, standing on the architrave and seated on the lintel. **hmt-r'** has a similar arrangement, but on the left. **mrrw-k3i** and **hnty-k3i** are not shown on the lintels of their doors, although the smaller doors of the latter have a standing figure on the left-hand side of the architrave; **pth-špss** appears standing on the left side of the lintel, **r'-wr** is seated on the left of both, **mrrr** stands on the left of the architrave and **zzi** is seated on (at least) the left of the lintel. Figures on either element of false doors from South Saqqara are very rare - a notable exception may be found on that of **nhri**,¹ probably because of the presence of an offering list.

The depictions on the architrave and lintel seem to assume the same orientation as the figure on the panel, and where there are two figures, that on the lintel/architrave is probably aligned with the more important one.²

Standing figures of the deceased do not seem to appear before the later fifth dynasty, and tend to be the more common form on the architrave during the sixth dynasty. Overall, figures are found more frequently on the architrave than the lintel.

2. The texts

The earliest doors from Saqqara do not divide the texts on the lintel and architrave into horizontal lines in the manner of later practice. The orientation of these texts, once a reasonably consistent pattern for the design of false doors had been established, usually follows that of the figures (if any) at the end. If there is no such figure, the texts face in the direction of the figure on the panel (**mrrw-k3i**, **hnty-k3i**), or, as found on some fifth dynasty lintels, there may be two such texts which begin in the centre, reading ← →, or which begin at the outer ends and read → ← (**ph-n-wi-k3i**, **pth-htp** II).

Such criteria as based on lintels and architraves have been useful for dating **3ht-htp** (4).

1 Jéquier, **Pepi II III**, fig. 62

2 A good illustration of this may be found on the door of **nn-hft-k3i**: the lintel/architrave figures are to the right facing left, thus emphasising his position rather than that of his wife (Cairo, CG 1484; Mariette, **Mastabas**, 307-9).

F. Smaller Features

1. Relief.

The fourth dynasty material (mtn, mry, šry) is decorated in raised relief, and of the well-dated examples from the early and middle fifth dynasty, only those of w3š-pth and pth-špsš seem to have been decorated in sunk relief. That sunk and raised relief existed alongside each other is shown by the employment of both types in the doors from the tomb of nfr and k3h3i. Towards the end of the dynasty, sunk relief began to be used by the most important individuals, for example, nbt, a wife of Wenis.¹

In the sixth dynasty, all the false doors that can be certainly dated to the period are cut in sunk relief. To summarise: raised relief was the norm in the fourth and the greater part of the fifth dynasties for the doors of the most important officials, who form the bulk of the examples used here. Sunk relief began to be used at least by the time of Neweserre, and gradually became the predominant form by the end of the fifth dynasty.

Some of the sunk relief of the fifth dynasty may be attributed to the need for speedy completion of the monument. The tomb of w3š-pth was built for him by his son, as was that of dw3-r' at Dahshur, also in sunk relief.² Perhaps the quicker execution of sunk relief and the consequent cheapness may account for the change in the sixth dynasty, but it is more likely that it came to be used for the most important parts of the tomb, those which would identify its owner, and which it was essential to protect against damage or usurpation. Thus offering lists were often cut in sunk relief while the rest of the decoration was raised, for example on the false door of hnmw-htp.³ Therefore, although sunk relief was not a feature that first appeared in the design of the new false door with cornice and torus, it gradually became an accepted part of the design.

This feature has been of assistance in the dating of:

'nh-m-'-k3i (31) k3i-pw-inpw (141) ty (157)

2. Decoration of the Central Niche.

Excluded deliberately under this heading are the offering lists discussed below. The decoration most commonly found in this niche consists of one column of text, comprising names, titles or offering formulae, which appears in the middle fifth dynasty, well-dated examples being pth-špsš, ph-n-wi-k3i, ntr-wsr, hnmw-htp and pth-htp I. It does not seem to be found on any doors of certain late fifth to sixth dynasty date, and is thus a feature not normally

1 Fischer, JEA 60 (1974), 94-5, fig. 1; relief type obtained from examination of original.

2 Cairo, CG 1389.

3 Petrie-Murray, Memphite Tomb Chapels, pl. XVI.

associated with cornice and torus doors with the exception of some early examples. This feature also occurs on the less well-dated false doors of **k3i-m-nfrt**, **hṭp-k3i**, and **ny-'nh-r**.¹

The original inspiration for this feature is uncertain. It may perhaps be derived from the figure of the deceased surmounted by a text found in the central niche of doors of the fourth and early fifth dynasties (**mry**, **šry** and probably **'nh-irs**²); these may also have inspired decoration such as that of **h'-b3w-pth**,³ whose door niche has three columns of titles, his name and a figure.

This feature has been used to assist dating **h'-inpw** (101).

3. The Incorporation of Additional Scenes

Examples of this are not common. Certain doors from the early fifth dynasty include representations of children with or below the figures of the deceased (**ny-'nh-šhmt**, **w3š-ptḥ**), but the above heading is intended to cover those doors of which a complete jamb or more is devoted to scenes which more normally find their place on other walls of a tomb.

The earliest such example is the door of **pr-sn**, the inner jambs of which each contain four representations of children or dependents. Most others are less well-dated. That of **k3i-ḥp** has many representations of offering bearers and dependents on the jambs.⁴ The outer jambs of the false door of **zṭw** are composed of five registers of butchers and offering bearers;⁵ below the large figures on the door of **df3wi** are three registers of offering bearers and butchers;⁶ and the large outer jambs of the false door of **šhm-k3i** contain similar scenes, with the addition of seated figures of the deceased at the top.⁷ In all but the example of **pr-sn**, the false door forms the sole decorated surface in the tomb, and these scenes are in fact those that are almost obligatory in any Old Kingdom decorated tomb-chapel, namely offering bearers and butchers.⁸ Thus the false door contained all the essential elements of a tomb.

With the exception of that of **pr-sn**, these doors are all examples of the older type, with wide jambs and very large figures of the deceased. Such a similarity of design suggests that they may be all of kindred date, perhaps middle to later fifth dynasty,

1 Respectively, Mariette, **Mastabas**, 247-9; Martin, **Hetepka**, pl. 14; **BM Stelae I**², pl. XXVI (BM 658, 1429B).

2 Mariette, *op. cit.*, 109.

3 *id.*, *ib.*, 295.

4 Martin, *op. cit.*, pl. 21.

5 From an examination in November, 1981; cf. Mariette, *op. cit.*, 302-3. Small part, Spencer, *JEA* 68 (1982), Pl. II (2).

6 Petrie-Murray, **Memphite Tomb Chapels**, pl. XIV.

7 Murray, **Saqqara Mastabas I**, pl. VII.

8 It will be noted that one other important element, the offering list, also appears on the false doors of **df3wi** and **šhm-k3i** (below).

after which certain of the false door features they exhibit disappear.

This feature has been useful for dating:

ztw (115) wr-k3-ptḥ (41) df3wi (167)

G. The Incorporation of Offering Lists into False Doors

Two types of offering list are found. The first consists of a list not arranged according to what will be termed the 'canonical list', and the second lists that are. The order of the canonical list is discussed principally by Barta,¹ and this form was followed, with certain additions, from the early part of the fifth dynasty (a little later than at Giza) until late in the sixth.

1. Uncanonical Offering Lists

Such examples are only ever found on the panel of the false door, and they can be further divided into two sub-groups, those which antedate the introduction of the canonical list and those which exist alongside it. The former type is more common at Giza than at Saqqara. These early panel lists serve the same function as the later canonical lists (to provide the deceased with an idealised set of offerings to replace the real ones should they cease), and their increasing complexity in the fourth dynasty may be illustrated by comparing the examples of mtn and mry. More developed examples may be found on the panels of ḥwti, tnti, 'nh-irs, and k3i-'pr,² all of which would seem to date from the late fourth to early fifth dynasty, antedating the canonical list which makes its first Saqqara appearance in the tomb of w3ḫ-ptḥ.

The second sub-group of offering lists is much more selective in its choice of elements, consisting principally of the seven sacred oils. The earliest well-dated occurrence of this is on the panel of ny-'nh-shmt, of the reign of Sahure. Other examples come from tombs which cannot be as easily dated. Table 3 attempts to illustrate the range of these items; the examples in this table are not necessarily in order of date. It is clear that, in addition to oils, these short lists sometimes include cosmetics and certain agricultural products, but items in the latter category do not appear very often and in no consistent pattern by date - ntr-nfr is usually dated to the sixth dynasty (Cairo Catalogue), while that of spdw-ḥtp is uncertain but perhaps mid-fifth dynasty (below, in the Prosopography under ḥ'-mrr-ptḥ (106)). These have a degree of affinity with the pre-canonical lists mentioned above. Most of the

-
- 1 **Opferliste**, 47-88, particularly the table on pages 47-40. A less systematic presentation is given by Hassan, *Giza VI*², *passim*.
 - 2 Respectively, Cairo, CG 1392; Mariette, *Mastabas*, 88-9; *id.*, *ib.*, 109-10; Fischer, *JNES* 18 (1959), pl. IV.

Table 3

Principal Component Elements of Short Offering Lists

	1	2	3	4	5	6	7	8	9	10	11	12	13
nn-hft-k3i ^a		X	X	X	X	X	X						1)
'nh-m3' ^b		X	X	X	X	X	X						
ntr-nfr ^c	X	X						X	X	X	X	X	
wr-ir-n-ptḥ ^d	X	X	X	X	X								
k3i-m-nfrt ^e		X	X	X	X	X	X						
k3i-m-qdi ^f	X	X	X	X	X								
k3i-hp ^g	X	X	X	X	X	X	X						
spdw-htp ^h												X	2)
nwb-htp ⁱ	X	X	X	X									1)
ty ^j		X	X	X	X	X	X						

Key to Columns:

1	sntr	2	sti-hb	3	hknw
4	sft	5	nhnm	6	h3tt
7	tw3t	8	msdmt	9	w3dt
10	w'h	11	irp	12	d3b
13	Others:	1)	ztw		
		2)	sht hdt, sht w3dt, hbnnt, š't, dšrt		

References:

- a Cairo, CG 1484; Mariette, **Mastabas**, 307-9.
 b Cairo, CG 1465. c Cairo, CG 1447.
 d **BM Stelae I²**, pl. XXVIII. e Mariette, **op. cit.**, 247-9.
 f LD II, 100 c. g Martin, **Hetepka**, pl. 21.
 h Mariette, **op. cit.**, 211. i Cairo, CG 1415.
 j Epron-Wild, **Le tombeau de Ti III**, pl, CLXXXII, CLXXXIV

other individuals probably date to the period around the middle of the fifth dynasty, notably **nn-hft-k3i** who is probably depicted in the mortuary temple of Sahure.¹ The most questionable conventional date is Baer's assignation of **k3i-m-nfrt** to his period VI E,² as this tomb exhibits more features of fifth dynasty date, for example the jambs, apertures and relief of the false door. The example of **ty** is in many ways the most interesting of the group, as his is the only door of the newer design with cornice and torus to bear any type of offering list. His date is by no means certain, but such a mixture of features associated with older and newer door styles suggests that his example was made during a period when the newer

1 Borchardt, **S'a3hure'** II, Bl. 17 (top left).
 2 Early to middle reign of Pepy II, **Rank and Title**, 142 (523).

type had only just come into use, which was, as seen above, around the middle of the fifth dynasty.

It is thus suggested that the use of small uncanonical offering lists of this type was a feature of the middle of the fifth dynasty, from perhaps the reign of Sahure or Neferirkare to that of Djedkare, with sporadic examples from slightly later times.

2. Canonical Offering Lists

The origin and development of the canonical list cannot be seen as clearly at Saqqara as at Giza, whence comes more material of the formative stages in the fourth and early fifth dynasties (below Chapter 2.II.B). In all the very early Saqqara offering lists, the selection of the individual offerings shows a large degree of fluctuation, which was drastically reduced by the advent of the canonical list. The linen list had established itself on the right of the panel by the time of **mtn**, but it seems to have ceased to be a part of the decoration of the door by the end of the fourth dynasty, from which period probably come the additional examples of **ms-z3**, **tnti**, **hwti**, and **k3i-'pr** (see above page 26).

The canonical list seems to have made its debut at Saqqara above the architrave of the false door of **w3š-pth**, a little later than its appearance at Giza. It is usually considered that the 'normal' position in the Old Kingdom for the large canonical offering list is on one of the walls of the chapel adjacent to the false door. There are however no examples of this practice at Saqqara until the reign of Neweserre at the earliest (**ntr-wsr**¹), and it is therefore likely that the offering list was located on the false door for a while after its first appearance at Saqqara. All early examples of such lists are found in the tombs of very important officials, as seems to have been the case with most important developments, such as the door with cornice and torus moulding.

The tomb of **ntr-wsr** is also among the first to use this newer design of false door. There does not seem to be a single example of such a door with cornice and torus which bears a canonical offering list on any of its parts, whereas we will see that they are not uncommon on the older pattern of door. The new door and the canonical offering list seem to have been mutually exclusive.

As the false door without cornice and torus continued in use until the later part of the fifth dynasty, it is likely that offering lists on such doors will date to a similar period, from the reign of Neferirkare at the earliest to some point near the end of the dynasty.

Such offering lists are found on most parts of the false door, with the largest number being on the panel. It is evident that in most cases the jambs would receive a full list and the panel an abbreviated one, logical in terms of the space available.² In only

1 Murray, **Saqqara Mastabas** I, pl. XXI, XXIII.

2 Some full jamb lists: **ny-'nh-r'** (**BM Stelae** I², pl. XXVI(2, 3)), **itti**; **'nh-irs** (Murray, *op. cit.*, I, pl. XVIII). That of **r'-mry-ptḥ** is partly in the central niche (Mariette, **Mastabas**,

the example of **ty** is there a short panel list and a jamb list, although that of **3ht-htp** does begin on the panel and is continued on the right outer jamb.¹ The only full panel lists are those of **shm-k3i** and **htp-hr-3ht**, and probably **nh-t-z3s** and **hnmw-htp** (when restored - the latter two lists extend onto the right-hand panel aperture).² When placing a list on the panel, the most important part of the list was clearly the first twenty or so elements, comprising the oils, cosmetics and royal offerings.

We can only guess at the reasons prompting one arrangement in favour of another. Most often, lists were carved on the door since this was the only surface in the tomb to be decorated.³ Otherwise, the restriction of the offering list to certain areas must have been due to the particular requirements of the owner for decoration elsewhere, and also to current practice. In fact the unique position for an offering list on the lintel of **h'-mrr-ptḥ** may have been due to his concern not to interfere with the arrangement of the jambs in the style of the new false door - even length inscriptions and a figure of himself at the bottom of each jamb.⁴

Precise dating of most of the examples quoted above is not really possible without the use of further criteria, and the reader is referred to general discussions of date, such as those in Baer, **Rank and Title**, from which it does not seem unreasonable to place most of them in the period of the reigns of Neferirkare to Djedkare, the earliest being that of **ty**, and the latest probably **h'-mrr-ptḥ** and **itti; 'nh-irs**.

This discussion of offering lists has been of assistance in the following cases:

izi (17)	ny-k3i-'nh (75)	k3i-pw-inpw (141)
itti; 'nh-irs (21)	h'-mrr-ptḥ (106)	k3i-m-qdi (145)
'nh-irs (25)	k3i (136)	ty (157)
'nh-m-'-k3i (31)	k3i-'pr (139)	dw3-r' (162)

H. The Relationship of False Doors and Chapel Types

By examining the changes in chapel types and the classes of false door found in them, it may be possible to establish some sort of relationship by date of these two features. A summary of overall

154-5).

Some abbreviated panel lists: **ny-k3i-'nh** (Petrie-Murray, **Memphite Tomb Chapels**, pl. III (middle)), **df3wi** (id., *ib.*, pl. XIV).

- 1 Respectively, Cairo, CG 1380 and Zayed, **ASAE** 55 (1958), 130-1.
- 2 Respectively, Murray, *op. cit.*, pl. VII; Boeser, **Leiden** I, Taf. XVII-XVIII; Mariette, *op. cit.*, 366; Cairo, CG 1423.
- 3 Only in the tomb of **hnmw-htp** is there another offering list in addition to the one noted above on the door (Petrie-Murray, *op. cit.*, pl. XVII(1)).
- 4 Mariette, *op. cit.*, 118-20.

developments in chapel design in the course of the Old Kingdom is given by Baer.¹ Most of the chapels discussed below belong to the officials whose false doors have been used as the basis of the preceding discussion.

1. Summary of Principal Chapel Types

In the fourth dynasty, the plans of chapels seem to be of what is known as the true cruciform type, to be found, for example in the tombs of **mtn** and **ph-r-nfr** (figure 2.a and b). Examples from the early fifth dynasty show a wider range of chapel types. The modified cruciform and 'L'-shaped chapels made their appearance, for example in the tomb of **k3i-'pr** (figure 2.c), but the cruciform chapel was still in evidence (that of **'nh-irs**, figure 2.d). Another new type is the east-west chapel, found in the tomb of **pr-sn** (figure 2.e). The principal orientation of chapels prior to this was north-south, and the new type was thus a major innovation.

In the middle of the dynasty, the cruciform chapel was still used (**pth-špss**, figure 2.f), but the east-west form became more frequent. There seem to have been two variants on this scheme, one with the main offering room at the end of a north-south corridor (**ty**, figure 3.a), and more complex ones in which the main room was reached through other smaller ones, as in the examples of **ph-n-wi-k3i** and **ntr-wsr** (figure 3.b and c).

The well-dated tombs of the later fifth dynasty show an increasing tendency towards the use of the complex and east-west chapels, as may be found in the mastabas of **pth-htp I** and **3ht-htp; hmi** (figure 3.d and 4.b), but with others still of the north-south type (**'nh-izzi**, figure 4.a).

The east-west chapel became the principal form in the sixth dynasty. The extent of the complexity of the tomb-plan presumably depended on the status and means of the tomb-owner. The tombs of **k3i-gmni**, **mrrw-k3i** and **hnty-k3i** are good examples of very complex chapels (figure 4.c and figure 5.a). However, as may be seen from the chapel of **r'-wr**, older forms still existed, even in the tombs of the very highest officials (figure 5.b). Little has been preserved of the chapels from the cemetery of Pepy II at South Saqqara to enable conclusions to be drawn about the plans of tombs built there.

2. Relationship of these Chapels to the False Door

The most far-reaching development in chapel design in the fifth dynasty was the introduction of the east-west offering room. The majority of such chapels contain the new type false doors with cornice and torus moulding, while most of the older false doors are found in north-south chapels. Like the new false door, it is possible to trace the origin of the east-west chapel to a royal monument. An elongated example of such a chapel seems to have been

1 Rank and Title, 48-9, with references.

Figure 2: Plans of Offering Rooms in Saqqara Chapels (1)

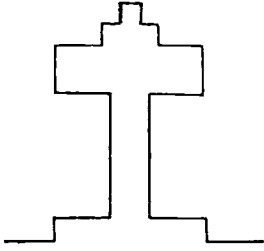

a. From **PM 3²**, pl. XLIX

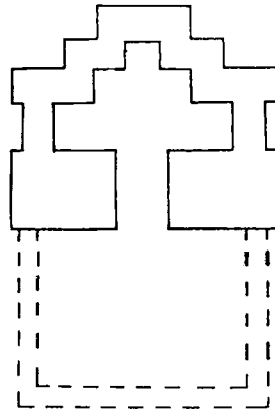

b. From **PM 3²**, pl. L

—————> N

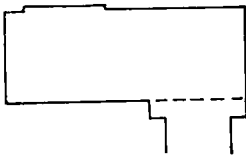

c. From **PM 3²**, pl. XLIX

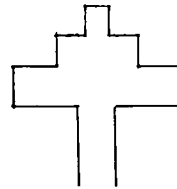

d. Drawn from Mariette, **Mastabas**, 109

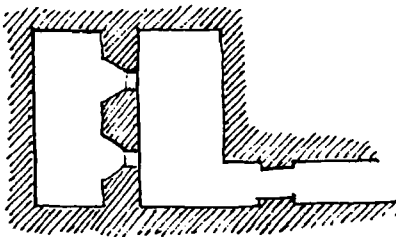

e. Mariette, *op. cit.*, 299

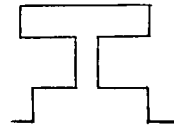

f. Drawn from Mariette, *op. cit.*, 111

Plans are not necessarily to the same scale

Figure 3: Plans of Offering Rooms in Saqqara Chapels (2)

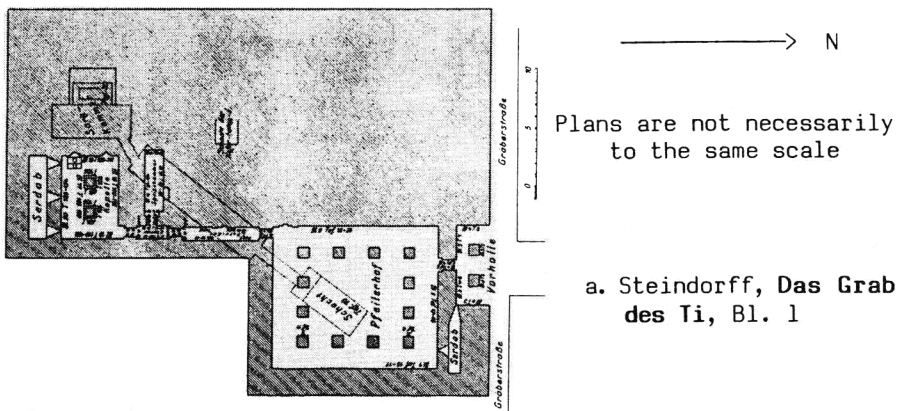

a. Steindorff, Das Grab des Ti, Bl. 1

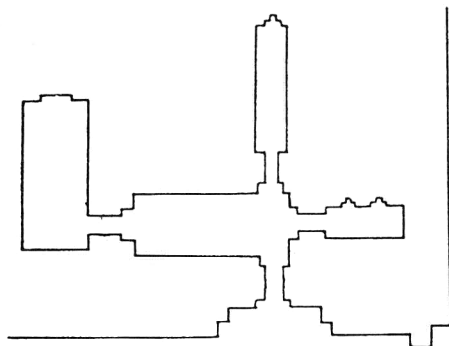

b. From PM 32, pl. XLIX

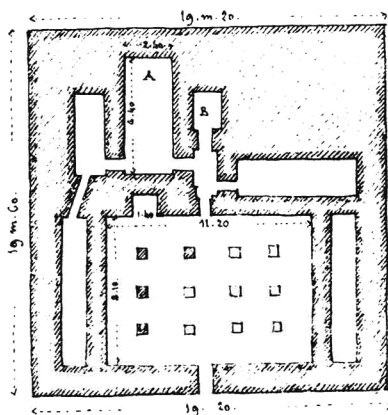

d. Mariette, Mastabas, 351

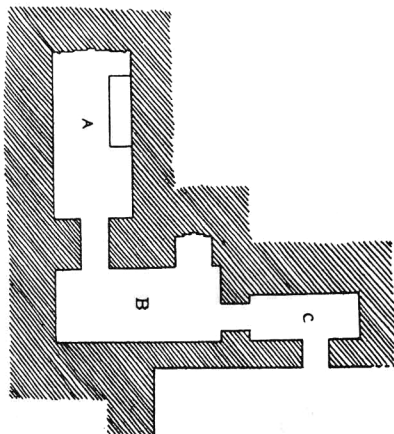

c. Murray, Saqqara Mastabas I pl. XXXII

Figure 4: Plans of Offering Rooms in Saqqara Chapels (3)

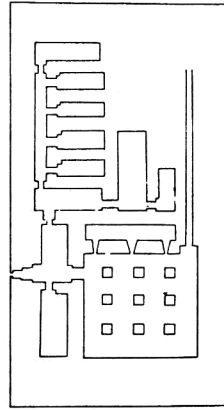
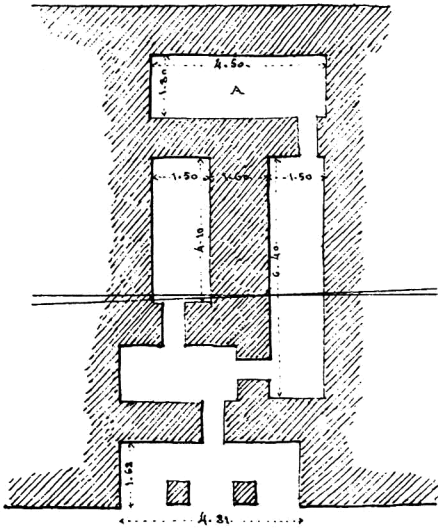

a. Mariette, *Mastabas*, 190

b. From *PM* 3², pl. LXIV

c. From Firth-Gunn, *Teti Pyramid Cemeteries II*, pl. 51

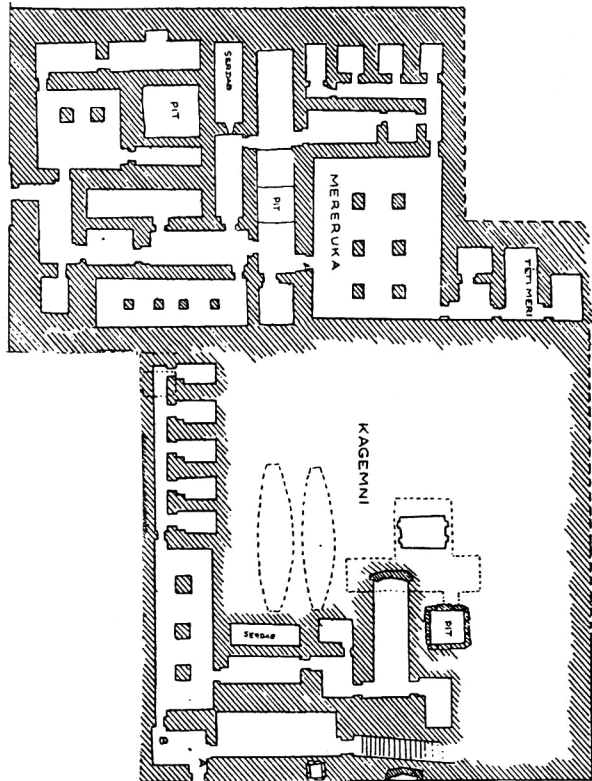

Plans are not necessarily to the same scale

Figure 5: Plans of Offering Rooms in Saqqara Chapels (4)

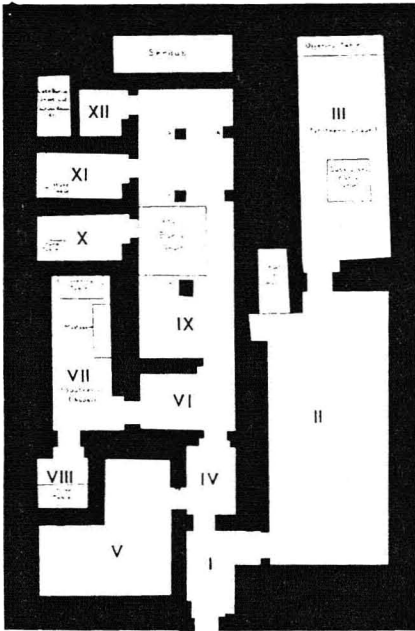

a. James, *Khentika*, pl. III

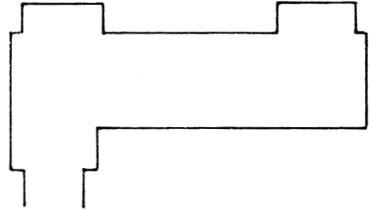

b. Drawn from el-Fikey, *The Tomb of the Vizier Re'-wer at Saqqara*, fig. 2

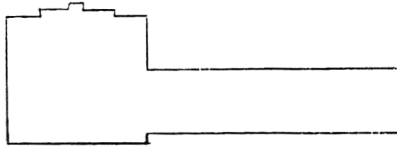

c. Drawn from LD Text I, 142

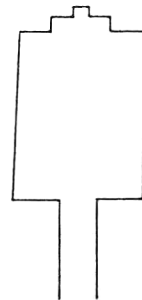

d. Drawn from Petrie-Murray, *Memphite Tomb Chapels*, pl. XXIV

Plans are not necessarily to the same scale

the central feature of the Menkaure pyramid temple,¹ and an abbreviated version appears also in the temple of the Mastabat Faraoun.² The standard location for this chapel and the false door seems to have been established in the mortuary temples at Abusir.³ It is thus highly probable that such a scheme evolved in royal monuments, and shortly afterwards began to be used by the highest officials, and later all ranks of tomb owners.

The new chapel type and false door form are thus closely associated. False doors must be included in this group which resemble the newer ones in all respects except their lack of torus and cornice (examples above pages 16-17). There are several other chapels of the east-west type which contain false doors of the older form, for example that of df3wi (figure 5.d). The door in this tomb contains an offering list on the panel and so cannot be considered to be of the new type. The chapel is a very simple one, but shows the outlines of the east-west type in its overall shape.

Perhaps another variant of the east-west offering room is to be seen in those chapels which consist of a small square room at the end of a corridor, as in, for example, the tomb of s3mw (figure 5.c).⁴ These are similar to that of ty above (figure 3.a), but are simpler. In most of these tombs, the offering room is not very long, perhaps suggesting that the room was the east-west chapel at a very early stage of development.

I. Summary of Principal Conclusions

The frequency with which the above criteria are used in this work justifies the following summary:

Torus and Cornice: This appeared in the early fifth dynasty, and is found mainly from the reign of Neweserre. Until the later fifth dynasty it is confined principally to viziers and high officials. It became the usual type in the sixth dynasty.

Jambs: One or two pairs normal in the fourth to middle fifth dynasties, usually wide and decorated with a very large figure of the deceased, often with the addition of figures of his family. There were several columns of text per jamb, the length of which varies on different jambs. After the mid-fifth dynasty, jambs became narrower and of equal length and width; the figure of the deceased became smaller. Three pairs are found with the highest officials. This type is usually,

1 Brinks, *Die Entwicklung der k3niglichen Grabanlagen des Alten Reiches*, Taf. 8.

2 *id.*, *ib.*, Taf. 10.

3 *id.*, *ib.*, Taf. 12, 13, 15.

4 Comparable examples may be found in the tombs of tp-m-'nh (Mariette, *Mastabas*, 196), htp-k3i (Martin, *Hetepka*, pl. 4) and pth-wsr (Mariette, *op. cit.*, 115).

Chapter 2.I.I - Summary

but not always, found with the torus and cornice. Two or three equal width jambs were normal in the sixth dynasty. In the reign of Pepy II, jambs became very narrow, usually with only one column of text.

Panel: Squarish for most of the Old Kingdom. In the period of the reign of Teti to Pepy I, some examples are very elongated. From the middle sixth onwards they are often 'T'-shaped, particularly in the reign of Pepy II. They were normally decorated with a seated figure of the deceased at the left. The deceased's wife appeared on some fifth dynasty panels. Some middle fifth dynasty examples replaced the normal table scene with a text. Later fifth ones occasionally showed the deceased at the right side of the panel and sometimes in a standing position.

Apertures: Wide from the middle fourth to middle fifth dynasties, in which period they were frequently decorated. Most doors with torus and cornice have narrow apertures, especially from the late fifth dynasty onwards.

Lintels: If present, the figure of the deceased followed the alignment of that on the panel. Some standing figures are found in the later fifth dynasty. Early texts are not split into distinct lines.

Relief: Generally raised until the later fifth dynasty, thereafter sunk. Sunk relief became associated with torus and cornice doors.

Central Niche: The use of a vertical column of text is a feature of false doors of the mid-fifth dynasty.

Extra Scenes: Not common, confined to the early to middle fifth dynasty. Not found on doors with torus and cornice.

Offering Lists: The presence of these on false doors generally indicates a period before the later fifth dynasty. Not found with torus and cornice doors. Short lists on the panel of an uncanonical nature are confined to fourth to mid-fifth dynasty examples. Canonical lists may appear almost anywhere on the door and usually belong to the period of the reigns of Neferirkare to Djedkare.

Chapel Types: In the fourth dynasty, cruciform chapels with deep niches were normal. The 'L'-shaped chapel appears in the early fifth dynasty. Both these chapel types usually contained the older-style false doors. The first developments in the direction of the east-west chapel appeared in the early fifth dynasty. False doors of both older and newer types are found in these chapels. The east-west chapel

gradually took precedence from the middle fifth onwards, especially in the tombs of the highest officials, although the older types are still found. In the late fifth and sixth dynasties, the east-west chapel was the norm, with the torus and cornice false door; chapel plans were often very complex.

Section II: False Doors and Other features of Tomb Design at Giza

A. Introduction

The nature of the material from Giza, and the extent of its relevance to the subject of this work, necessitates a different treatment from that given to doors from Saqqara. At the latter site, the officials in question were generally of the higher ranks, and their spread is relatively consistent from the middle fifth dynasty to the end of the Old Kingdom. At Giza, however, the majority of relevant officials buried there date to the fourth and early fifth dynasties, after which period the number declined; the majority of burials after this time were of lesser men, particularly in the sixth dynasty. As the purpose of this study is to shed more light on the dating of the highest officials of the Old Kingdom, it is apparent that the site of Giza must receive attention principally for the earlier period; examples of false doors from later times will be discussed at less length.

B. The Offering List in the Fourth and Fifth Dynasties

At Giza, we encounter the problem that there are fewer tombs that can be independently dated than at Saqqara, and it is thus not possible to produce a list of examples of the fourth and early fifth dynasties around which to build groups of similar false doors. To obtain a possible sequence for the chapels under consideration, it is necessary to utilise other features, the most prominent of which is the offering list found in most chapels of the period in question. This discussion works from the premise, which however may not always be correct, that a particular design practice would become more complex as time progressed.

The early development of the offering list at Giza may be seen on the slab-stelae: it would seem likely that the number of elements in these offering lists increased with time, the earliest examples, those from cemetery G1200, such as **k3i-nfr** (G1203)¹, having but five, while later ones had many more, such as that of **wp-m-nfrt** (G1201 - twenty) and **sš3t-shntyw** (G2120 - thirty or more).² Common to them all is the presence of a linen list.³ The tomb of the last-mentioned example has a mason's graffito of the

1 Reisner, *Giza I*, pl. 17b.

2 Respectively, *id.*, *ib.*, pl. 17a and 39a.

3 For this feature, see Smith, *ZAS* 71 (1935), 134-49.

twelfth cattle-count of an unnamed king. This is probably of the reign of Khufu, and if the main body of the mastaba were built at the end of that reign, then the decoration is unlikely to be earlier than the beginning of the reign of Khafre.¹

Similar in some respects to the slab-stela of **sš3t-shntyw** is the panel of **nfr** (G2110); the major difference is that it is incorporated into a false door.² These resemblances may suggest a date for **nfr** shortly after that of **sš3t-shntyw**, perhaps in the middle of the reign of Khafre.

It must be stressed that none of these can be referred to as being a 'canonical list', that is, the form which becomes the standard order in the fifth and sixth dynasties (see further above page 28). It is clear that at some point between the early fourth and the middle fifth dynasty the change from the older to the newer style of list came about. At Saqqara this was considered to have happened in about the reign of Neferirkare, but, as will be seen, the change began at Giza.

The earliest examples of lists with resemblance to the canonical one come from the Eastern Cemetery, from the tombs of **h'f-hwfw** I (G 7130 + 7140) and **mrs-'nh** III (G7530). On the grounds of the former being a son of Khufu, it is unlikely that he would have decorated his tomb before the reign of Khafre. **mrs-'nh** perhaps married Khafre and may have died at the beginning of the reign of Shepseskaf, and so the decoration of her tomb probably dates to the reign of Menkaure.³ The lists of **h'f-hwfw** are found on the panel of his false door and the south wall of the chapel.⁴ Closer examination reveals that the two are complementary; using the numbers of the canonical list of Barta,⁵ the first fifteen elements are absent, but numbers sixteen to fifty-nine, with a few omissions, are in canonical order on the panel. The majority of elements sixty to ninety are found on the south wall, with perhaps six of them also featuring on the panel. There can be little doubt that this is a canonical list, and also that it shows signs of being very much an experiment. The conventional position of the list before this time was solely on the panel, but in this case to accommodate the number of elements required it had to be continued elsewhere. The lack of certain of these shows that the form was still very fluid. Both of these lists are arranged so that no physical divisions were placed between the individual elements, in common with the older examples.

The list of **mrs-'nh** III shows a further development. This is found on the south wall of Reisner's room b of her tomb,⁶ and comprises virtually all the elements of a standard offering list. Each element is for the first time placed in a small 'compartment'.

1 *id.*, JNES 11 (1952), 127 (3), fig. 6 (G2120).

2 Reisner, *op. cit.*, fig. 241.

3 Dunham-Simpson, **Giza Mastabas** I, fig. 2; a less likely suggestion is that she died at the beginning of the reign of Menkaure, *id.*, *ib.*, 7-8.

4 Simpson, **Giza Mastabas** III, fig. 32, 31.

5 **Opferliste**, 47-50.

6 Dunham-Simpson, *op. cit.*, fig. 9.

Further late fourth dynasty examples are found in tombs in the Khafre Quarry Cemetery, notably those of **ny-k3w-r'**, **dbhn**, and **shn-k3-r'**,¹ which belong to the reigns of Menkaure to Sahure. This shows clearly that the development of the offering list in its canonical form took place in the tombs of members of the royal family. The exception to this is that of **dbhn**, but, as his biography shows,² this tomb and its site were given to him specially by Menkaure as a favour, and consequently it should be regarded as one would a royal tomb.³

The earliest canonical list that is evident from independently dated private tombs is that of **s5m-nfr** I (G4940), perhaps of the reign of Sahure or Neferirkare. There are several private non-canonical lists that seem to belong to the preceding period. Panels with offering and linen lists not dissimilar to that already noted in the tomb of **nfr** are also found in that of **mry-ib** (G2100-I-annexe).⁴ There is an important false door panel from cemetery G4000, that of **snfrw-snb** (G4240).⁵ This is significant as the linen list is omitted, and the decoration of the panel consists solely of about seventy-six individual offerings. This number is far higher than any previously found in a private tomb at Giza, and was clearly the next logical step from the panels of **nfr** and **mry-ib**. This list is not in a canonical order; the content and grouping of the elements is not unlike that of the later lists, but some items appear which do not survive in the canonical list, such as the **smn** goose and the **prw** drink. Given that **snfrw-snb**'s mastaba contained a 'reserve head', it is likely that his tomb is not one of the latest ones in the cemetery, but may perhaps be of the period of the reign of Khafre to that of Menkaure, as may be **mry-ib**.

In the tomb of **dw3-n-r'** (G5110, unpublished), the only offering list appears to be that on the panel of the false door. It contains approximately twenty-three elements arranged in an uncanonical order. At the end of the first line of the offering list,

- 1 Respectively, LD Erg., Taf. XXXV; LD II, 35; Hassan, Giza IV, fig. 122; LD II, 42 c; Hassan, *op. cit.*, fig. 63.
- 2 *Urk.* I, 18-21.
- 3 Other offering lists of members of the royal family of the fourth dynasty use the older style. These are all from the Eastern Cemetery and their owners were thus probably related to Khufu and were very likely earlier than the individuals noted in the Khafre Cemetery. Those of **h5p-hrs**, the wife of **'nh-h3f** (G7510, unpublished), and **mrt-itis** (G7650, unpublished) are the only ones with linen lists. Unpublished fragments of the list of **ddf-hr** (G7210 + 7220) suggest that it may have been not unlike that of **h'f-hwfw**. For others see the list in Reisner, Giza I, 334-5. It is clear that a large degree of variation was indeed possible in the middle fourth dynasty, as one might expect given the number and pace of current developments in the list.
- 4 LD II, 19.
- 5 Reisner, *op. cit.*, pl. 57b.

there is a falcon on a perch, presumably to be read *idmy* 'red linen', thus providing a link with the old linen list which by this time had disappeared from the tomb.¹ This form of list suggests that it was not one of the older examples in the cemetery, having affinities as it does with those of *mry-ib* and *snfrw-snb*.

There are at least three further tombs from the western field at Giza, conventionally dated to the early fifth dynasty, which have offering lists that are extensive but do not fit into the canonical pattern - *ny-k3-nzwt* I (G2155), *sš3t-ḥtp; hti* (G5150), and *whm-k3i*.² The traces available of the list of *ddf-ḥwfw* (G III S) suggest that it also fitted into this group, but it is too damaged to be of direct assistance.³ One feature common to all these lists is that they were all on the south wall of the offering chapel. Furthermore, the panels of the false doors contained just a few offerings such as the oils and the occasional other element, but no linen list. The following conclusions all assume that the nearer the form of the offering list to the canonical one, the later its date.

This group of lists have much in common with that of *snfrw-snb*, all containing at least seventy elements not in canonical order, but including very many that were to be in the canonical list, and several that were not.⁴ It would appear that the list of *ny-k3-nzwt* I bears the most similarities to the canonical one in its order and selection of offerings. One important feature found for the first time in a private tomb is the noting of the number of portions of very many of the offerings, possibly also true for the list of *ddf-ḥwfw*. On such a basis it is likely that the list of *sš3t-ḥtp* is earlier in date than that of *ny-k3-nzwt*. With the exception of *whm-k3i*, all the officials would seem to be of the highest rank, very frequently 'king's sons' (in fact 'titular princes'). If the canonical list seems to have come into use in the non-royal cemeteries in or after the reign of Sahure, then the most likely date for the tomb of *sš3t-ḥtp* is the end of the fourth dynasty and for *ny-k3-nzwt* I the early fifth.

The offering list of *sšm-nfr* I (G4940) was perhaps one of the first in a private tomb to be based on the canonical form. This has a total of sixty-seven elements, but omits the first fifteen elements of the canon as well as some of the final ones.⁵ It is interesting to note that the list is not partitioned, but that the number of portions of each offering is indicated. These details emphasise that it is an early example, with still a few trappings of older lists.

1 For *idmy* see Smith, *ZAS* 71 (1935), 139-42.

2 Respectively, Junker, *Giza* II, Abb. 21; LD II, 25 (lower), also Junker, *op. cit.*, Abb. 33; Kayser, *Die Mastaba des Uhemka*, fig. after page 23. The offering list of *nzwt-nfr* (G4970; Junker, *Giza* III, Abb. 9b) is substantially similar to that of *sš3t-ḥtp* and it is indeed likely that it was copied (*id.*, *ib.*, 71, 76).

3 *id.*, *Giza* X, Abb. 25.

4 See Barta, *Opferliste*, 51-9.

5 LD II, 28.

Three further tombs provide possible examples of the first use of compartments in the lists of non-royal persons. **k3i-nfr** (G2150) has a list of twenty-four elements in compartments on the east wall of his chapel.¹ This is perhaps some sort of experiment with the new list, which may explain its unusual location and small size. The other examples are those of **k3i-pw-nzwt**; **k3i** (G4651), and **k3i-swd3** (G5340).² These two tombs both have full offering lists on the south wall of their chapels.

It is probable that by the reign of Neferirkare or slightly later the canonical offering list had been established as the standard form in all cemeteries at Giza, appearing later in private tombs than those of the royal family. It thus suggests, as one might expect in ancient Egypt, that new developments were first used by the royal family, and were then a little later emulated by non-royal officials.

C. The Chapels and False Doors of the Early Period at Giza

In comparison with the false doors from Saqqara of the fifth dynasty, the examples found at Giza in the early period are much more simple, with generally less features useful for the purposes of dating. Consequently, the examination of the position of the false door in the chapels and the adjoining schemes of decoration assumes more importance.

Tombs of holders of relevant titles in the early period are found in the following Giza Cemeteries: G7000, G2000, G4000, the Cemetery en Echelon and the Khafre Quarry Cemetery. Of these, only the first and last seem to have been the places of burial of true members of the royal family; the others probably contained the tombs of the most important non-royal officials. Leaving aside for the present the Khafre Cemetery, the tombs of which are almost all rock-cut and probably obey different decorative rules, the chapels in these cemeteries are of two broad types, those with one niche or false door and those with two (examples figure 6). These two chapel types will form the basis of the discussion of the tombs of this period.

1. Chapels with Two False Doors

This chapel type appears first in the early fourth dynasty, reign of Khufu; a typical one of slightly later date is illustrated in figure 6a. An important example is the chapel of the second subsidiary pyramid of that king (G1b), which was undecorated.³ From

1 Reisner, **Giza I**, fig. 260.

2 Respectively, Junker, **Giza III**, Abb. 17; **LD II**, 85a, Junker, **Giza VII**, Abb. 70. **k3i-pw-nzwt** is probably early fifth dynasty since he was responsible for the false door of **nfrt-i3btt** (G4650) of the fourth dynasty, while **k3i-swd3** was probably the son of **k3i-nfr** above.

3 Plan, Reisner, **Giza I**, 211, fig. 20.

Figure 6: Two Principal Chapel Types at Giza in the Fourth Dynasty

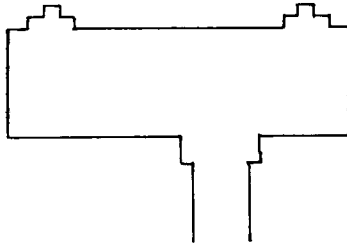

a. Tomb of **sš3t-ḥtp; ḥti** (G5150)
Adapted from Junker, **Giza II**, Abb. 23.

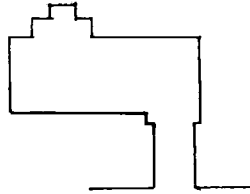

b. Tomb of **ḥ'f-ḥwfw I** (G7140)
Adapted from Reisner, **Giza I**, fig. 114.

an inscription found near to the entrance to the mortuary temple of Khufu it would seem likely that the major constructions of that reign were being erected around the year of the eighth cattle-count, perhaps about the middle of the reign.¹ A further example may be found in the tomb of **'nh-ḥ3f** (G7510), although the southern niche is far larger than the northern. A very elongated example is in the tomb of **ḥm-iwnw** (G4000); another is in the unassigned mastaba G2000.²

These last three mastabas are all the largest in their respective areas of the cemetery. It would be logical for G7510 and G2000 to be the oldest mastabas in each section of the cemetery, although Reisner preferred to see G7510 as later than the others.³ The position would then be that the largest mastabas at Giza were built for the most important people of the reign of Khufu, and that

-
- 1 Smith, **JNES** 11 (1952), 126-7 (1), fig. 7 ('Cheops Temple').
 - 2 For plans of these three tombs see respectively, Reisner, **op. cit.**, fig. 8; Junker, **Giza I**, Abb. 18; Reisner, **op. cit.**, fig. 4.
 - 3 **op. cit.**, 148, 212.

they used in their tombs a special chapel type otherwise used only by one of the king's wives.

The two-niched chapel type was also used by the royal family of Khafre in their rock tombs, presumably in the reign of Menkaure and later. It made its first appearance in the tombs of non-royal individuals towards the end of the dynasty.

Table 4 is a list of the more important private chapels of this type, with very approximate dates, partly based on the above study of the offering lists. In all these examples, the space between the false doors is filled with some sort of offering scene, and usually the deceased is shown before a series of registers of offering bearers, butchers and the like.

Table 4

Chapels of Private Individuals with Two False Doors at Giza

Date/Name	Tomb	Source for False Doors and West Wall
Late Dynasty 4		
mry-ib	G2100-I	LD II, 19.
dw3-n-r'	G5110	Unpublished
End Dynasty 4 - Early 5		
sš3t-ḥtp	G5150	LD II, 23; Junker, Giza II, Abb. 28.
ny-k3-nzwt I	G2155	id., ib., Abb. 18.
k3i-nfr	G2150	Reisner, Giza I, fig. 257.
Sahure and later		
sšm-nfr I	G4940	LD II, 27.
nn-sdr-k3i	G2101	Junker, Giza II, Abb. 9-10.
k3i-pw-nzwt; k3i	G4651	id., Giza III, Abb. 16.
nzwt-nfr	G4970	id., ib., Abb. 27.
pr-sn	LG 20	LD II, 83b.
snnw-k3i; kki	G2041	One part, Smith, Sculpture, pl. 45b.
k3i-swd3	G5340	Junker, Giza VII, Abb. 69.
Neweserre and later		
sšm-nfr II	G5080	Unpublished
nfr-b3w-pth	G6010	LD II, 58b.
nfr	G4761	Junker, Giza VI, Abb. 6-12.
Djedkare		
sšm-nfr III	G5170	Brunner-Traut, Die altägyptische Grabkammer Seschemnofers III aus Giza, Beil. 3.

The decoration of the jambs of the false doors, of which there are usually only one pair, consists either of a figure of the deceased with texts above, or one or two registers of depictions of family or dependents. In the tomb of **sš3t-htp**, copied in that of **nzwt-nfr**, there is an additional figure of the deceased at the rear of the central niche.

The lintel and architrave usually contain simple decoration, with only one or two lines of text. The text on the architraves of **sš3t-htp** and **k3i-nfr** is laid out in the form of short vertical columns; this is perhaps a stylistic feature of the early fifth dynasty. The first figures of the deceased on architraves are in the tombs of **nn-sdr-k3i** (daughter of **mry-ib**) and **k3i-swd3** (son of **k3i-nfr**), and are thus not among the earliest examples.

The space between the false doors is decorated in a variety of different ways. There are three basic types, examples of which are as follows: **mry-ib** stands to the left of the northern false door facing left (scheme one), while **sšm-nfr I** is to be found at the right of the southern door facing right (scheme two), and then **nfr-b3w-ptḥ** is seated at the right of the southern door facing right (scheme three).¹ These are illustrated in figures 7-9.

Schemes one and two are effectively reversals of one another, although the first exhibits the more complex decoration, perhaps as the owners were of higher rank. Between the staff of the deceased in these examples and the other false door are several registers, depicting a selection of scenes including offering bearers, children, butchers and personified estates. That the degree of complexity may in some way be related to rank, and consequently royal favour and financial resources, is illustrated by the wall of the lowest-ranking official in either of the first two groups, **k3i-pw-nzwt**, which also possesses the least decoration.

The difference between these two and scheme three is more marked. There is no series of registers, but rather the deceased is seated at an offering table in the conventional position for such activity. This scene may be accompanied by a depiction of priests or dependents performing funerary rites (**nfr-b3w-ptḥ**) and there may be an additional register with butchers (**sšm-nfr III**). There is almost always an offering list above the table scene, apparently transferred there from the previous location on the south wall.

If we correlate these three types with the list given above of chapels with two false doors, a definite pattern by date emerges (Table 5).² Some examples do not fit exactly into this pattern. The position of **nzwt-nfr** is to be explained by the copying of his scenes from the earlier mastaba of **sš3t-htp**. The surviving details

- 1 Scheme three in fact has its origin in a royal tomb of the fourth dynasty, that of **ny-k3w-r'** (LD Erg., Taf. XXXV (upper)). This is further evidence that such developments frequently manifested themselves in the tombs of royalty some time before being adopted by private individuals.
- 2 Omitted from this table are **nn-sdr-k3i**, whose western wall has no decoration apart from the false doors, and **k3i-swd3**, where the decoration consists of a large palace-facade design.

Figure 7: West Wall of the Tomb of mry-ib (G2100-I-annexe)



LD II, 19

Figure 8: West Wall of the Tomb of s̄m-nfr I (G4940)

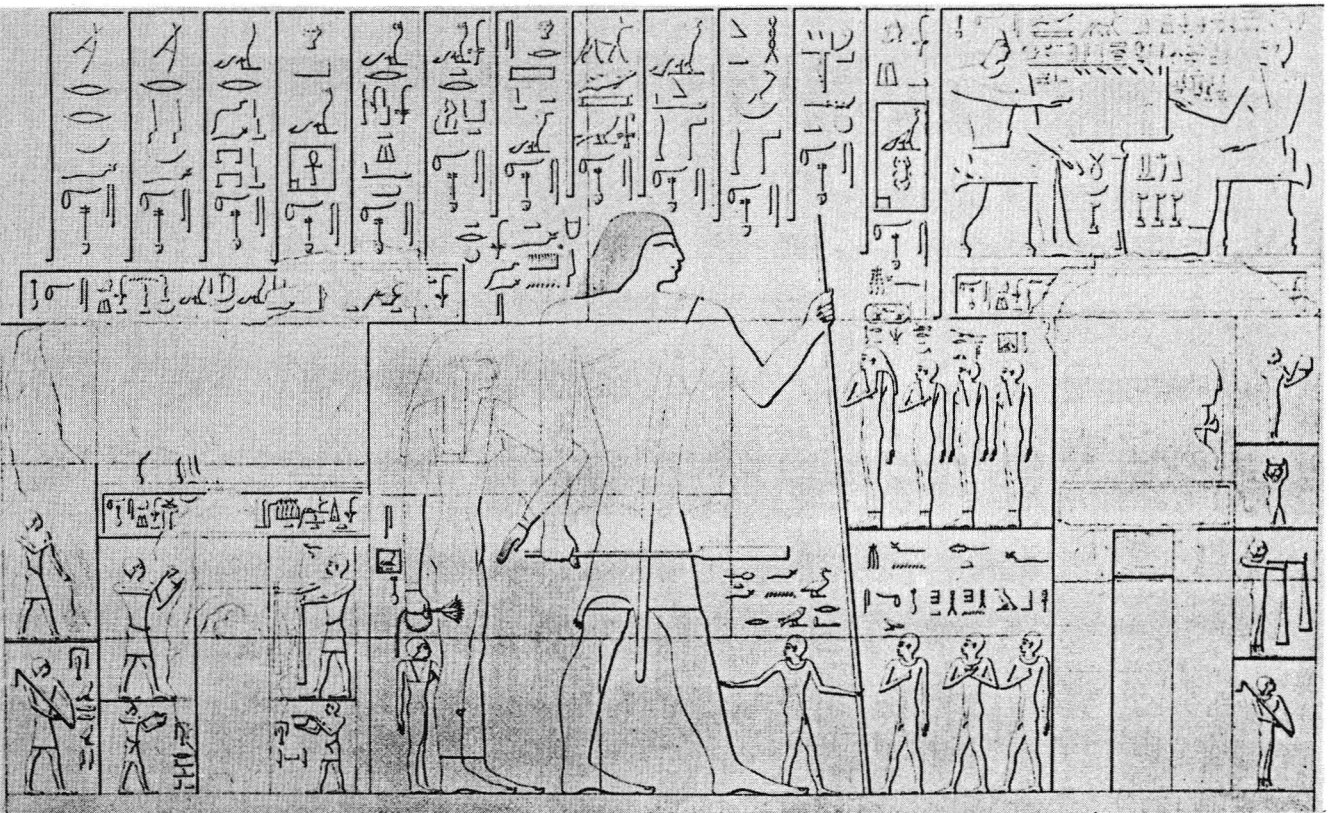

LD II, 27

Figure 9: West Wall of the Tomb of nfr-b3w-ptḥ (G6010)

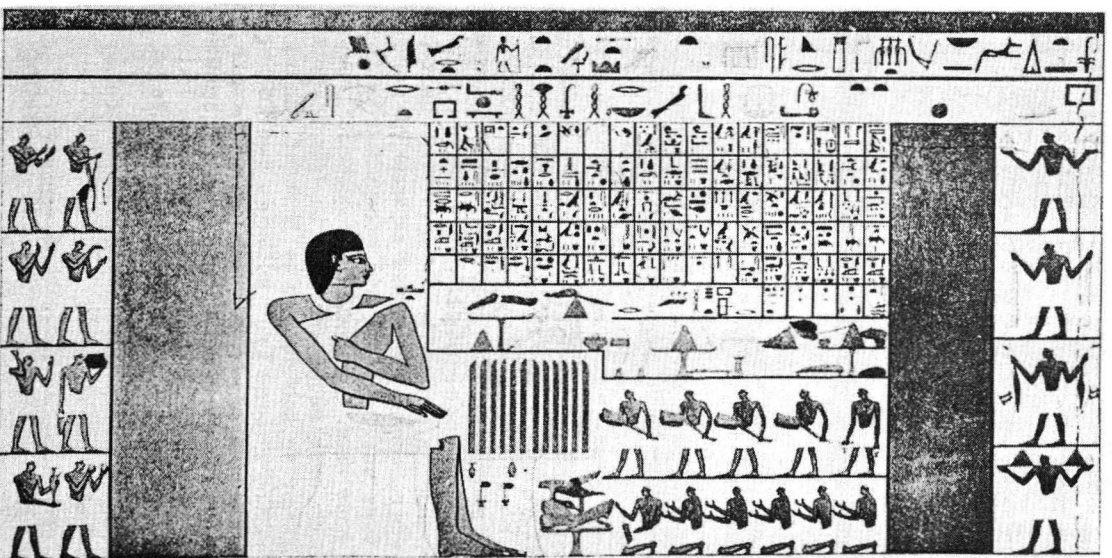

LD II, 58b.

Table 5

Schemes of West Wall Decoration of Officials in Table 4

Name	Scheme 1	Scheme 2	Scheme 3
mry-ib	X		
dw3-n-r'		X	
sš3t-ḥtp	X		
ny-k3-nzwt I	X		
k3i-nfr	X		
sšm-nfr I		X	
k3i-pw-nzwt; k3i		X	
nzwt-nfr	X		
pr-sn		X	
snnw-k3i; kki			X
sšm-nfr II			X
nfr-b3w-ptḥ			X
nfr			X
sšm-nfr III			X

of the west wall of the tomb of **dw3-n-r'** are suggestive of scheme two in a period before its more frequent use. A possible explanation of this apparent inconsistency is that, as vizier and one of the most important people in the land, he would have perhaps been in a position to use new developments in a manner akin to that of the royal family.¹ One objection to this is that **sš3t-ḥtp**, who was vizier a little later, shows the older scheme of decoration, but this tomb was in fact built before his promotion to the vizierate, when he would not have been granted the same privileges.

Scheme one, which originated perhaps in the reign of Menkaure, seems to have given way to scheme two by that of Sahure or a little later (**sšm-nfr I**). The change from schemes two to three can only be dated using the tombs of **sšm-nfr II** and **nfr-b3w-ptḥ**, both probably of the reign of Neweserre.² This last arrangement was the most enduring. A development of it was to use a false door with two, as opposed to one, pairs of jambs, one example of which probably dates to the sixth dynasty.³

- 1 **dw3-n-r'** was depicted standing on the south wall, a practice seemingly never used again.
- 2 For **sšm-nfr II** see the Prosopography; the dating of **nfr-b3w-ptḥ** derives from his relationship to **iy-mry** (G6020) and **'nh-špss-k3f** (G6040). For the dating of this family see Baer, **Rank and Title**, 54 (21), 91 (258), 135 (491), 287 (21), 291 (258), 293-4 (491).
- 3 **k3-ḥif**, Junker, **Giza VI**, Abb. 31-7.

2. 'L'-shaped Chapels with One False Door

An example of this chapel type is shown in figure 6b. Those of most relevance to the subject of this work belonged to the children of Khufu buried in the Eastern Cemetery, and there is also the chapel of **nfr** (G2110) (see table 6).

These chapels all follow a similar plan except those of **nfr-m3't**, **h'f-snfrw** and **nfr**. The false door is to be found near the southern end of the west wall, with the principal decoration to the north of it. The deceased is at the extreme right of this area, in most cases with his wife, watching several registers of offering bearers, personified estates and butchers, with his titles above his head. Those of **nfr-m3't** and **h'f-snfrw** comprise a central palace-facade false door, with representations of the deceased and his wife either side. That of **nfr** has the false door at the north end with the deceased and wife seated at the south. All the false doors (where preserved) have only one pair of jambs.

The orientation of the scenes on the western wall in general follows that previously termed scheme one, making it clear that this was the original pattern adopted for the decoration of private tombs from the early to later fourth dynasty.

The unusual arrangement of the chapel of **nfr** is difficult to explain, but may to some extent be due to its being perhaps the earliest decorated chapel of a private individual who was not a vizier, and thus something of an experiment. All these examples antedate most of those with two false doors, suggesting that the former was superseded by the latter as the type used by the highest officials.

Table 6

Principal Chapels with one False Door at Giza

Name	Tomb	Source for False Door and West Wall
k3i-w'b	G7120	Simpson, Giza Mastabas III , fig. 14-5.
nfr-m3't	G7060	LD II, 17a.
ddf-hr	G7220	Unpublished
h'f-hwfw	G7140	Simpson, op. cit. , fig. 32-3.
dw3-n-hr	G7550	LD II, 82a; cf. Reisner, Giza I , 328 (4) for description of unpublished part.
k3i-m-shm	G7660	LD II, 32 (left); cf. Reisner, op. cit. , 328 (2) for description of unpublished part.
ddf-minw	G7760	LD II, 33b.
h'f-snfrw	G7070	LD II, 16 (lower).
d3ty	G7810	Unpublished
nfr	G2110	Reisner, op. cit. , fig. 241.

3. Rock-cut Tombs

The number of rock-cut tombs which belong to officials relevant to this work is small, comprising principally many of the members of the families of Khafre and Menkaure, but also some later officials. A summary of Giza rock-cut tombs is given by Reisner.¹ The plan of these tombs of the royal family is very different from the mastabas described above. However, the use of a pair of false doors is quite common, and the offering lists of these tombs are very much part of the pattern of development of the canonical offering list described above (page 39), while the western wall of the tomb of **ny-k3w-r'** shows the beginning of the type of decoration previously termed scheme three. The use of the false doors in these tombs for the purposes of dating is minimal, as they are rarely, if ever, decorated. The major decorated examples seem to be those of **mrs-'nh** III;² the extent of the decoration in this rock tomb is more in keeping with that of the western and eastern cemeteries than that in the Khafre Cemetery.

Later rock-cut tombs of relevant officials are consistent neither in plan nor false door type. It would seem that the type of door is the same as that used in mastabas and exhibits no special forms in rock-cut tombs.

D. False Door and Chapel Types at Giza which originated at Saqqara

The principal import to be discussed here is the false door with cornice and torus moulding, which came into use in the middle of the fifth dynasty at Saqqara with the highest officials and became the commonest type by the beginning of the sixth.

Several relevant officials from Giza had false doors of this type. The earliest well-dated example is that of **sndm-ib; inti** (G2370),³ dated by his biography to the end of the reign of Djedkare. This was followed by those of his sons **sndm-ib; mhi** (G2378)⁴ and **hnmw-nti** (G2374 - unpublished). It is logical to assume that, although these men were not buried in the principal necropolis of that time, the fact that they were viziers meant that they would have the means or status to use the stylistic features employed by comparable men buried at Saqqara. Their tombs are also the first well-dated examples of the use of the east-west offering room at Giza, a form very much associated with this type of false door, and also the complex chapel.⁵

Examination of the other examples of torus and cornice false doors show them to be generally similar to those from Saqqara. A good example of this is the door of the vizier **idw I; nfr**

1 Giza I, 219-47.

2 Dunham-Simpson, **Giza Mastabas I**, figs. 7, 10.

3 Mariette, **Mastabas**, 505-7; further evidence from excavation records in Boston.

4 LD II, 75.

5 Plans, Reisner, **Giza I**, figs. 162, 164, 165.

(G5550),¹ which resembles the door of **mḥw** from Saqqara. The Giza doors of this type belonging to officials below the rank of vizier tend to be less complex than those at Saqqara; for example many have only one column of text per jamb, where two or more is normal at Saqqara. The doors of **q3r** and **ny-s'nh-3ḥt** exemplify this point.²

The Saqqara development of the so-called 'T'-shaped panel is also attested at Giza, probably late in the sixth dynasty (above page 18), although it is not found in the tombs of men studied in this work.³ The immediate precursor of the torus and cornice false door seen at Saqqara, typified by wide jambs, large figures of the deceased and wide panel apertures, is found only once at Giza, that of **'nh-ḥwfw**.⁴ It is evident from the texts that this piece was presented to **'nh-ḥwfw** by the king (not named), and the fact of this special origin may explain the use of a form not native to Giza, as the king is very likely to have commanded the production of a door according to the most fashionable type then in use, the principal number of which were being made for tombs at Saqqara.

E. Other Types

The remaining type to be discussed will be termed the 'Giza Door', so named because it is peculiar to this site, where it is extremely common. Its characteristics are the use of two pairs of jambs, which most frequently bear single vertical columns of incised inscription, a wide architrave and a simple panel scheme.⁵

This door type seems to have evolved at some time after the development of scheme three of wall decoration outlined above since tombs are found with the same wall arrangement but which employ a pair of these new doors in place of the old ones with single jambs.⁶ It is possible that this false door type developed about the middle of the fifth dynasty at the earliest. Some of the relevant officials possess similar doors, such as **'nh-ḥ3f**; **q3r**, but their further development is almost impossible to sequence because of the difficulty of finding independent dates for many of the tombs in which they occur.

1 Junker, **Giza VIII**, Abb. 34.

2 Respectively, Simpson, **Giza Mastabas II**, fig. 32; Hassan, **Giza III**, fig. 109.

3 A typical example of this panel shape is on the door of **ḥnni** (Junker, **Giza XI**, Abb. 40).

4 Boston MFA 21.3081; Reisner, **Giza I**, pl. 65b, dated no earlier than the reign of Weserkaf by the presence of a sealing of that king in the burial chamber, *id.*, *ib.* II, 52, fig. 54 (G4520a).

5 Typical examples are those of **ḥwy** (Junker, **Giza IX**, Abb. 11), **ḥnw** (Hassan, **Giza II**, fig. 193) and **ḥnmw-df3i** (*id.*, *ib.*, fig. 48).

6 For example, the doors and west walls of **irrw** (Hassan, **Giza III**, fig. 56-8) and **sm3-'nh** (*id.*, **Giza VI**³, fig. 161).

F. Conclusions

Down to the later fifth dynasty, the development of the false door at Giza was separate from that evident at Saqqara, the other major Old Kingdom memphite necropolis. The site of Giza is most important for the original development of the offering panel and associated inscriptions into a form that may be recognised as the Old Kingdom false door; this happened in the fourth and early fifth dynasties, after which time major developments took place at Saqqara. This pattern may be correlated with the changes in the place of burial of the most important officials of the state. After the importance of Giza had declined as a result of the highest officials transferring their place of burial to Saqqara, false doors at Giza remained very much in the old style with one or two modifications until the further burial of important men caused the introduction of false door types found otherwise only at Saqqara. Acceptance of these doors by officials not of the highest rank at Giza took much longer than at Saqqara, and they only begin to appear in any number in the later sixth dynasty. This is due to the strength and persistence of the older type of false door. Other types of door are found at Giza in addition to those enumerated above, but their discussion has had to be curtailed due to a lack of relevance to the officials whose titles form the subject of this work.

PART II

Prosopography

This section attempts to collect and date all officials who held the titles *imy-r ḥwt wrt*, *imy-r ḥwt wrt 6*, *imy-r zš 'nzw*, *imy-r k3t (nbt) (nt) (nzw)*, *imy-r šnwt*, *imy-r šnwty*, *imy-r pr-ḥd*, *imy-r prwy-ḥd*, *t3yty z3b t3ty* and associated forms from the beginning of the fourth dynasty to the end of the Old Kingdom. A few clear First Intermediate Period examples are included to be able to compare them with the officials who lived in earlier times.

The entry for each official is laid out in the same manner. His name is given, and a reference number is assigned to him which will be used in this part and the discussions of titles to follow; it is always placed after his name thus: *3ḥt-ḥtp* (2). Any other names by which the official is known or which will be used in this work are also given. Notes on sources and bibliography follow. Wherever possible, the entries in Porter and Moss, **Topographical Bibliography (PM)**, are used, principally to avoid the need for a cumbersome number of references. The official's titles are listed, split into 'Relevant Titles', those discussed in the later chapters, and 'Other Titles', for the purposes of reference. A short account of the dating of the official in question is given next, to justify his approximate position in the lists at the beginning of the later chapters. Other discussions of dating are only referred to where they are useful; in the case of references to Baer, **Rank and Title**, only the principal occurrence is given, and the reader is requested to consult Baer's List of Dated Tombs (pp. 286-95) under the given number. The entry ends with a summary of the suggested date.

References in this Prosopography to chapter 2 on criteria concerned with false door and tomb design are necessarily many, and we will refer to the various sections by their numbers: 'Chapter 2.I.E.1' means 'Chapter 2, section I, subsection E, part 1'. These section numbers are incorporated into the page headings.

3hi 1

- Source: Mastaba in the Western Cemetery at Giza, G4750.
 Bibliography: PM 3², 137.
 Relevant Titles: imy-r prwy-ḥd, imy-r šnwwt nzwt, imy-r k3t nbt nzwt.
 Other Titles: imy-r zš 'prw, [imy]-r /// t_{nw}, wr md šm'w, [r]ḥ nzwt, ḥry-sšt3, ḥrp wsht, ḥrp nsty, z3b 'd-mr.

This mastaba has survived in very poor condition, inscriptional and representational material being in the form of fragments. The chapel is of the exterior type with an L-shaped plan and the false door at the southern end. No indications of the orientation and arrangement of this false door and the wall scenes may be gained. A similar example of an exterior chapel is that of nfr (84); that of 3hi has the false door in a more conventional position (at the south rather than north end of west wall), and may be consequently later in date. Parallels may be found for the architrave inscription¹ in the tombs of sš3t-ḥtp and k3i-nfr at Giza (above page 44), both of which are presumably to be dated to the beginning of the fifth dynasty.

Suggested Date: End of the fourth dynasty or slightly later.

3ht-ḥtp 2

Son of pth-ḥtp I (49)

- Source: Tomb to the west of the Step Pyramid at Saqqara, D 64.
 Bibliography: PM 3², 599-600.
 Relevant Titles: imy-r prwy-ḥd, imy-r zš 'nzwt, imy-r šnwty, t3yty z3b t3ty.
 Other Titles: iwn knmwt, imy-r wsht, imy-r wd'-mdw nb, imy-r niwt mn-swt-ny-wsr-r', imy-r niwt nfr-dd-k3-r', imy-r niwt ntr-swt-mn-k3w-ḥr, imy-r šm'w, imy-r gs-pr, wr md šm'w, mdw rhyt, nst ḥntt, ḥm-ntr m3't, ḥrp wsht, ḥrp zš, ḥrp zš ḥry sprw ?, ḥrp zš nb, ḥry-tp nzwt, z3b 'd-mr, smr w'ty, šhd ḥm-ntr mn-swt-ny-wsr-r', šhd ḥm-ntr nfr-dd-k3-r', šhd ḥm-ntr ntr-swt-mn-k3w-ḥr, /// nbt nt nzwt.

For the family relationships and general time-position, see the discussion below of pth-ḥtp I (49). Baer dates the tomb of 3ht-ḥtp to his period VD, the succeeding one to that of his father.² The appearance of the šhd zwnw wnn-nfr in the tombs of both pth-ḥtp I

1 Junker, Giza I, Abb. 57 (1).

2 Later reign of Wenis to early reign of Teti, Rank and Title, 53 (13).

and **3ht-htp**¹ does not imply that they worked together as Helck assumes,² but it does suggest that the difference in time between their periods of office may have been less than a generation of twenty-five years or so. On such a basis, **3ht-htp** may be dated to the early reign of Wenis.

Suggested Date: Early reign of Wenis.

3ht-htp; hmi 3

Source: Tomb north of the causeway of the pyramid of Wenis at Saqqara, usurped at a later date by **nb-k3w-hr; idw** (82).

Bibliography: **PM** 32, 627-629; for the separation of the titles of **3ht-htp** and **nb-k3w-hr**, see Strudwick, **GM** 56 (1982), 89-94.

Relevant Titles: **imy-r prwy-hd, imy-r zš ' nzw, imy-r šnwt, t3yty z3b t3ty.**

Other Titles: **im3-¹, imy-iz nhn, imy-r w'bt, imy-r prwy-nwb, imy-r swt špswt pr-'3, imy-r šwy pr-'3, imy-r gs-pr, iry p't, iry nfr-h3t, 'd-mr dw3-hr-hnty-pt, mniw nhn, h3ty-', hry-sšt3, hry-sšt3 n pr-dw3t, hry-tp nhb, hry-hb, hry-hb hry-tp, zš md3t ntr, smr w'ty, smr w'ty n mrwt, šhd hm-ntr nfr-swt-wnis, sd3wty bity.**

The tomb of **3ht-htp; hmi** is one of five tombs of viziers in the Wenis cemetery, the others being those of **ihy** (15), **iy-nfrt; š3nf** (6), **ny-'nh-b3** (70) and **mhw** (69). We will explore the hypothesis that they may all, with the exception of **mhw**, in whose tomb Pepy I is mentioned, have been viziers of Wenis buried around the pyramid of their king.

A type of tomb is found in the Wenis cemetery which does not have exact parallels elsewhere, notably in its use of what are probably storerooms and a large pillared court of a type different from that used in the tombs of the reign of Teti. Examples are the mastabas of **3ht-htp** and **ny-'nh-b3**, as well as those of the queens **nbt** and **hnwt**.³ The general pattern of the chambers in the tomb of **ihy**, which lacks the court and storerooms, is quite similar. **nbt** and **hnwt** were almost certainly wives of Wenis, and one would consequently expect the construction of their tombs to have begun in his reign. On the similarity of tomb plans, the viziers may also be of the same date.

The disposition of the tombs would also seem to support this theory. With the exception of the very small later mastabas on the site, the two queens' tombs are the closest to the mortuary temple, and the large tombs of the officials are in two locations: one row,

1 Murray, **Saqqara Mastabas I**, pl. XI; Davies, **Ptahhetep and Akhetetep II**, pl. XVIII.
 2 **Beamtentitel**, 138.
 3 Bieger-Munro-Brinks, **SAK** 1 (1974), 35-54, Abb. 1.

including iy-nf_{rt}, ihy and also the imy-r šm'w 'nh-wnis,¹ is between these queens' tombs and the temenos wall of the Step Pyramid, while those of 3ht-htp and ny-'nh-b3 are situated next to each other at the upper end of the causeway of the pyramid. It would seem possible that the tombs in each group could have been constructed simultaneously.

Only the tombs of 3ht-htp and ihy lend their title sequences to a date. Baer dates ihy to his period VIC (mid-sixth dynasty, see below); this is probably incorrect, but his date for 3ht-htp suggests that the tomb was built in the early to middle part of the reign of Wenis.² The similarity of the mastaba of ny-'nh-b3 suggests that its date too may be akin to that of 3ht-htp. ihy and iy-nf_{rt} are less easy to date more closely. Their mastabas are separated from each other's by that of 'nh-wnis; if this name was given to him (or changed from another) after the accession of Wenis, his tomb is unlikely to have been constructed before the later part of that reign, perhaps together with the two neighbouring viziers' tombs.

Suggested Date: Middle of the reign of Wenis.

3ht-htp 4

Source: Tomb to the north of the causeway of the pyramid of Wenis at Saqqara, about 150 metres south-east of the entrance to the Step Pyramid complex, E 17.

Bibliography: PM 3², 633-4.

Relevant Titles: imy-r hwt wrt.

Other Titles: iwn kmwt, imy-r wpt, imy-r wpt htpw ntr m prwy, mdw rhyt, nst hntt, hm-ntr m3't, hm-ntr nfr-swt-wnis, hm-ntr nfr-dd-k3-r', hm-ntr hwt_{hr} nbt iwnt, hm-ntr hqt, hry-sš3 n wd'-mdw nb n hwt wrt, hrp wsht, hrp zš, hrp zš iry sprw, hry-tp nzwt, z3b 'd-mr, z3b šhd zš, zš n z3.

Two dates have been assigned to this tomb, the reign of Wenis or shortly afterwards, based on the presence of the name of that king's pyramid in his titles, and the later sixth dynasty.³

The false doors from this tomb are of the type with cornice and torus moulding. The standing figure of the deceased on the upper lintel of the inner door may be compared to the example of k3i-pw-r' (143), in whose tomb Djedkare is mentioned, although sixth dynasty examples are sometimes found (Chapter 2.I.E.1). The chapel is of a squarish shape, and could thus be an early example of the east-west type, possibly built before the general standardisation of the form. These indications are very vague, but coupled with the location of the tomb seem to prefer the earlier of the two

1 PM 3², 616-7.

2 Period VC, later reign of Djedkare to middle Wenis; Rank and Title, 53 (14a).

3 Baer, op. cit., 53 (14).

dates noted above.

Suggested Date: End of the fifth dynasty to early sixth.

iy 5

Source: Tomb at North Saqqara, south of the pyramid of Teti, east of that of Weserkaf, C 26 (LS 20).
 Bibliography: PM 3², 565.
 Relevant Titles: **imy-r k3t nbt nt nzwt.**
 Other Titles: **imy-r mš', hry-sšt3 n h3swt nbt, shd imw, sd3wty ntr m imwwy.**

The tomb of iy is the only one of the Old Kingdom found so far in this area of Saqqara, the others being of Late Period date. However, it is not improbable that when built it was considered as part of the main North Saqqara cemetery, located away from the main area, as is the tomb of **k3i-m-snw** (144), assuming this latter to antedate the pyramid of Teti (see further below).

This mastaba seems to be formed of a small east-west offering chapel, entered from a corridor. The false door is the only decoration. The plan of the chapel suggests the middle of the fifth dynasty at the earliest (Chapter 2.I.H). The closest parallels to the false door are found in the small cemetery mid-way on the Wenis causeway, for example those of **hnmw-htp**, **nfr** and **k3h3i** and **3ht-htp**.¹ In all probability these cannot be later than the reign of Djedkare, because of their position in relation to the Wenis Causeway, and the likelihood is of a similar date for iy.

Suggested Date: Mid to later fifth dynasty, perhaps about the reign of Djedkare.

iy-nfrt; š3nf 6

Source: Tomb in the Wenis pyramid cemetery at Saqqara, south of the temenos wall of the Step Pyramid.
 Bibliography: PM 3², 616; very largely unpublished - personal examination of tomb.
 Relevant Titles: **imy-r prwy-hd, imy-r zš ' nzwt, t3yty z3b t3ty.**
 Other Titles: **imy-iz, imy-iz nhn, imy-r h3swt, mniw nhn, h3ty-', hry-sšt3, hry-sšt3 n pr-dw3t, hry-hb, hry-tp nzwt, z3b 'd-mr, smr w'ty, smr w'ty n mrwt.**

The relative and absolute datings of this cemetery have been discussed above in the entry for **3ht-htp; hmi** (3). Confirmation of the approximate date suggested there would seem to be forthcoming

1 Respectively, Moussa-Altenmüller, **Nianchchnum**, Abb. 26; **id.**, **The Tomb of Nefer and Ka-hay**, pl. 28-30; Zayed, **ASAE** 55 (1958), 128-32, pl. II-V.

from the preliminary report on the site by Hblscher and Munro.¹

Suggested Date: Middle to late reign of Wenis.

iwn-minw 7

Source: Rock-cut tomb in the Central Field at Giza, in the cliff south-east of the pyramid of Khafre, LG 92.

Bibliography: PM 32, 237.

Relevant Titles: **t3yty z3b t3ty.**

Other Titles: **/// n iti.f, iry p't, wr 5 pr-dhwty, [hry-s3t3] pr-[dw3t] ?, hry-s3t3 [n iti.f], hrp 'h, hry-hb n iti.f, hry-hb hry-tp, z3 nzwt, z3 nzwt n ht.f smsw, zš md3t ntr, smr w'ty, smr w'ty n iti.f, sd3wty bity.**

The parents of **iwn-minw** are not explicitly mentioned in his tomb, but it may be inferred from his titles with **n iti.f** that his father was a king, probably Khafre by analogy with the other king's sons, such as **ny-k3w-r'** (78) and **sh̄m-k3-r'** (125), buried in the area.

Of all the sons of Khafre buried in this cemetery, only in the case of **sh̄m-k3-r'** are some details given of when he may have died, probably in the reign of Sahure. He would thus have been a minimum of thirty-five and a maximum of seventy years of age at death. He could have been the last surviving son of this king, particularly since the purpose of his inscriptions was surely to stress his longevity.

In the biography of **dbhn**, the deceased makes plain the beneficence of Menkaure in granting him a tomb,² a special privilege in view of the fact that this cemetery was otherwise used only for the burials of true king's sons - **dbhn** does not seem to have been of royal descent. Such a deduction implies that these other men had already begun to cut their tombs, very likely in view of the probable date in the tomb of **ny-k3w-r'** (78). The king's sons in this area may thus have held their highest offices between the reigns of Menkaure and Sahure. It is also likely that the more senior sons were buried in tombs prominently located in the cliff face, while the junior ones were buried in the area in front of this cliff.

Suggested Date: Perhaps end of the fourth dynasty.

iwn-r' 8

Son of Khafre

Source: Rock-cut tomb in the Central Field at Giza, south of the western end of the causeway of the pyramid

1 SAK 3 (1977), 121.

2 Urk. I, 18-21.

of Khafre.
 Bibliography: PM 32, 243.
 Relevant Titles: imy-r k3t nbt.
 Other Titles: iry p't, wr ht, h3ty-', hm b3w nhn, hry-sšt3 n
 iti.f, hry-sšt3 n pr-dw3t, hrp 'h, hry-hb hry-tp n
 iti.f, z3 nzwt n ht.f smsw, zš md3t ntr n iti.f,
 smr w'ty n iti.f.

The entrance drum of this tomb states that the owner was an eldest son of Khafre, without mentioning his mother. For other features that may help to determine the date, see under iwn-minw (7) above. The position of his tomb in the area in front of the cliff and the lack of the title t3yty z3b t3ty held by many other sons of Khafre may suggest that he was a younger son of that king, who attained office-bearing age at the time when the royal family was gradually being removed from the administration.

Suggested Date: Early fifth dynasty.

ipi-hr-ssnbf 9

Source: False door and coffin (latter from shaft Hmk 69), possibly belonging to the same man, found in the Teti pyramid cemetery at Saqqara.
 Bibliography: False Door: PM 32, 544; coffin: PM 32, 538.
 Relevant Titles: imy-r šnwt.
 Other Titles: /// m swt št3t, imy-r mš', mty n z3 dd-swt-tti, rh
 nzwt m3', hnty-š ///, hrp 'prw n nfrw.

The shaft in which this coffin was found is one of many dating to the period later than the major monuments in the cemetery. The appearance of coffin texts suggests a date in the late Old Kingdom at the earliest. Nearby are tombs mentioning Merykare of the tenth dynasty, suggesting the First Intermediate Period as a strong possibility.

Suggested Date: Late Old Kingdom to First Intermediate Period.

iffi; ffi 10

Source: Tomb at North Saqqara, no. 2 (B 10).
 Bibliography: PM 32, 449.
 Relevant Titles: imy-r šnwt, imy-r šnwt nzwt.
 Other Titles: imy-r hmwt, imy-r hmwt n hkr nzwt, w'b w'b-swt-
 wsr-k3f, hm-ntr pth, hm-ntr r' m nhn-r', hm-ntr
 zkr.

The inscriptional material from this tomb is restricted to an unfinished false door and a limestone offering basin. Baer suggests the fifth dynasty or later, arrived at on the basis of the position in the cemetery (far north-west) and the cruciform

chapel.¹ This latter feature is indeed perhaps that of most use; as discussed above (Chapter 2.I.H), it has its roots in the early fourth dynasty, but would not seem to extend very far into the fifth. The quality of the relief of the false door is described as 'épais, les formes lourdes et trapues',² which is perhaps to be compared to the high relief found in the tombs of the later fourth dynasty at Saqqara, for example that of *mry* (58).

The titles of *iffi* make the reign of Weserkaf the earliest possible date, and it is suggested that the tomb itself was not built long after that reign.

Suggested Date: Early fifth dynasty, shortly after the reign of Weserkaf.

imbi 11

Source: A lintel found in the area of the tomb of *isti*; *tti* near the western enclosure wall of the Step Pyramid complex at Saqqara.

Bibliography: PM 3², 610.

Relevant Titles: *imy-r šnwt*.

Other Titles: *iry d3w* ?, *mty n z3*, *hrp zš*, *hry-tp nzwt*, *hry-tp šnwt*, *šhd zš*.

This lintel is decorated with a line of figures of the owner and (probably) his wife separated by vertical columns of text. This feature is most common in the early to middle sixth dynasty. Other tombs in the same area belong to officials of the reigns of Pepy I and II,³ suggesting the middle sixth dynasty as a possible date.

Suggested Date: Middle sixth dynasty, or possibly later.

irw-k3-ptb 12

Source: Group of offering stands, offering tables and statues in Berlin and Brooklyn, exact provenance unknown, but possibly from Saqqara.

Bibliography: PM 3², 691-2.

Relevant Titles: *imy-r šnwt*.

Other Titles: *imy-r zš šnwt*, *hm-ntr r'*, *hry-tp šnwt*, *zš ' nzwt šnwt*, *zš hryt-' nzwt*, *zš hryt-' nzwt n šnwt*, *šhd zš*.

The paucity of information about this man and the nature of the material make his dating difficult. Porter and Moss assign these monuments to the late fifth dynasty. The offering tables (Berlin

1 Rank and Title, 56 (35b).

2 Mariette, *Mastabas*, 100.

3 Such as *isti* (PM 3², 609-10) and *sbk-m-hnt* (PM 3², 610-11).

1139, 1201) are not discussed by Mostafa, but are of her type (A+B)².¹ This type belongs mainly to the second half of the fifth dynasty, being rather rare in the sixth.²

Suggested Date: Perhaps late fifth dynasty (?).

irw-k3-ptḥ 13

Source: Mentioned in an unclear context in the Abusir Papyri.
 Bibliography: Papyrus Berlin 15728; text, **HPBM**, pl. CIV (A); cf. Posener-Kriéger, **ArchAb** I, 49 n.3, II, 591.
 Relevant Titles: **imy-r zš ' nzwṯ**.
 Other Titles: **z3b 'd-mr**.

The date of most of the documents forming the Abusir Papyri is very vague; a large group of them probably belong to the reigns of of Djedkare or Wenis.³ Posener-Kriéger would group this particular document, on palaeographical grounds, with others that are perhaps of the reign of Djedkare.⁴

Suggested Date: Perhaps late fifth dynasty.

iḥy 14

Source: Tomb in the Western Cemetery at Giza, close to the enclosure wall of the pyramid of Khufu, G5330 (LG 41).
 Bibliography: **PM** 32, 159.
 Relevant Titles: **imy-r ḥwt wrt**.
 Other Titles: **iwn knmwt, imy-r wpt, imy-r wpt m t3 r dr.f, imy-r gs-pr m prwy, mdw rḥyt, ḥry-tp nzwṯ**.

It would seem that this mastaba has a north-south corridor leading to an east-west offering chamber where the false door is to be found. This latter is of the cornice and torus moulding type, with a wide panel filled with offerings and thus leaving very narrow apertures. This last feature tends to be typical of the sixth dynasty (Chapter 2.I.A).

Baer has placed this tomb in his periods VIB, D-F, which, although wide, does not contradict the dating criteria exhibited by the false door.⁵

Suggested Date: Early to middle sixth dynasty (or later ?).

-
- 1 **Opfertafel**, 102-3.
 - 2 **id., ib.**, 120.
 - 3 **HPBM**, xvi.
 - 4 **op. cit.** II, 490-1.
 - 5 **Rank and Title**, 59 (56).

iḥy 15

- Source: Mastaba in the Wenis cemetery at Saqqara, south of the temenos wall of the Step Pyramid, usurped at a later date by *idwt*; *zšzšt*.
- Bibliography: *PM* 3², 617-9.
- Relevant Titles: *imy-r prwy-hd*, *imy-r zš ' nzwt*, *imy-r šnwty*, *imy-r k3t nbt nt nzwt*, *t3yty z3b t3ty*.
- Other Titles: *iwn knmwt*, [*imy*]-*r* /// *t3-mḥw šm'w*, *imy-r gs-pr*, *iry p't*, *mdw rhyt*, *h3ty-'*, *hry-tp nzwt*, *smr w'ty*.

The above titles of *iḥy* come from his sarcophagus, and there is little or no evidence of his name in the chapel proper as usurped. The dating of the major mastabas in this cemetery, with the exception of *mḥw* (69), to the reign of Wenis is discussed generally above under *3ḥt-ḥtp*; *ḥmi* (3).

According to Baer, the title sequences fit into period VIC, Merenre to early Pepy II.¹ However, Kanawati believes that they fit almost as well into period VD,² which agrees better with the date suggested in the above discussion.³

Suggested Date: Late reign of Wenis.

iḥy-ḥnt 16

- Source: Depicted among the officials represented in the mortuary temple of Pepy II at South Saqqara.
- Bibliography: Jéquier, *Pepi II II*, pl. 54 and 57.
- Relevant Titles: *t3yty z3b t3ty*.
- Other Titles: *iry p't*, *h3ty-'*, *hry-hb hry-tp*.

iḥy-ḥnt is not the only vizier to be represented in the original decoration of the mortuary temple of Pepy II: two others are named, *idi* and *ḥnw*, and there is one nameless depiction of a man with the title *t3yty z3b t3ty*, who may be any of these three or another individual.

idi is the only one attested elsewhere, on a selection of monuments primarily from Abydos.⁴ He would seem to have the same parents, *ḥmi* and *nbt*,⁵ as the vizier *d'w*, also attested from Abydos.⁶ This latter vizier is the addressee of a decree of Pepy II

1 *op. cit.*, 59 (57).

2 *Egyptian Administration*, 12-3.

3 The name of Teti appears in the decoration of the chapel, but it could well be part of the work of *idwt* (Macramallah, *Le Mastaba d'Idout*, pl. V (B), XI (B), in the name '*nḥ-tti*').

4 Baer, *Rank and Title*, 61-2 (73a); Fischer, *AJA* 66 (1962), 65-9.

5 Cairo, CG 1575.

6 Cairo, CG 1431; *Urk.* I, 279.18; Goedicke, *Königl. Dokumente*, Abb. 7.

dated to the year after the eleventh cattle count for the temple of Koptos.¹

In his discussion of the viziers of Pepy II, Kees placed the vizierate of *idi* some time between the date of this decree and the middle of the reign.² The closeness in time of *d'w* and *idi* is perhaps best illustrated by the links they both have with the *imy-r šm'w*, *h3ty-' hwi*,³ although this does not necessarily allow them to be placed in order. Kees believes that the vizierate of *idi* lasted beyond the *sd* festival of Pepy II (perhaps year 30 ?),⁴ because of the existence of a son of his by the name of *ny-hb-sd-ppy*.⁵ Kees supposes this son to have been born after year 30 of Pepy II, and presumed *idi*'s tenure of the vizierate to have continued beyond that point at least until his son reached office-bearing age. However, this name could equally refer to the *sd* festival of Pepy I which is well-attested for the year of his eighteenth cattle-count;⁶ this need not presuppose such a long tenure of the vizierate by *idi*, although there is no reason not to assume that he succeeded *d'w* as vizier.⁷ Kees wishes to identify this *ny-hb-sd-ppy* with the vizier *ny-hb-sd-nfr-k3-r'* (72); against this the latter uses only the *nfr-k3-r'* part of the names of Pepy II in his Saqqara inscriptions.

If *idi* were vizier after the eleventh count of Pepy II, it would imply that the decoration of the sanctuary did not begin until perhaps the first quarter of the reign. This assumes the cattle-count to have been biennial at least on some occasions, as the 'year after' (*rnpt m-ht*) is mentioned in the Koptos decree discussed above. This is significantly later than attested in the fifth dynasty. For example it would seem that the decoration of the mortuary temple of Sahure was substantially complete at his death after a reign of probably twelve years. It is possible that the funerary monument of Pepy II may not have been begun so quickly, given his extreme youth at succession.

Figure 10 illustrates the disposition of the different viziers in the inner chambers of the temple. It is not clear as to the order in which this temple was built; on the analogy of Ptolemaic temples, it would be built from the sanctuary outwards so that the most important rooms would be completed first. If one assumes the same for the decoration, it may be envisaged that the whole area in

1 *Urk.* I, 280.14-5; Goedicke, *op. cit.*, Abb. 8.

2 *Veziat*, 41-2.

3 Shown behind *idi* in the temple of Pepy II (Jéquier, *Pepi II II*, pl. 48); mentioned with *d'w* in the above Koptos Decree (*Urk.* I, 280.16).

4 *op. cit.*, 46-7.

5 Shown on Cairo, CG 1575.

6 *Urk.* I, 93.5-6.

7 Another reason for placing *idi* after *d'w* is the administrative 'reform' proposed by Kanawati (*Governmental Reforms*, 75-77), by which the vizier of Upper Egypt also assumed the title of *imy-r šm'w*. *idi* and not *d'w* held this title, suggesting that he was the later.

Figure 10: Location of Viziers in the Mortuary Temple of Pepy II

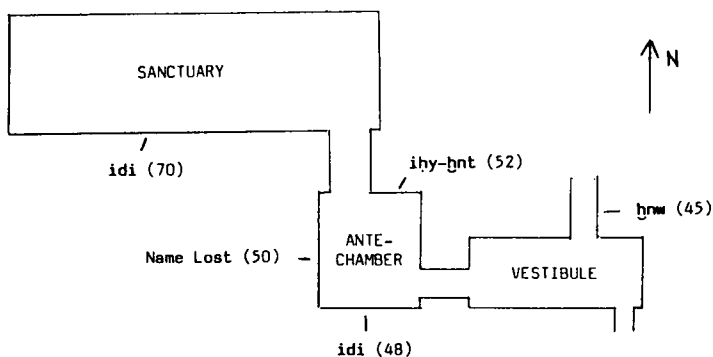

Adapted from Jéquier, *Pepi II II*, pl. 1
(numbers in brackets refer to plates of this publication)

figure 10 could have been carved over a relatively short period of time, making the vizier *hntw* later than *idi* and *ihy-hnt*, who could be contemporary (see further below page 326). The desire to include *hntw* at a relatively late stage would account for his being the only official depicted in the vestibule. It would seem that the official decoration of the temple was not a continuous process carried out through the whole reign, as shown by a number of clearly later additions in poor style.¹

The date of *ihy-hnt* would then seem to be perhaps similar to that of *idi*, and the date of the two of them in the second quarter of the reign of Pepy II provides a basis for a scheme of dating the decoration of the temple.

Suggested Date: Second quarter of the reign of Pepy II.

izi 17

Sources and
Bibliography:

1. Panel of a false door and two wall fragments, exact provenance unknown, probably from Saqqara. Now in Copenhagen, Ny Carlsberg Glyptothek, AEIN 896; *PM* 32, 739.
2. Shown on stela of *nfrrt-wnns*, in the Cairo Museum, CG 1394, exact provenance unknown, but probably from Saqqara; *PM* 32, 736.
3. Eight blocks in Moscow, Pushkin Museum of Fine Arts, Hodjash-Berlev, *Egyptian Reliefs and Stelae in the Pushkin Museum of Fine Arts*, 22-33 (1).

Relevant Titles: *imy-r pr-hd*.

1 For example, the vizier *šn'y*, Jéquier, *op. cit.*, pl. 73.

- Other Titles: 1. imy-r gs-pr, s₃sw n sp₃wt t₃-m_hw ?, s₃m-t₃
sp₃wt šm'w.
 2. zš ' nzwt.
 3. imy-r hwt '3t, imy-r hkr nzwt, wr bzt, hry-
sšt₃, zš ' nzwt.

Hodjash and Berlev present all these different pieces together and conclude that they all originated in the same tomb, almost certainly at Saqqara, and date to the later fourth dynasty. The similarity of the titles on 2) and 3) leave little doubt that they represent the same individual, although the very different titular on 1) poses a slight difficulty.

The false door panel in Copenhagen shows the deceased seated with an offering list before him, and a linen list to the right of that. It is thus in the tradition of the early chapels at both Saqqara and Giza (Chapter 2.I.G.1; II.B). It is a more developed example than that of, for example, mtn,¹ and although a precise date is impossible, the middle fourth dynasty is likely. Certain features on the Cairo stela, particularly the short offering list, place this piece among the early fourth dynasty examples.

Suggested Date: Middle to late fourth dynasty.

izi 18

Source: A false door in the Louvre, C 164 (E 3904), provenance unknown.

Bibliography: Some texts are given in Pierret, **Receuil des Inscriptions du Louvre** II, 76; also examination of original.

Relevant Titles: imy-r prwy-hd.

Other Titles: iwn knwt, imy-r pr-šn', imy-r zš prwy-hd, imy-ht
prwy-hd, imy-ht hm-ntr dd-swt-tti, iry wd₃ n prwy-
hd, wr bzt, mty n z₃ dd-swt-tti, mdw rhyt, hry-tp
nzwt, zš ' h-ntr šm'w, zš w'bty, zš tzwt nbt nt
hnw, smr w'ty.

Although the provenance is unknown, it is probable that this piece originated in the memphite region, as it is firmly in that stylistic tradition. In addition, such pyramid titles as izi held are not found outside memphite tombs.

The use of a panel in the false door of a 'T' shape suggests that the piece does not date before the reign of Pepy II (Chapter 2.I.C). The use of two vertical columns of text per jamb is not normal for doors certainly of the reign of Pepy II (Chapter 2.I.B), and it is thus possible that it is of later date, perhaps the end of the Old Kingdom or the First Intermediate Period. As a South Saqqara origin is unlikely, either Giza or the area of the Teti Pyramid Cemetery at Saqqara suggest themselves as the most likely

1 LD II, 3.

provenances. The false doors from the latter area are the most similar in style (Chapter 2.I.C), suggesting this as its possible origin.

Suggested Date: End Old Kingdom or later.

išfi; twtw 19

Son of 'nh-m-'-hr; zzi (30)

Source: Chapel added to the tomb of his father in the Teti pyramid cemetery at Saqqara.

Bibliography: PM 32, 515.

Relevant Titles: imy-r prwy-hd, imy-r šnwty.

Other Titles: imy-r i'-r nzw̄t, imy-r imw b3w n šhm̄h-ib, imy-r zšwy, imy-r šht htpw, imy-r sqbbwy, imy-r sqbbwy pr-'3, imy-r sdmt nbt, imy-r šwy pr-'3, imy-r šn-t3 nb, imy-r ddt pt qm3t t3, hry-sšt3 n wd̄t-mdw nbt št3t nt nzw̄t, hry-sšt3 n pr-dw3t, hry-sšt3 nzw̄t m swt.f nbt, hry-hb, smr w'ty.

The decoration of this chapel consists only of a false door, and the whole may well be a later addition to the tomb of 'nh-m-'-hr. Given that the date of his father is probably late Teti to early Pepy I, he would be dated perhaps to the middle to late reign of Pepy I. The title sequences could fit a number of periods (VIB, C, E-F),¹ which include that covered by the above date.

Suggested Date: Middle to late reign of Pepy I.

itti 20

Source: Tomb in the Eastern Cemetery at Giza, south of the third row of large double mastabas, G7391.

Bibliography: PM 32, 193; see now, Badawy, *The Tombs of Iteti, Sekhem'ankh-Ptah and Kaemnofert at Giza*, 1-14.

Relevant Titles: imy-r k3t nt nzw̄t.

Other Titles: imy-r pr-'3, w'b, rh nzw̄t, šhd, šhd w'b wr-h'f-r', šhd pr-'3, [sd3wty ntr m] imw '3.

The disposition of the scenes on the west wall of this tomb is not unlike that of šhm-'nh-pt̄h (123), perhaps mid-fifth dynasty, although the false door is of a different type. The remaining elements of the offering list on the south wall do not appear to be arranged in canonical order, but rather seem to be selective, including, for example, milk (ir tt) which does not appear in the full list. This may indicate a date earlier in the fifth dynasty (Chapter 2.I.G.1), although this criterion applies principally to Saqqara.

1 Baer, *Rank and Title*, 64 (94a).

itti may possibly appear in another tomb in the Eastern Cemetery, that of 'nh-h'f-r', G7948.¹ This tomb is probably of early to middle fifth dynasty date, and a similar date may apply to that of itti.

Suggested Date: Perhaps middle fifth dynasty.

itti; 'nh-irs 21

Source: Tomb west of the Step Pyramid at Saqqara, D 63, adjoining that of pth-htp I (49) to the south.

Bibliography: PM 32, 598.

Relevant Titles: imy-r k3t nt nzwt.

Other Titles: imy-r 'h, imy-r wd'-mdw n wsht, imy-r mstt, wr md šm'w, hrp mrwy nzwt, hrp tm3, smsw izt, smsw izt m prwy.

According to Mariette, the join between this mastaba and that of pth-htp I shows that the latter is the earlier,² thus indicating the reign of Djedkare as the earliest possible date. The location of the false door in the centre of the west wall of an 'L'-shaped north-south chapel follows the tradition found most commonly in the fifth dynasty. This door does not have a torus and cornice, but has an offering list on the inner jambs, a further feature of the fifth dynasty (Chapter 2.I.G.2). This evidence suggests that it does not postdate pth-htp I by very many years.

Suggested Date: Later fifth dynasty.

idw I; nfr 22

Source: Tomb in the Western Cemetery at Giza, G5550, north of the enclosure wall of the pyramid of Khufu.

Bibliography: PM 32, 165. There is an additional block in the Field Museum of Natural History, Chicago 31693 (unpublished).

Relevant Titles: imy-r prwy-hd, imy-r zš [' nzwt], imy-r šnwty, imy-r k3t nbt nt nzwt, t3yty z3b t3ty.

Other Titles: iwn knmwt, [imy-r] izwy [hkr] nzwt, imy-r w'bt, imy-r w'bty, imy-r wdt-mdw nbt št3t nt nzwt, imy-r r-pr, imy-r hwt ihwt, imy-r hnw, imy-r šht nbt, imy-r gswy-pr, mdw rhyt, hry-sšt3 nzwt, hry-tp nzwt, z3b 'd-mr, zš ' nzwt.

The chapel of this tomb has been extensively damaged, although it has been possible to reconstruct much of the false door, which is of the type with cornice and torus moulding. This door has the

1 Harpur, JEA 67 (1981), 24-35.

2 Mastabas, 357.

small apertures typical of the sixth dynasty, which date is supported by the tomb's location outside the main part of the Cemetery en Echelon, in use mainly during the fifth dynasty. The general appearance of the false door is not unlike those of *mrri* (67) and *mhw* (69) of Saqqara, both belonging to the middle of the sixth dynasty.

The title sequences of Baer admit of any of the periods VIB-C, E-F.¹ It would seem that as most of the viziers of Teti and the later reign of Pepy II were buried near the respective pyramids, the period of the reign of Pepy I to early Pepy II would be the most likely for this man and the others like him.² It has been said that the tomb is rather small for the rank of its owner,³ but this is also true of other tombs from the period suggested here, such as that of *r'-wr* (93) at Saqqara.

Suggested Date: Mid-sixth dynasty, perhaps the later reign of Pepy I to early Pepy II.

idw 23

Source: Tomb north of the first row of large mastabas in the Eastern Cemetery at Giza, G7102.

Bibliography: *PM* 3², 185-6; see now Simpson, *Giza Mastabas II*, 19-31.

Relevant Titles: *imy-r hwt wrt*.

Other Titles: *iwn knmwt*, *imy-r wpt htpw ntr*, *imy-r wpt htpw ntr m prwy*, *imy-r zš mrt*, *wd'-mdw*, *mdw rhyt*, *hm-ntr m3't*, *hry-sšt3 n wd'-mdw*, *hnty-š mn-nfr-mry-r' ppy*, *hry-tp nzwt*, *zš '-nzwt*, *zš '-nzwt hft-hr*, *sm3' wd'-mdw*, *shd w'b 3ht-hwfw*, *shd w'b wr-h'f-r'.*

This man is presumably related to *q3r* (135), the owner of the neighbouring tomb G7101. Neither can antedate the reign of Pepy I as may be seen from the titles.

The relationships of these men and their dating have been discussed on several occasions. Baer places *idw* in period VIC, and *q3r* in VID.⁴ On the basis of tomb size, Kanawati has dated *idw* and *q3r* to early reign of Wenis and late Wenis respectively.⁵ Simpson has discussed the relationships and draws attention to the

- 1 Middle reign of Teti to middle reign of Pepy II; **Rank and Title**, 62 (78).
- 2 cf. Kanawati, **Governmental Reforms**, 34.
- 3 Baer, *loc. cit.*, is one such example.
- 4 *idw*, reign of Merenre to early Pepy II, *op. cit.*, 62 (77); *q3r*, about twenty years later than VIC, *id.*, *ib.*, 136-7 (495).
- 5 **Egyptian Administration**, 155-6, where he attempts to reconcile these dates with the evidence of the titles with the names of Pepy I.

idw who occurs in the Abusir Papyri.¹ This text has been dated by Posener-Kriéger to the period previous to 'an 15 d'Isesi'.² The derivation of this date is tortuous in the extreme: the verso (fragment 69A) shows the date, which is in fact **rnpt zp 8** of an unspecified king, and it is presumed that the verso was written before the recto. Determining the reign is very much less simple: a **wr-'-i mn-htpw-k3k3i** is found in this document, who may perhaps be the man who held the same office on a sealing of Izezi.³ This is far from convincing, and it must be stated that Posener-Kriéger is aware of the problems. Consequently, it is not necessary to follow Kanawati (*loc. cit.*) and regard **idw** as a very old man at death.

Simpson's remaining arguments for **idw** being the father of **q3r** are quite probable, and are supported by the results of Baer. If so, the other name of **q3r** (**mry-r'-nfr**) may actually be a reflection of his birth in the reign of Pepy I. **idw** may date early in the reign and **q3r** to its latter part and perhaps the reign of Merenre.

Suggested Date: Early to middle reign of Pepy I.

'nh-ir-ptḥ 24

Source: Tomb in the south-west corner of Cemetery G4000 at Giza, G4811 + 4812, set up by his son **rdi-n-ptḥ**.

Bibliography: **PM** 32, 138; additional information from excavation records in Boston.

Relevant Titles: **imy-r k3t nt nzwṯ**.

Other Titles: **imy-r w'bt, imy-r ḥmwṯ pr-'3**.

The location of this tomb in Cemetery G4000 must date its construction later than that of the nucleus mastabas. One noticeable feature of the plan is the east-west offering chapel, with a complex false door, a combination which first appears at Giza in the tomb of **sndm-ib; inti** (120) in the later fifth dynasty. In addition, the extreme left-hand column of inscription includes a title written with plural strokes, rarely found before the middle sixth dynasty.⁴ This official is thus unlikely to be earlier than the beginning of the sixth dynasty.

Suggested Date: Perhaps early to middle sixth dynasty.

1 *op. cit.*, 2 n.4, referring to **HPBM**, pl. LXVIII. This **idw** held the title of **zš mrt** in common with **idw** of G7102.

2 **ArchAb** II, 489.

3 Berlin 16300; Kaplony, **Die Rollsiegel des alten Reiches II**, 321, Taf. 87.

4 For example, in the inscriptions of **nhbw**, **Urk. I**, 215-9; for earlier examples and general discussion, see Edel, **Altäg. Gramm.**, 119-20 (§ 276-8), and Gardiner, **EG**, 535-6 (22).

'nh-irs 25

- Source: Tomb at North Saqqara, no. 15 (B 16).
 Bibliography: PM 32, 452.
 Relevant Titles: imy-r k3t nbt nzw. nzw.
 Other Titles: imy-r d3d3t nzw nt wd'-mdw nb, wr md šm'w, wd-mdw hry-wdb, [hm-ntr] sš3t, hry-wdb hwt-'nh, hry-sš3, hry-sš3 nzw, hrp 'h, z3b 'd-mr.

Baer has dated this tomb to period VB or quite possibly earlier.¹ The cruciform chapel is a feature of the fourth and early fifth dynasties at Saqqara (Chapter 2.I.H). The false door, although not published with an illustration, may be reconstructed as having three columns of text on the inner jambs, and probably two at the rear of the central niche. It is perhaps not dissimilar to that of mry (58) of the later fourth dynasty. The panel would appear to have a short uncanonical offering list, which again points to the early fifth dynasty (Chapter 2.I.G.1).

Suggested Date: Early fifth dynasty.

'nh-izzi 26

- Source: Tomb near the north-east corner of the Step Pyramid enclosure at Saqqara, no. 85 (D 8, S 910).
 Bibliography: PM 32, 489.
 Relevant Titles: imy-r k3t nbt nt nzw.
 Other Titles: imy-r wdt-mdw nbt nt nzw, imy-r mš', mniw k3w, mdw nfrw, hry-sš3 nzw, hrp imw hr m h3t.f, z3 nzw, smr w'ty, sd3wty ntr, sd3wty ntr m imwwy, sd3wty ntr m imwwy '3.

This tomb is dated by Baer to his period VC, which date, if correct, might suggest that his name is a reflection of birth in the reign of Djedkare.² 'nh-izzi is often discussed in the same context as k3i-m-tnt (146), the owner of a nearby mastaba,³ and there are a number of features which suggest that they might be related. Firstly, both held the following titles: imy-r mš', imy-r k3t nbt nt nzw, imy-r wdt-mdw nbt nt nzw, sd3wty ntr, sd3wty ntr m imwwy '3, smr w'ty and z3 nzw. This list incorporates the bulk of their titles, and such similarity is what one might expect of a father and son. Their chapel plans are not dissimilar: both have an entrance with two pillars, and moderately complex chapels, not unlike those of their possible contemporaries at Giza, sndm-ib; inti and sndm-ib; mhi. One difference from the latter chapels is that k3i-m-tnt and 'nh-izzi placed their false doors in north-south offering rooms rather than east-west ones, although the door

1 Rank and Title, 63 (88).

2 Later reign of Djedkare to middle Wenis; *op. cit.*, 60 (64).

3 For example, Schmitz, *Königssohn*, especially p. 88.

of 'nh-izzi was of the cornice and torus moulding type usually found in east-west chapels. Finally, the locations of their tombs are sufficiently similar so as not to prohibit a relationship.

k3i-m-tnnt may be dated by his connections with the vizier r'-špss (95), who is mentioned in his biography.¹ There are possible parallels between the sons of these two men, 'nh-izzi and pr-nb.² Baer has observed (*loc. cit.*) that a block from the tomb of 'nh-izzi was delivered in error to that of pr-nb, which points to their being under construction simultaneously. pr-nb may be dated to the first half of the reign of Wenis on the basis of the independent date for his father, and the same is in all probability true for 'nh-izzi.

Suggested Date: First half of the reign of Wenis.

'nh-wsr-k3f 27

Source: Tomb adjacent to the mortuary temple of Neweserre at Abusir.

Bibliography: PM 3², 344.

Relevant Titles: imy-r k3t nbt nt nzwt.

Other Titles: /// pr n nzwt, imy-r hwwt-ntr, imy-r hwt ihwt, imy-r ht nbt nt nzwt, imy-r sp3wt t3-mhw m gswy-pr, imy-r gswy-pr, imy-r tniw, 'd-mr dp, wr md šm'w, mdw rhyt, mdw k3-hd, nst hntt, h3ty-', h3t tnt iwnw ?, hm-ntr inpw, hm-ntr m3't m swt.s nbt, hm-ntr hr m dmit nbt, hm-ntr hz3t, hm-ntr hqt, hm-ntr s3hw-r' m swt.f nbt, hm-ntr srt, hry-s3t3, hry-s3t3 n r-3w h3swt m gswy-pr, ht h3, hry-tp nzwt m prwy, z3b 'd-mr, smsw izt ?, smsw n iwnw h3t tnw, shd w'b h'-b3w-s3hw-r'.

It is possible that the slightly off-centre plan of the mortuary temple of Neweserre is due to the previous existence of this mastaba. Consequently the tomb could be of the reign of Sahure or Neferirkare, possibly the latter as his pyramid is the nearer. A man by the name of 'nh-wsr-k3f appears in the reliefs of the mortuary temple of Neweserre.³ As the name is not common, it is probable that it is indeed the owner of this tomb that is represented.

Baer dates the tomb to the reign of Sahure, in the period preceding the introduction of a system of ranking titles, having initially opted for that of Neweserre on the basis of the relief in the mortuary temple.⁴ The tomb could have been built either before the appearance of this system or in its early years, but 'nh-wsr-k3f could have easily lived on into the reign of Neweserre. If his name is a reflection of birth in the reign of Weserkaf, then

1 Urk. I, 183.12 and 17; Schott, *Fs Otto*, 450 (10, 12).

2 Almost certainly a son of r'-špss, see Baer, *op. cit.*, 71 (142).

3 Borchardt, *Ne-user-re'*, Abb. 50.

4 *op. cit.*, 68-9 (123a).

he would hardly have been old enough to have held office before the reign of Neferirkare, but could have constructed his tomb prior to the building of the pyramid complex of Neweserre.

Suggested Date: Reign of Neweserre or a little earlier.

'nh-m-'-r' 28

Source: Tomb at the eastern edge of the Eastern Cemetery at Giza, G7837 + 7843.

Bibliography: *PM* 3², 206; virtually unpublished. For one scene, see now Simpson, *Fs Edel*, 494-5, fig. 3; other information from excavation records in Boston.

Relevant Titles: *imy-r šnwt, imy-r šnwt swt ḥtpw df3w.*

Other Titles: *imy-r i'-r nzwt, imy-r swt ḥtpw df3w, w'b nzwt, nst ḥntt, rh nzwt, ḥm-ntr m3't, ḥry-sšt3, ḥry-sšt3 nb.f, ḥrp zš, ḥry-tp šnwt, zš n sḥt ḥtp nzwt, zš nzwt, šhd zš '-nzwt šnwt*

This tomb has been placed in the early part of the fifth dynasty by Smith, presumably on the basis of the existence of rock-cut statues of the deceased.¹ Baer suggests the late fifth dynasty or later.²

The only scene published from this tomb shows the deceased being carried back from inspecting the work on his tomb.³ Palanquin scenes first appear in the tomb of *nfr-m3't* (85) at Meydum and continue at least until the reign of Pepy II.⁴ Late fifth and early sixth dynasty examples are particularly common, and from this period at Giza may be noted those in the tombs of *sndm-ib; inti* (120), *wr-ḥww, iti-sn, and ny-m3't-r'*. This latter example is the only exact parallel to the scene of 'nh-m-'-r', which gives force to a late fifth dynasty date.

There is shown on the false door of *ny-k3-r'* (80) a son by the name of 'nh-m-'-r' with the title of *imy-r šnwt*, who could be our 'nh-m-'-r'.⁵ The middle fifth dynasty date deduced below for *ny-k3-r'* would not be at odds with one in the late fifth for his son. It would naturally be preferable that the two men be buried at the same site, but this need not rule out this possibility.

Suggested Date: Late fifth dynasty.

1 *Sculpture*, 189-90.

2 *Rank and Title*, 64 (92).

3 Simpson, *loc. cit.*

4 See the lists in Junker, *Giza XI*, 249 ff. and Klebs, *Reliefs des alten Reiches*, 27-9, whence references to the following officials may be found.

5 I owe this suggestion to Dr. E. Brovarski.

'nh-m'-r' 29

- Source: Rock-cut tomb in the Central Field at Giza, south of the western end of the causeway of the pyramid of Khafre.
- Bibliography: PM 32, 246.
- Relevant Titles: t3yty z3b t3ty.
- Other Titles: iry p't, h3ty-', hry-hb hry-tp n iti.f, z3 nzwt n ht.f smsw, sd3wty bity n iti.f.

An 'eldest king's son of his body', 'nh-m'-r' was a true son of one of the fourth dynasty rulers, as suggested by the presence of titles with n iti.f. From the location of the tomb Khafre would seem to be the most likely king. The identity of his mother is not revealed in the tomb, but some suggestions may be made on the basis of two little-known blocks from the tomb of nb-m-3ht (81). The first bears two vertical columns of text, /// n h /// and /// 'nh m ///,¹ which could be reconstructed as [z3 nzwt] n h[t.f] 'nh-m-['-r']. No other men with this name and title are known. In the same tomb there is a very similar block with the name and title of ny-wsr-r', almost certainly the brother of nb-m-3ht and the owner of a tomb further to the south in the same cliff.² 'nh-m'-r' could also have been a younger brother of nb-m-3ht, although one might then expect him to be shown in the tomb of the latter's mother mrs-'nh III together with nb-m-3ht, ny-wsr-r' and dw3-r'. The second piece from the tomb of nb-m-3ht may suggest another explanation. A statue-base carries the inscription /// ht.f smsw s ///,³ presumably to be reconstructed [z3 nzwt n] ht.f smsw plus a name, and the only holder of that title known at any period from Giza whose name would fit the traces is shm-k3-r' (125). Unless it were simply thrown away there, it would seem that shm-k3-r' possessed some sort of statue in this tomb. He was certainly not a true brother of nb-m-3ht, and so one may perhaps apply the analogy to the occurrence of the name of 'nh-m'-r'.

For details of other features which possibly influence the date, see the discussion of iwn-minw (7). 'nh-m'-r' could have been the youngest son of Khafre to have become vizier, as he is the only such holder of this office not to have been buried in a tomb in the cliff face.

Suggested Date: Beginning of the fifth dynasty.

-
- 1 Hassan, Giza IV, fig. 86.
 - 2 Hassan, *op. cit.*, fig. 85. As brother of nb-m-3ht (that is, son of mrs-'nh III), see Dunham-Simpson, Giza Mastabas I, 13 n. 29, 25; tomb, PM 32, 234.
 - 3 Hassan, *op. cit.*, 148 (2).

'nh-m'-'hr; zzi 30

Source: Second tomb in the 'Rue de Tombeaux', Teti pyramid cemetery, Saqqara.

Bibliography: PM 3², 512-5; see also Badawy, *The Tomb of Nyhetep-Ptah at Giza and the tomb of 'Ankhm'ahor at Saqqara*, 11-57.

Relevant Titles: imy-r prwy-hd, imy-r hwt wrt, imy-r zš ' nzwt, imy-r k3t, imy-r k3t nbt nt nzwt, imy-r k3t nbt nt nzwt m t3 r dr.f, t3yty z3b t3ty.¹

Other Titles: iwn knmwt, im3-', imy-iz nhn, imy-r izwy hkr nzwt, imy-r zšwy, imy-r zšwy m3', imy-r zšwy n šhmh-ib, imy-r sđmt nbt št3t, imy-r šn-t3 nb, iry p't, mniw nhn, mdw rhyt, mdh zš nzwt, h3ty-', hm-ntr m3't, hm-ntr hqt, hry-sšt3 n wdt-mdw nbt, hry-sšt3 n wdt-mdw nbt št3t nt nzwt, hry-sšt3 n

nzwt m swt.f nbt, hry-tp nhb, hnty-š dd-swt-tti, ht , hry-hb hry-tp, hry-tp nzwt, sm, shd hm-ntr dd-swt-tti.²

In Firth's discussion of the relative dates of the great mastabas of the Teti pyramid cemetery, that of 'nh-m'-'hr is not mentioned.³ For general details of the dating of this group of tombs, see below under mrrw-k3i (68). The tomb of 'nh-m'-'hr is dated to period VIB by Baer, the same as nfr-sšm-r' (88) the owner of the neighbouring tomb to the south.⁴ The relative location of these two tombs suggests that 'nh-m'-'hr 's is the later. There are no indications that the career of 'nh-m'-'hr continued into the reign of Pepy I, at least for long enough for the name of that king to appear in his tomb.

Suggested Date: Middle to late reign of Teti.

'nh-m'-'k3i 31

Source: Tomb at North Saqqara, no. 67 (D 16).

Bibliography: PM 3², 481.

Relevant Titles: imy-r hwt wrt, imy-r k3t nt nzwt.

Other Titles: iwn knmwt, imy-r wpt nt nzwt, imy-r wsht, imy-r pr 'h3w, imy-r swt htpw df3w, w'b nzwt, wr md šm'w, wd-mdw št3 n hry-wdb, mdw rhyt, nst hntt, hm-ntr

-
- 1 t3yty z3b t3ty, imy-r prwy-hd and imy-r zš ' nzwt only appear in the innermost parts of the tomb or in the burial chamber, suggesting that it may be possible to divide the titles into two phases of his career.
 - 2 Due to the damage suffered by parts of the tomb, especially to the false door which has almost completely disappeared, it is almost certain that his titulary was more extensive than that given here, perhaps including more relevant titles.
 - 3 *Teti Pyramid Cemeteries* I, 15.
 - 4 Middle Teti to middle Pepy I, *Rank and Title*, 64 (94).

m3't, hm-ntr mn-swt-ny-wsr-r', hm-ntr r' m nbn-r', hm-ntr hqt, hm-ntr s3hw-r', hry-wdb m hwt-'nh, hry-sst3, hry-sst3 n wd'-mdw, hry-sst3 n wdt-mdw nt nzwt, hry-sst3 n mdw ntr, hry-sst3 n ntr.f, hrp zš wsht, hry-tp nzwt, z3b 'd-mr.

The form of the false door of 'nh-m'-k3i suggests that Baer's date of period VIC may be too late.¹ The door has wide jambs with larger figures of the deceased on the outer than on the inner, no cornice and torus moulding, and large panel apertures each containing an offering list. Given the important titles of this man, if he had lived in the middle sixth dynasty, it might be expected that he would have possessed the newer type of false door prevalent among officials at that time, one feature of which was the presence of the torus and cornice (Chapter 2.I.A). The offering list of this door and the wide jambs have several parallels in the middle of the fifth dynasty (Chapter 2.I.G.2 and B). The raised relief of the door is also characteristic of the fifth dynasty (Chapter 2.I.F.1). It is felt that this evidence is sufficiently strong to warrant the rejection of the date of Baer.²

Suggested Date: Mid-fifth dynasty, perhaps not long after the reign of Neweserre (?).

'nh-mry-r'; ny-sw-ihy 32

Source: Tomb east of the Step Pyramid at Saqqara, E 13, exact position unknown.

Bibliography: PM 32, 586.

Relevant Titles: imy-r k3t nbt nt nzwt.

Other Titles: imy-r r-3w, imy-r hnty-š pr-'3, hq3 hwt, hry-hb, hry-tp nzwt pr-'3, smr w'ty, smr w'ty m3'.

The only monument from this tomb is the false door in Cairo, dated by Baer to his period VIB, which accords with the presence of the mry-r' element in the name.³ This door is a large example with cornice, torus and three jambs. In many ways it is a simpler version of the door of nfr-sšm-r'; šš'i (88); there is one significant difference, a small extra 'lintel' above the panel and beneath the architrave with his name and titles. This feature is also found on the false door of išfi; twtw (19), and may have later been assimilated with the panel to form the 'I'-shaped type found in the reign of Pepy II.

The employment of plural strokes in the inscriptions is further attested in the mid-sixth dynasty in the texts of nhbw (90),

-
- 1 Later reign of Pepy I to early Pepy II, *Rank and Title*, 64 (95).
 - 2 Some of the title sequences can actually be fitted into those of the mid-fifth dynasty (VB), given the complexity and number of variations possible at that time.
 - 3 Middle reign of Teti to middle Pepy I, *op. cit.*, 80 (185).

although they are most common in the later Old Kingdom. These features all suggest a date in the middle of the sixth dynasty.

Suggested Date: Middle sixth dynasty, perhaps later reign of Pepy I or Merenre.

'nh-mry-r' 33

Son of mhꜣw (69)

Source: Chapel in the tomb of his father in the Wenis cemetery at Saqqara, south of the temenos wall of the Step Pyramid.

Bibliography: PM 32, 621-2; unpublished - personal examination of chapel.

Relevant Titles: imy-r prwy-hꜣ, imy-r zš 'nzwꜣt, imy-r šnwꜣty, imy-r kꜣt nbt nt nzwꜣt, tꜣyꜣty zꜣb tꜣty.

Other Titles: imy-r i'-r nzwꜣt, imy-r gs-pr, imy-r gs-pr mꜣ', 'd-mr dp, hꜣty-', hꜣty-' mꜣ', hry-sšꜣtꜣ n wꜣdꜣt-mdw nbt, hry-sšꜣtꜣ n pr-dwꜣt, hrp sndyt nbt, hry-hb, hry-hb hry-tp, sm, smr w'ty, smsw snwꜣt, šꜣd hm-nꜣr mn-nfr-mry-r' ppy, sdꜣwꜣty bity.

The tomb of mhꜣw will be dated below to the reign of Pepy I. On the basis of a generation of twenty to twenty-five years, one would expect mhꜣw to date to the end of the reign of Pepy I or later. The latter official held priestships of Teti and Pepy I, while 'nh-mry-r' held only a priestship of the latter, which is in accordance with the later date. The chapel may have been built along with that of mhꜣw, but was not necessarily decorated at that time.

Suggested Date: Perhaps end of the reign of Pepy I to early Pepy II.

'nh-hꜣf 34

Source: Mastaba in the Eastern Cemetery at Giza, G7510.

Bibliography: PM 32, 196; almost completely unpublished - information from examination of excavation records and material in Boston.

Relevant Titles: [imy-r] kꜣ[t nbt nt nzwꜣt], [tꜣyꜣty] zꜣb tꜣty.

Other Titles: imy-r wsꜣt, imy-r ht nbt, iry p't, 'ꜣ dwꜣw, wr [md šm'w], wr 5 pr-dꜣwꜣty, [mniw] nꜣn, [mdw] hp, hꜣty-', hm-nꜣr bꜣ 'nꜣt, hry-tp nꜣb, hꜣs inpw, [hrp] iꜣt [nbt nꜣrt], hrp 'h, hrp mꜣt tꜣ-mꜣw [šm'w], hry-hb, hry-hb [hry]-tp, [zꜣ] nzwꜣt [n ht.f], zꜣ [nzwꜣt] n ht.f smsw, smsw izt, sdꜣwꜣty bity.

The parentage of 'nh-hꜣf and his exact position in the royal family of the fourth dynasty are less than certain. Reisner and Smith considered him a son of Sneferu by an unspecified queen, who then married a senior daughter of that king and a principal queen,

htp-hrs; his tomb is then dated to the reign of Khafre.¹ This is based solely on **htp-hrs**'s (reconstructed) priesthood of Sneferu and the historical associations of her name.

A different conclusion may be reached by reconsidering Reisner's view of the relative arrangement of the Giza cemeteries. He considered that the Eastern Cemetery consisted of twelve initial cores, later modified into eight, east of the queens' pyramids, followed by six further ones including G7510.² This is based on his typology of the twelve cores as type IVi and that of the others as IViii. However, it has been suggested above that the sequence of appearance of chapels with two false doors at Giza points to this tomb dating to the reign of Khufu (page 42). For the tomb of 'nh-h3f to have been prepared in the reign of Khufu, it is perhaps likely that he was of the same generation as that king, very possibly a son of Sneferu.

Smith puts his death at an advanced age, because of the appearance of a grandson in the tomb,³ but assuming that the first children were born while their parents were young, he could have easily been a grandfather by the age of forty. The decoration of the panel of **htp-hrs** points to it as being one of the earliest examples from the Eastern Cemetery (Chapter 2.II.B). If 'nh-h3f is to be paralleled with **hm-iwnw**, one might date him to the middle of the reign of Khufu.

Suggested Date: Middle reign of Khufu.

'nh-h3f; q3r 35

Source: Rock-cut tomb in the Central Field at Giza, north of the 'pyramid town' to the east of the tomb of **hnt-k3ws**, shared with son **ny-s'nh-3ht**; **iti** (73).

Bibliography: **PM** 32, 257-8.

Relevant Titles: **imy-r pr-hd**, **imy-r prwy-hd**.

Other Titles: **imy-r izwy hkr nzwt**, **imy-r w'bty**, **imy-r prwy-nwb**, **wr bzt**, **htm df3w bity**, **hry-tp nzwt**, **z3b 'd-mr**, **smsw izt**.

The title sequences of 'nh-h3f are placed by Baer in his period VIC.⁴ The only feature usable for dating is the poorly preserved false door, which is a two jambed example, apparently without cornice or torus; this form is found in both the fifth and sixth dynasties at Giza. The forms of the **pr-hd** group from this tomb vary between that most common in the fifth dynasty and that most typical of the sixth, and it is thus possible that the tomb belongs to a period transitional between these two writings, at the end of

1 Reisner-Smith, **Giza II**, 11, fig. 10.

2 **op. cit.** I, 75, 212.

3 Reisner-Smith, **op. cit.**, 11.

4 Middle sixth dynasty (Merenre and slightly later), **Rank and Title**, 65 (100).

the fifth or beginning of the sixth (see below page 279-80).

Suggested Date: Perhaps early sixth dynasty.

'nh-hwfw 36

Source: Sarcophagus found in the Eastern Cemetery at Giza, possibly from tomb G7750. Now Cairo, CG 1790.

Bibliography: PM 32, 216.

Relevant Titles: imy-r k3t nbt nzwt.

Other Titles: w' hz3t, mniw nhn, mdw hp, mdw k3-hd, r p nb, hry-wdb hwt-'nh, hrp 'h, smr w'ty, sd3wty bity.

The attribution of this piece to G7750 is due to a suggestion of Donadoni Roveri, who would date it to the later fourth dynasty.¹ His titulary is typical of fourth to early fifth dynasty high officials, containing many high honorific titles. Furthermore, the

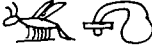
writing of the title sd3wty bity as  is perhaps more typical of the fourth dynasty, after which time  is the more usual.²

Suggested Date: Perhaps late fourth or early fifth dynasty.

w3š-ptḥ; izi 37

Source: Tomb at North Saqqara, no. 24 (D 38).

Bibliography: PM 32, 456.

Relevant Titles: imy-r zš ' nzwt, imy-r k3t nbt nt nzwt, t3yty z3b t3ty.

Other Titles: iwn knmwt, imy-iz, imy-iz nhn, iry nfr-h3t, '3 dw3w, wr idt, wr ht, mniw nhn, mdw rhyt, h3ty-', hm i3qs, hm-ntr m3't, hm-ntr nhbt, hm-ntr hr inpw,

hm-ntr hr inpw hnty pr smswt, hm-ntr  smswt, hry-sšt3 n pr-dw3t, hry-sšt3 n mdw ntr, hry-tp nhb, hts inpw, hrp i3t nbt nrt,

hrp wsht, ht , hry-hb, hry-hb hry-tp, hry-tp nzwt, zš md3t ntr, sm3 minw, sm3 hr, smr w'ty, smsw snwt, sdt nzwt.

From the damaged biographical text in this tomb, it seems w3š-ptḥ was probably taken ill in the presence of Neferirkare, who

- 1 I Sarcophagi egizi dalle origini alle fine dell'antico regno, 114-5 (B15), no reason given. This provenance is somewhat doubtful, as one might expect the owner of G7750 to have been a king's son on the analogy of the neighbouring tombs.
- 2 But compare Fischer, *Coptite Nome Dynasties*, 126.

afterwards commanded the events to be recorded in his tomb.¹ This was built by his son, perhaps as w3š-ptḥ died unexpectedly because of this illness.

Baer takes the title sequences from this tomb as the basis for the beginning of his ranking period VB, in the reign of Neferirkare.² As his name has not survived in the decoration of the pyramid temple of Sahure, he may date to the later part of the reign of Neferirkare (cf. wr-b3w-b3 (39) below).

Suggested Date: Middle to late reign of Neferirkare.

wr-irni 38

Source: Tomb at North Saqqara, no. 62 (D 20).

Bibliography: PM 32, 478-9.

Relevant Titles: imy-r pr-hd.

Other Titles: ḥm-ntr r' m nḥn-r', ḥm-ntr r' m st-ib-r', zš hkr nzwṯ.

The only elements of this tomb to have survived are a group of statues, principally of dependents. The tomb is situated to the north of those of ty (157) and k3i (136), both of which are to be dated to about the middle of the dynasty. These are the only indications available for the purposes of dating.

Suggested Date: Perhaps middle fifth dynasty.

wr-b3w-b3 39

Source: Depicted among the courtiers in the mortuary temple of Sahure at Abusir.

Bibliography: Borchardt, S'a3hure' II, Bl. 17 (left).

Relevant Titles: t3yty z3b t3ty.

Other Titles: None given.

Assuming the construction of the temple and pyramid of Sahure to have begun shortly after his accession to the throne, it is perhaps likely that the decoration of the outer parts of the temple, in which this depiction appears, would have taken place towards the end of the reign - the equivalent part of the temple of Neferirkare was unfinished at his death, suggesting that it was the last area to be built. Other parts of the same relief show Neferirkare as king, suggesting the same conclusion.³

Suggested Date: Late reign of Sahure, and possibly later.

1 Urk. I, 40-5.

2 Rank and Title, 224, 230.

3 Neferirkare also appears in a nearby relief, Borchardt, op. cit., Bl. 32.

wr-k3w-b3; ikw 40

- Source: A small offering-room amid the tombs of the **sndm-ib** family at Giza, G2383.
 Bibliography: Brovarski, *L'Égyptologie en 1979* II, 120 (fig. 21).
 Relevant Titles: **imy-r hwt wrt, t3yty z3b t3ty.**
 Other Titles: **smr.**

The chapel was built against the southern face of the tomb of **sndm-ib; mhi** (121), G2378. The location might suggest some connection between **wr-k3w-b3** and the **sndm-ib** family, but there is no similarity in their titles - none mention building or labour organisation.

The small size of the offering room may reflect a very late Old Kingdom date. The false door is also of very small size for a man with such a high title. One feature often found with doors of late date, the so-called 'I'-shaped panel (Chapter 2.I.D), is not evident here. The insertion of such a tombs among those of the **sndm-ib** family must presumably have been made later than the principal burials, the latest of which dates to the reign of Pepy II (**impy** (62)). These vague indications suggest the end of the Old Kingdom or later.

There is additionally a statue of a **wr-k3w-b3; ikw** found in the temple of the pyramid of Menkaure, who bore the titles of **smr w'ty** and **hry-hb hry-tp** among others. This may have belonged to the same man as the false door, although neither relevant title is found so as to confirm this suggestion.¹

Suggested Date: Late Old Kingdom or later.

wr-k3-ptb 41

- Source: Tomb at North Saqqara B 15.
 Bibliography: **PM** 3², 491.
 Relevant Titles: **imy-r šnwt.**
 Other Titles: **rh nzw.**

This tomb chapel seems to have been of the east-west type, with a parallel serdab to the south. Inscriptions were found on the inner jams of the false door, and offering bearers on the outer ones. Such an arrangement is typical of the mid-late fifth dynasty (Chapter 2.I.B and F.3). Baer also suggests the mid-fifth dynasty or later, and there is no further evidence for a more precise date.²

Suggested Date: Perhaps mid to late fifth dynasty.

1 Cairo, JE 41978: Reisner, **Mycerinus**, 13-14 (43), pl. 63 b, e.
 2 **Rank and Title**, 68 (119).

b3-b3f 42

Source: Mastaba in the Cemetery en Echelon in the western field at Giza, G5230.

Bibliography: PM 32, 155-7; the statues found by the Harvard-Boston expedition are unpublished, and information on them derives from examination of the originals and the expedition records.

Relevant Titles: *imy-r k3t nbt nt nzwt, t3yty z3b t3ty.*

Other Titles: *imy-iz nhn, iry p't, '3 dw3w, 'd-mr dw3-hr-hnty-pt, wr idt, wr ht, wr 5 pr-dhwty, mniw nhn, h3ty-', hm i3qs, hm hpwy, [hm] hr sw3, hm-ntr wnw-r hnty minw, hm-ntr hr qm3-', hm-ntr dhwt, hry-sst3, hry-sst3 pr-'3, hry-sst3 n pr-dw3t, hry-sst3 n mdw ntr, hry-tp nhb, hrp 'h, hrp*

[m]rt, ht , hry-hb, hry-hb hry-tp, z3 nzwt, z3 nzwt n ht.f, smr, smr w'ty, smr w'ty n iti.f, smsw snwt, sdt nzwt.

Among the tombs of viziers at Giza, that of b3-b3f is unique in that there does not seem to be a single decorated surface in the entire chapel; rather the effort was put into an almost unequalled number of statues (at least thirteen). Reisner regarded this man as a son of *dw3-n-r'* (161), owner of the nearby tomb G5110.¹ One major problem with this interpretation is the appearance of the title *smr w'ty n iti.f* on statue Boston, Museum of Fine Arts 34.1461. The epithet *n iti.f* is usually taken as perhaps the clearest evidence of true royal filiation. However, this is the

Statue	1	2	3	4	5
Vienna 7785				X	X
MFA 21.931			X		
MFA 34.235	X	X	X		X
MFA 34.1461	X	X	X	X	
MFA 21.953	X		X		
MFA 21.955			X		
MFA 14-11-78	X	X		X	
MFA 14-11-80				X	
*				X	

* is the fragment Junker, Giza VII, Abb. 64 (right upper)
MFA - Museum of Fine Arts, Boston.

Key to Columns:

- | | | | |
|---|------------------------------|---|-------------------------------------|
| 1 | <i>t3yty z3b t3ty</i> | 2 | Titles incorporating <i>z3 nzwt</i> |
| 3 | <i>iry p't</i> | 4 | <i>h3ty-</i> |
| 5 | <i>imy-r k3t nbt nt nzwt</i> | | |

1 Reisner, Giza I, 69 n. 1.

only occurrence outside the recognised royal cemeteries at Giza.

It is however possible that b3-b3f may have acquired this epithet with a promotion. The table above shows the distribution of several of his most important titles on nine of these statues. It will be seen that the titles compounded with z3 nzwt only appear on the statues that also bear the title of t3yty z3b t3ty; it is on one of these that the title smr w'ty n iti.f is found. It is possible that his career could be divided into two phases: his first statues were carved when he was h3ty-' and imy-r k3t nbt nt nzwt, and then he was promoted to the vizierate and to the rank of a king's son, and was apparently permitted to use the tag n iti.f. Such a widening of the class of officials using this term suggests that b3-b3f be dated to the early fifth dynasty, when true king's sons were being removed from the civil administration, and older rules for the granting of titles and epithets were changing.

Suggested Date: Early fifth dynasty.

bb-ib; sndm-ib 43

Source: Tomb at North Saqqara, no. 11 (B 13).

Bibliography: PM 32, 451.

Relevant Titles: imy-r k3t.

Other Titles: wr md šm'w, rh nzwt, hq3 hwt-'3t, z3b hry-wdb.

Baer has dated this tomb to his period VB, although the low number of titles present in rankable sequences is not in itself decisive.¹ However, other indications tend to confirm this date. The chapel plan is cruciform, and it would not seem that this design continued much beyond the early fifth dynasty (Chapter 2.I.H). The false door has the distinctive features of wide apertures either side of the panel, the employment of only a single pair of jambs, and the wide niche with a figure of the owner surmounted by an inscription. The wide apertures are indicative of the late fourth to middle fifth dynasties (Chapter 2.I.D), and are not unlike those of w3š-ptḥ, of the reign of Neferirkare. This is also true of the jambs. The niche recalls those of the fourth dynasty, especially that of mry (58). These indications suggest the earlier fifth dynasty.

bb-ib may also appear in the reliefs of the mortuary temple of Neweserre.² This man holds the title of smr, which is not found in the Saqqara tomb. However the combination of the titles rh nzwt and smr is generally found only in titularies of the late fourth to early fifth dynasties,³ and so would not be out of place in this instance. Perhaps the title of smr was a promotion in the early part of the reign of Neweserre, about the time that the pyramid-

1 Reign of Neferirkare to middle that of Djedkare, Rank and Title, 69-70 (128).

2 Borchardt, Ne-user-re', Abb. 50.

3 For example, mry-ib (59), sš3t-ḥtp (126) and sšm-nfr I (129).

complex was being built, which would explain its non-appearance in the tomb which had already been constructed.

Suggested Date: Reign of Neferirkare to middle Neweserre.

pr-sn 44

Source: Mastaba in the far north-west corner of the Western Cemetery at Giza, LG 20.

Bibliography: PM 32, 48-9.

Relevant Titles: **imy-r k3t nbt nt nzwt.**

Other Titles: **wr md šm'w, rh nzwt, hrp hm-ntr, zš '-nzwt.**

From the arrangement and plan of the chapel of this tomb it has been placed above in a group with those of **sšm-nfr** I (129) and **k3i-pw-nzwt; k3i** (Chapter 2.II.C.1). These examples would seem to date from about the reign of Sahure to that of Neweserre, at which point another chapel type appeared. The title sequences are apparently typical of the period before the introduction of a ranking system,¹ which agrees with the other evidence for an early fifth dynasty date.

Suggested Date: Early fifth dynasty.

ph-n-wi-k3i 45

Source: Tomb at North Saqqara, D 70 (LS 15).

Bibliography: PM 32, 491-2.

Relevant Titles: **imy-r prwy-hd, imy-r zš ' nzwt, imy-r šnwty, imy-r k3t nbt nt nzwt, t3yty z3b t3ty.**

Other Titles: **imy-iz nhn, [imy-r] izwy mrt, imy-r izwy n pr hry-wdb, imy-r swt htpw df3w, imy-r gs-pr, mniw nhn, mdw rhyt, nst hntt, r p nb, h3ty-', hm-ntr hr qm3-', hm-ntr hqt, hry-sšt3 n wdt-mdw nbt nt nzwt, hq3 b3t, hrp wsh̄t, hrp zš iry sprw, ht h3, hry-tp nzwt, z3b 'd-mr, zš wr md šm'w, sh̄d w'b m w'b-swt-wsr-k3f, sd3wty bity.**

The tomb of **ph-n-wi-k3i** is one of the largest at Saqqara. It is generally dated to the middle of the fifth dynasty; for example, it is placed by Baer in his period VB.² Fischer has recently suggested, with a fair degree of certainty, that **špsi**, the owner of the nearby mastaba no. 73 (D 13),³ was the father of **ph-n-wi-k3i**, and it is actually quite probable that the latter was in fact mentioned in his tomb.⁴ The tomb of **špsi** is probably to be dated to the period preceding the introduction of a title-ranking system,

1 Baer, *Rank and Title*, 71-2 (143).

2 Reign of Neferirkare to middle Djedkare, *op. cit.*, 72 (146).

3 PM 32, 482.

4 JEA 65 (1979), 42-4.

presumably the early fifth dynasty.¹ The position of his tomb on the lower slopes of the mound surmounted by the mastaba of **ph-n-wi-k3i** is not unlike that of **ny-'nh-shmt**,² which can be independently dated to the reign of Sahure or slightly later. On this basis, the tomb of **špsi** may date to the reign of Neferirkare and the tomb of **ph-n-wi-k3i** about a generation later, perhaps in the later reign of Neweserre.

Suggested Date: Later reign of Neweserre

ph-r-nfr 46

Source: Tomb at North Saqqara, exact position unknown.

Bibliography: **PM** 32, 502.

Relevant Titles: **imy-r pr-hd**, **imy-r šnwt nbt nt nzwt**, **imy-r k3t nbt nt nzwt**.

Other Titles: **imy-r pr 'd**, **imy-r pr hry-wdb**, **imy-r pr-šn' 'fty hnt**, **imy-r pr-šn' 'fty t3-mhw**, **imy-r hwt m3t**, **imy-r hwt mhi**, **imy-r hwt ndt bi**, **imy-r hwt ndt ht3**, **imy-r hwt hmt**, **imy-r hwt šm't**, **iry-ht pr-hd**, **'d-mr imtt**, **'d-mr zt imtt**, **'d-mr tb ntrt**, **'d-mr dw3-hr-hnty-pt**, **wr md šm'w**, **wd-mdw n hry-wdb**, **wd'-mdw**, **rh nzwt**, **h3ty-' 'ndty**, **hm-ntr hr ini hwthr**, **hm-ntr hr hnty dmit**, **hm-ntr hqt**, **hm-ntr spd**, **hm-ntr sth hnty hry-wdb strt**, **hm-ntr dhwt**, **hq3 nzwt pr imtt**, **hq3 hwt-'3t bityw**, **hq3 hwt-'3t pr iwnw phr iwnw pr-iwnw**, **hq3 hwt-'3t r3-wr**, **hq3 hwt-'3t hwt ihwt**, **hq3 hwt-'3t hwt mrs-'nh**, **hq3 hwt-'3t hwt hk3**, **hq3 hwt-'3t hwt-sn**, **hrp i3rrwt**, **hrp brntw**, **hrp fsww**, **hrp rth**, **hrp zh**, **ht h3**, **hry sd3wty pr-hd**, **hry sdm**, **hry-tp nzwt**, **z3b nht-hrw ?**, **šhd iry-ht pr-hd**.

There are no published copies of the reliefs in this tomb, and thus one is left to date it solely on its inscriptions and plans. In these respects it is very reminiscent of the tomb of **mtn**, dated to the early fourth dynasty.³ Junker takes the **hwt mrs-'nh** in one of his titles to refer to the queen mentioned in an eighteenth dynasty inscription at Meydum in connection with Sneferu, who could have been that king's wife or mother.⁴ If this be true, **ph-r-nfr** was perhaps a contemporary of Sneferu or Khufu.

Suggested Date: Early fourth dynasty.

pth-htp d3r 47

Source: Tomb at North Saqqara, no. 41 (C 6).

Bibliography: **PM** 32, 462-3.

1 Baer, **Rank and Title**, 134-5 (489).

2 No. 74, **PM** 32, 482-3.

3 **PM** 32, 493-4.

4 **ZAS** 75 (1939), 63; inscription, Petrie, **Medum**, pl. XXXIII.

Relevant Titles: **imy-r hwt wrt 6, imy-r zš ' nzwt, imy-r k3t nbt nt nzwt, t3yty z3b t3ty.**
 Other Titles: **imy-r izwy hry htm md3t, imy-r izwy hkr nzwt, iry p't, h3ty-', hrp wsht.**

This tomb seems to have been built as a unit with that of **pth-htp** (48). Both were constructed against the outer wall of another mastaba, about which little is known. The date of these two tombs, both of viziers, may thus be discussed together; of the two, Mariette believed that of **pth-htp dšr** to be the older.¹

Baer dates both to his period VB.² The use of a cornice and torus on the false door of **pth-htp** (48) suggests that the piece is not earlier than the mid-fifth dynasty (Chapter 2.I.A). More importantly, the plan of these two chapels shows that between them they employed moderately complex chapels with east-west offering rooms, suggesting the middle to later fifth dynasty (Chapter 2.I.H).³ The plan of the chapel of **pth-htp dšr** is in many ways like that of **k3i-m-tntt** (146) of the reign of Djedkare.⁴ These features give a range of possible dates for the two **pth-htp** 's between the reigns of Neweserre and Djedkare.

There is a false door set against the outer wall of the mastaba onto which these two tombs were built. It is unsure as to which of them it belongs. Alternatively, it may have been dedicated to yet another vizier by the name of **pth-htp**, as advanced by Petrie.⁵ This individual is not included in this prosopography as the suggestion is far from certain. One would then have in these tombs a family complex for perhaps two generations, suggesting that **pth-htp dšr** and **pth-htp** (48) were brothers.

Suggested Date: Perhaps reign of Menkauhor or thereabouts.

pth-htp 48

Source: Tomb at North Saqqara, no. 42 (C 7).
 Bibliography: **PM 3², 463.**
 Relevant Titles: **imy-r prwy-hd, imy-r hwt wrt 6, imy-r zš ' nzwt, imy-r šnwty, imy-r k3t nbt nt nzwt, t3yty z3b t3ty.**
 Other Titles: **imy-r izwy mrt, imy-r izwy hry htm md3t, imy-r izwy hkr nzwt, imy-r wsht, iry p't, h3ty-'.**



- 1 **Mastabas, 123.**
- 2 **Reign of Neferirkare to middle reign of Djedkare; Rank and Title, 74 (158-9),** although he does add a query to this date.
- 3 **Both the plans of Mariette (op. cit., 124) and Murray (Saqqara Mastabas I, pl. XXXV) are incomplete; they are combined in PM 3², pl. XLVII (bottom right).**
- 4 **Mariette, op. cit., 187.**
- 5 **In Murray, op. cit., 5.**

The date of this tomb is discussed in the entry for pth-ḥtp dšr (47) above.

Suggested Date: Perhaps early reign of Djedkare.

pth-ḥtp 49 ('pth-ḥtp I')

Source: Tomb west of the Step Pyramid, Saqqara, D 62.

Bibliography: PM 32, 596-7.

Relevant Titles: imy-r prwy-ḥd, imy-r zš ' nzw, imy-r šnwty, imy-r k3t nbt nt nzw, t3yty z3b t3ty.

Other Titles: iwn knmwt, imy-r izwy hry ḥtm md3t, imy-r prwy-nwb, imy-r ḥt nbt nt nzw, imy-r hkr nzw, iry p't, mdw rhyt, r p nb, ḥ3ty-', hry-sšt3 n wdt-mdw nbt nt nzw, hry-sšt3 n nzw, hry-tp nḥb, hrp wsht, hry-ḥb, hry-ḥb hry-tp, zš md3t ntr, smr w'ty, smr w'ty n mrwt, smsw snwt, sd3wty bity.

In the same area as this tomb is that of the vizier 3ḥt-ḥtp (2), which contains a separate chapel for pth-ḥtp; tfi (50) (pth-ḥtp II); these individuals are believed to be this man's son and grandson. This affiliation is not explicitly stated in the tombs, but a son 3ḥt-ḥtp appears in the tomb of pth-ḥtp I with titles of hry-tp nzw and mdw rhyt.¹ Both titles are held by the vizier 3ḥt-ḥtp; though this in itself is but slender evidence for identifying him as the son of pth-ḥtp I, the similar location and scale of the tombs, as well as the high titles held by both, would support the deduction. The evidence for pth-ḥtp II being the son of 3ḥt-ḥtp is much stronger: apart from his chapel, the eldest son of 3ḥt-ḥtp is called pth-ḥtp and has the titles of imy-r niwt nfr-izzi, hry-tp nzw, mdw rhyt, z3b 'd-mr and z3b imy-r zš.² With the exception of the last, these titles all appear in the chapel of pth-ḥtp II. Common links between all three chapels are the high quality of the relief and the practice of ignoring the representation of the female members of the family.

The latest king mentioned in all three tombs is Djedkare.³ That three generations of the same family should have held their offices in one reign is unlikely, and so the most probable candidate for a date in the reign of Djedkare is pth-ḥtp I, who incidentally is the only one to possess a collection of estates of kings of the early fifth dynasty. The occurrence of royal names is not alone a safe criterion for dating, but this is the reason for Helck's date for pth-ḥtp I.⁴ Baer's system of title sequences place him in period VC with a leaning towards the later reign of Djedkare.⁵ The 'Maxims of Ptahhotep', the earliest copy of which, Papyrus Prisse,

1 Murray, *op. cit.*, pl. IX, XII.

2 Davies, *Ptahhetep and Akhethetep II*, pl. VI, IX.

3 pth-ḥtp I, in estate names; other tombs, in titles.

4 *Beamtentitel*, 138.

5 Middle Djedkare to middle Wenis, *Rank and Title*, 74-5 (160).

dates to the twelfth dynasty, are attributed in the text to a man of that name who served Djedkare as vizier,¹ and it is suggested by Helck (*loc. cit.*) and Baer (*loc. cit.*) that pth-htp I is the man who is supposed to have composed the original.

Suggested Date: Later reign of Djedkare.

pth-htp; tfi 50 ('pth-htp II')

Son of 3ht-htp (2).

Source: Chapel in the tomb of his father, west of the Step Pyramid at Saqqara, D 64.

Bibliography: PM 32, 600-4

Relevant Titles: 1. Before Vizierate: imy-r hwt wrt.
2. When Vizier: t3ty z3b t3ty.

Other Titles: 1. Before Vizierate: iwn knmwt, imy-r niwt mn-swt-ny-wsr-r', imy-r niwt nfr-dd-k3-r', imy-r niwt ntr-swt-mn-k3w-hr, imy-r sm'w, imy-r gs-pr, wd-mdw, wd-mdw n hry-wdb, mdw rhyt, nst hntt, hm-ntr m3't, hm-ntr hqt, hry-sst3 wdt-mdw [s]t3t nt nzwt, hry-sst3 n wdt-mdw nbt nt nzwt, hrp wr md sm'w, hrp wsht, hrp zš iry sprw, hrp qqw, ht h3, hry-tp nzwt, z3b 'd-mr, shd w'b mn-swt-ny-wsr-r', shd hm-ntr nfr-dd-k3-r', shd hm-ntr ntr-swt-mn-k3w-hr.

2. When Vizier: imy-r ///.²

The family relationships are discussed above under pth-htp I (49). The title sequences of pth-htp II fit Baer's period VD, the same as those of his father.³ That there was less than a generation separating father and son in their tenures of the vizierate is suggested by the appearance of the granary official k3i-hp in this tomb and that of his grandfather pth-htp I, showing that these perhaps built their tombs in the lifetime of one official.⁴ It is probable that the pre-vizierial titulary of pth-htp II consisted of the titles he held while 3ht-htp was alive, and he was promoted to the vizierate at some point after the latter's death in the later reign of Wenis.

Suggested Date: Late reign of Wenis (as vizier).

- 1 In this text he is given the titles of iry p't, h3ty-', iti ntr, mry ntr, sdm m hwt wrt 6, iry shr m t3 r dr.f, imy-r niwt, t3ty (Zaba, *Les Maximes de Ptahhotep*, 15 (2-4)). These are clearly of a Middle Kingdom nature, and doubtless reflect the titulary of a vizier of that time.
- 2 His vizierial titulary is clearly incomplete, and is only found on the sarcophagus, an important part of which, from the point of view of titles, has been damaged. It does however permit his titulary to be divided as above.
- 3 Middle reign of Wenis to early Teti, *Rank and Title*, 75 (161).
- 4 Tomb of pth-htp I: Murray, *Saqqara Mastabas I*, pl. XIV (3).
Tomb of pth-htp II: Paget-Pirie, *Ptah-hetep*, pl. XXXI, XXXIV.

pth-htp 51

- Source: Tomb about 200 metres south of the pyramid of Wenis at Saqqara, LS 31.
- Bibliography: PM 3², 653-4.
- Relevant Titles: imy-r prwy-hd, imy-r hwt wrt 6, imy-r zš ' nzw, imy-r šnwt, t3yty z3b t3ty.
- Other Titles: imy-r w'bt, [imy-r] prwy nwb, imy-r hkr nzw, hrp wsht.

This tomb is the sole Old Kingdom example found to date in this area. The chapel plan is very complex, with a pillared court and rooms leading off to the west and south, most of which have been left undecorated. This plan has no close parallel, but is reminiscent of the tombs of 3ht-htp; hmi (3), k3i-gmni; mmi (151) and mh_w (69), which suggest a date no earlier than the late fifth dynasty. It would seem that the viziers of Wenis, Teti and the later reign of Pepy II were buried near the pyramids of their kings, but that the known viziers of the reigns of Pepy I and Merenre were not (compare idw I; nfr (22) above). It is to this period that this tomb perhaps belongs, probably only a little later than the owners of other large tombs, such as mh_w and hnty-k3i; ihhi (109).

Suggested Date: Perhaps first half of the reign of Pepy I.

pth-špss 52

- Source: Tomb at the north-east corner of the funerary complex of Neweserre at Abusir.
- Bibliography: PM 3², 340-2; some further information, Verner, *Acts 1st ICE*, 671-5; Žaba, *Preliminary Report on Czechoslovak Excavations in the Mastaba of Ptahshepses at Abusir, passim*.
- Relevant Titles: imy-r k3t nbt nt nzw, t3yty z3b t3ty.
- Other Titles: imy-iz nhn, imy-r izwy hkr nzw, imy-r w'bt, iry nfr-h3t, '3 dw3w, mniw nhn, h3ty-', hm st, hm-ntr nhbt nbt 'h-ntr šm'w, hry-sšt3 n pr-dw3t, hry-sšt3
n mdw št3 n mdw ntr, hry-tp nhb, ht , hry-hb, hry-hb hry-tp, smr w'ty, z3 nzw.

This tomb is one of the largest known in Egypt, and its great size is possibly due to the relationship of its owner to Neweserre. He married a daughter of that king by the name of h'-mrr-nbty,¹ and several features of the tomb may have come about as the direct result of the favour shown by the king to his son-in-law, for example the boat pits and the design of the burial chamber.² Helck

1 Verner, *op. cit.*, 674; her titles are given by de Morgan, *RA Ser 3* 24 (1894), 32.
2 Verner, *op. cit.*, 672.

has identified **pth-špss** with the official of the same name who bears the title of **smr w'ty** in the reliefs of the mortuary temples of Sahure, Neferirkare and Neweserre at Abusir.¹ However, as Baer has noted, the name is common in the middle of the fifth dynasty, and it need not be the owner of the tomb at Abusir,² although this is not to say that some examples, especially the later ones, could not refer to this man. The only close parallel to the plan of the offering chapel of his tomb is that of **r'-špss** (95) at Saqqara, dated to the reign of Djedkare, and it is possible that the two were to some extent contemporary.

Suggested Date: End of the reign of Neweserre to early Djedkare (?).

pth-špss 53

Source: Tomb north of the mastaba of **k3i-gmni** (151) in the Teti pyramid cemetery at Saqqara.

Bibliography: **PM** 3², 518; almost completely unpublished - most information from personal examination of tomb.

Relevant Titles: **imy-r prwy-hd**.

Other Titles: **imy-r šwy pr-'3**, **iry nfr-h3t**, **h3ty-'**, **hry-hb**, **smr w'ty**, **shd hm-ntr dd-swt-tti**.

This small chapel is one of the group of those situated to the north of the great mastabas in the cemetery. It is likely that this group dates to the reign of Pepy I or slightly later (see below, **mrw** (64)). The chapel of **pth-špss** differs from the others in that the decoration on the walls is painted on brick; the poorer nature of this work may place the tomb at a later date than the others.

Suggested Date: Late reign of Pepy I or later.

pth-špss; impy 53a

Source: Seated statue, Louvre A108 (= N113), provenance unknown.

Bibliography: None - to be published in a catalogue of Louvre Statuary by Ziegler.

Relevant Titles: **imy-r k3t nbt nt nzwt**.

Other Titles: **wr hrp hmwt**, **wr hrp hmwt hrw n hb**, **hry-hb**, **smr w'ty**.

1 **Beamtentitel**, 136, with references.

2 **Rank and Title**, 76 (167). However, Baer's subsequent assignation of this tomb to his period VD is a problem (middle reign of Djedkare to middle Wenis), but the above evidence is perhaps sufficient for it to be disregarded.

Although the provenance of this statue is unknown, such sequences of titles, particularly those of **wr hrp hmwt**, the High Priest of Ptah at Memphis, are found only at Saqqara in the Old Kingdom, and we can be well-nigh sure that the tomb of this official was at that site.

Freier believes that the titles of **pth-špss** date him later than the **wr hrp hmwt s3bw; tti**, who is usually dated to the middle of the sixth dynasty or later.¹ The modelling of the facial features of this statue is not of the standard of the best work of the fifth or early sixth dynasties, but has something in common with several examples later than that period.²

Suggested Date: After the middle of the sixth dynasty.

m3-nfr 54

Source: Tomb at North Saqqara, no. 26 (D 37).

Bibliography: **PM** 32, 456-7.

Relevant Titles: **imy-r zš ' nzwt**.

Other Titles: **iwn knmwt, imy-r izwy pr md3t, imy-r izwy pr hry-wdb, imy-r izwy hry htm md3t, wr md šm'w, wd wd'-mdw n hry-wdb, mdw rhyt, nst hntt, hm-ntr m3't, hm-ntr hr qm3-', hry-sšt3 n wdt-mdw nbt nt nzwt, hry-sšt3 n md3t nbt nt nzwt, hrp wsht, hrp zš iry sprw, hrp zš pr hry-wdb, hrp zš nb, hry-tp nzwt, z3b 'd-mr, zš wr md šm'w.**

This tomb seems to consist in its entirety of a false door set in a brick niche, built against an older mastaba. No information is available about this earlier construction. Baer dates the tomb of **m3-nfr** to his period VIF.³ However, there are some features of the false door which might date it to an earlier period, notably the wide apertures either side of the panel, very much a fifth dynasty characteristic; the even length of the jambs, in conjunction with the lack of cornice and torus, suggest perhaps a date in the later fifth dynasty (Ch 2.I.A, B and D). It would appear that, on further investigation, although the date Baer gives on the basis of the archaeological sources is very vague, he has used the title sequences of **m3-nfr** for no apparent reason as the base chart for his period VIF.⁴ It may thus be said that the attribution to period VIF is arbitrary; in fact the title sequences also fit period VC (middle reign of Djedkare to middle Wenis), closer to the date suggested by the form of the false door.

1 **Altorientalische Forschungen** 4 (1976), 11; for **s3bw; tti** see Baer, Rank and Tittle, 121 (422).

2 For example, Cairo, **CG** 120 and 172, the latter being late Old Kingdom; also the statues of **idi**, Fischer, **AJA** 66 (1962), 65-6, pl. 17-8.

3 Middle reign of Pepy II, *op. cit.*, 77 (171).

4 *op. cit.*, 224.

The father of this man is said to be **sh̄m-k3i**, on the basis of Louvre statue A104 (N110, E3031).¹ His tomb exhibits a door of not dissimilar style to that of **m3-nfr** and his chapel is 'L'-shaped, as one might expect of an official who would date to the mid-fifth dynasty if the dating of **m3-nfr** is correct.

Suggested Date: Later fifth dynasty.

minw-nfr 55

Sources and Bibliography: 1. Depicted among officials in the mortuary temple of Neweserre at Abusir: Borchardt, **Ne-user-re'**, Abb. 51c, 52a, cf. pp. 73 (31, 45,1), 74 (47,3).
 2. Named in a quarry-mark on the limestone wall forming the boundary of the pyramid complex of Neferirkare: **id.**, **Nefer-ir-ke3-re'**, 53, Abb. 61.
 3. A body of his mortuary priests appears in the Abusir Papyri in connection with the mortuary temple of Neferirkare, Posener-Kriéger, **ArchAb** II, 590.
 4. A sarcophagus in Leiden, Rijksmuseum Inv. AMT. 106: **PM** 32, 764.

Relevant Titles: **imy-r k3t nbt nt nzwt, t3yty z3b t3ty.**

Other Titles: **hm-ntr inpw nb z3wt imy wt, hry-hb.**

No tomb has yet been found for this man. Porter and Moss suggest tomb F 3 at Saqqara;² however this **minw-nfr** is only a **smsw pr**, not a title attested at all among those of viziers, and such an identification would seem inherently improbable.

The exact location of the reliefs in the temple of Neweserre featuring **minw-nfr** is not known, making it difficult to conclude in which stage of the temple's construction they were cut. In the nearby temple of Sahure, many of the depictions of officials belong to the end of that king's reign (see above, **wr-b3w-b3** (39)). The problem with drawing an analogy is that the length of the reign of Neweserre is not known; it is however unlikely that these reliefs would have been cut before year ten of his reign. **minw-nfr** may already have been vizier near the beginning of the reign, when the temple of Neferirkare was being completed by Neweserre.

Suggested Date: Early to middle reign of Neweserre.

mn-'nh-ppy; mni 56

Source: An alabaster offering table, from the so-called 'Greek Serapeum' area at Saqqara, Cairo, JE 38427.

1 **PM** 32, 465-6 (tomb no. 54 (C 19)).
 2 **PM** 32, 337; for F 3 see **PM** 32, 586.

Bibliography: PM 32, 565; Cairo, CG 57014; Mostafa, *Opfertafel*, Taf. XXXV.

Relevant Titles: imy-r šnwt_y.

Other Titles: imy-r hm-ntr, hry-hb, smr w'ty.

This piece cannot be earlier than the reign of Pepy II due to the employment of part of the name of his pyramid; comparable offering tables are found from the end of the sixth dynasty.¹ By comparing the sequence of titles with Baer's lists for the reign of Pepy II, the only ones that fit are VIC (early) and VIE (middle). As most of the memphite monuments of individuals contemporary with Pepy II come from South Saqqara, it is possible that this one may date to the period after his death when the Teti pyramid cemetery regained the pre-eminence it held early in the sixth dynasty (compare the discussions below of šdy-ptḥ (134) and ttw (160)).

Suggested Date: Late Old Kingdom or later.

mri; idw 57

Source: A false door, British Museum 1191, exact provenance unknown, but probably from Saqqara.

Bibliography: PM 32, 742.

Relevant Titles: imy-r hwt wrt 6.

Other Titles: iwn knmwt, mdw rhyt, hm-ntr m3't, hry-tp nzwt, hry-tp nzwt m3', z3b 'd-mr, zš '-nzwt.

Several features of this false door would suggest a date not early in the Old Kingdom, perhaps the most important of which is the appearance of a pair of wd3t eyes on the rear of the central niche. No exact Old Kingdom parallels to this are to be found, but such eyes do appear on early Middle Kingdom stelae, and on the false door of ihy from Saqqara (reign of Amenemhat I).² There is also the somewhat crude style of the piece, emphasised by the elongated figures. Baer would allow all periods of the sixth dynasty as well as a late date to be possible.³

Suggested Date: Late sixth dynasty to First Intermediate Period.

mry 58

Source: Tomb probably from North Saqqara, exact position unknown. The blocks are dispersed over a number of collections.

Bibliography: PM 32, 501-2.

Relevant Titles: imy-r pr-hd.

1 Mostafa, *op. cit.*, 130 with examples in note 4.

2 Firth-Gunn, *Teti Pyramid Cemeteries II*, pl. 83.

3 *Rank and Title*, 79 (181).

Other Titles: imy-r iz n hkr nzwt, imy-r pr 'h3w, imy-r zš md3t
 '-nzwt, mdh zš nzwt, mdh , rh nzwt, hm-ntr
 rnnwtt, hm-ntr hrwy imy-ti, hry-sšt3 pr-'3, smr,
 smr w'ty.

The style of the workmanship of this tomb is compared by Smith to that of šry, and he dates both to the middle of the fourth dynasty,¹ which is followed by Baer.² The deep niche and probable cruciform plan of the chapel of mry continue the tradition of examples which belong to the late third to early fourth dynasties. An offering list is found on the panel but no linen list, and it is a reasonable assumption that the disappearance of the latter was a development of the later fourth dynasty (Chapter 2.I.G.1)

Suggested Date: Middle to late fourth dynasty.

mry-ib 59

Source: Tomb in the Western Cemetery at Giza, G2100-I-annexe; chapel now in East Berlin, 1107.

Bibliography: PM 32, 71-2.

Relevant Titles: imy-r k3t nbt nt nzwt.

Other Titles: imy-r mš', 'd-mr imw, wr m3 iwnw, wr md šm'w, wty
 inpw, r p nb, rh nzwt, hm-ntr hwfsw, hrp 'h, hts
 inpw, hry-hb, z3 nzwt, z3 nzwt n ht.f, smr, smr
 w'ty, shd b3-ntrw, sd3wty ntr imw, sd3wty ntr b3-ntrw, sd3wty ntr
 b'-ntrw, sd3wty ntr n b3-ntrw dw3-t3wy, sd3wty ntr n nb rhyt,
 sd3wty ntr n dw3-t3wy.³

The tomb of mry-ib is to some extent related to the neighbouring one of nfr (84) (G2110), at least in respect of the arrangement of the panel of the false door. The tomb of mry-ib was one of the first to employ a two-door chapel design and also to adopt the arrangement of the deceased standing between the doors facing south (Chapter 2.II.C.1). It is thus perhaps to be dated to the reign of Menkaure or the end of the fourth dynasty.

Suggested Date: Menkaure to end of the fourth dynasty.

mry-ptḥ-mry-r' 60

Source: One of the addressees of the Dahshur decree of Pepy I.

1 AJA 46 (1942), 515; tomb of šry, PM 32, 490 (B3).

2 Rank and Title, 78-9 (180).

3 Those of z3 nzwt and shd b3-ntrw are included from the probable equation of mry-ib with k3i-pw-nzwt the father of nn-sdr-k3i, shown in Junker, Giza II, Abb. 8b.

Bibliography: For the decree, PM 32, 876.

Relevant Titles: imy-r k3t.

Other Titles: No others given.

This decree is dated to the year of the twenty-first cattle-count of the reign of Pepy I. Due to the uncertain length of the reign, the exact time-point of the decree is uncertain, but it can hardly be the earlier part.

The surviving names and titles of the leading recipients of the decree may be interpreted in more than one way. The following remains of the first line: /// nzwṯ /// t3yṯy z3b t3ty /// imy-r k3t mry-ptḥ-mry-r'. Helck has reconstructed this line as iry p't, sdt nzwṯ, ḥ3ty-', imy-r niwt mr, t3yṯy z3b t3ty imy-r k3t mry-ptḥ-mry-r'.¹ It is unlikely that the t3ty group was written

 as Helck would believe, since this title is not written in

this manner until after the Old Kingdom (see below page 304-6). It is more probable that a short name has been erased, perhaps that of r'-wr (93), leaving mry-ptḥ-mry-r' with the title of imy-r k3t only.

Suggested Date: Late reign of Pepy I.

mry-r'-i3m 61

Source: Tomb east of the pyramid complex of Pepy II at South Saqqara, M. 13.

Bibliography: PM 32, 683.

Relevant Titles: t3yṯy z3b t3ty.

Other Titles: imy-r niwt mr, iry p't, iry p't m3', ḥ3ty-', ḥq3 ḥwt, ḥrp šndyt nbt.

Kees, in his discussion of the viziers of Pepy II, quotes an opinion of Jéquier's (possibly from a private communication) to the effect that the tomb of mry-r'-i3m is the oldest of its group.² The tomb is dated by Baer to periods VIC-E, approximately the time of the construction of the pyramid temple.³ A man by the name of ppy-i3m appears twice in the mortuary temple of Pepy II.⁴ The first of these occurrences is the more important, as he is there given the titles of sd3wṯy bity, smr w'ty and hry-ḥb, and he is shown as one of the line of officials headed by the vizier idi. mry-r'-i3m does not possess all of these titles in his tomb inscriptions, although their restoration in the damaged portions need not present a problem as they are commonly found in the tombs of

1 *Beamtentitel*, 140.

2 *Veziat*, 45.

3 Merenre to year fifty-five of Pepy II, *Rank and Title*, 79-80 (184).

4 Jéquier, *Pepi II II*, pl. 48, 71.

other high officials buried in this cemetery. Against this identification should be placed the relative frequency of this name at this period. However, if this be accepted, then he was vizier later than *idi*, and combining this with the evidence of the date of his tomb given above, it would seem that his vizierate postdates the temple by only a little, and thus dates perhaps to some time in the second quarter of the reign.

Suggested Date: Later first half of the reign of Pepy II.

mry-r'-mry-'nh-ptḥ; ptḥ-špss; impy 62 ('impy')

Son of nhbw (90)

Sources and Bibliography: 1. Depicted among the officials in the mortuary temple of Pepy II at South Saqqara: Jéquier, *Pepi II II*, pl. 48; perhaps also *id.*, *op. cit.* III, pl. 35 (bottom right).

2. Burial in shaft G2381a in the Western Cemetery at Giza, *PM* 3², 91-2; also a few blocks remaining from chapel: for some details, Brovanski, *L'Égyptologie en 1979 II*, 118; further information from excavation records in Boston.

Relevant Titles: 1. Before Vizierate: imy-r k3t nbt.

2. When Vizier: imy-r zš ' nzwt, imy-r k3t nbt nt nzwt, t3yty z3b t3ty.

Other Titles: 1. Before Vizierate: mdḥ qd nzwt m prwy.

2. When Vizier: im3-' , imy-r w'btty, imy-r niwt, mdḥ qd nzwt m prwy, h3ty-' , hrp šndyt nbt, hry-hb hry-tp, sm, smr w'ty, sd3wty bity.

The decoration of the part of the temple in which *impy* appears seems to have been completed around years twenty to thirty of the reign (above, *ihy-hnt* (16)). He may thus have been promoted to the vizierate in the middle of the reign, probably after he had begun his tomb, as the title of *t3yty z3b t3ty* is only found on blocks from the serdab. Baer dates him after the end of the Old Kingdom, although he attempts to explain the apparent contradiction.¹

The burial of *impy* is unusual in that the coffin seems to be inscribed for two people, himself and *s3bw-ptḥ; ibbi* (117). *s3bw-ptḥ* is shown as a son of *nhbw* in the latter's tomb,² while *impy* is assumed to be a son of *nhbw* on the similarity of their names and also his appearance in that official's Wadi Hammamat inscriptions.³ It would seem that the differences in the titularies on the coffin preclude them from referring to the same man, especially as that person would then have five names. Only one burial was effected in

1 Rank and Title, 96, 292 (286a).

2 Smith, *BMA* 56 (1958), 59, fig. 2.

3 *Urk.* I, 93.9; Goyon, *Nouvelles inscriptions rupestres du Wadi Hammamat*, no. 21.

the tomb, but the identity is difficult to establish: the name of **impy** is the more prominent, but that of **s3bw-ptḥ** appears on the headrest. One wonders whether this is an unusual case of a man known by a great many names.

Suggested Date: Just before the middle of the reign of Pepy II.

mry-tti 63

Son of **mrrw-k3i**; **mri** (68)

Source: Chapel in the tomb of his father in the Teti pyramid cemetery, Saqqara.

Bibliography: **PM** 32, 536; also personal examination of tomb.

Relevant Titles: **imy-r hwt wrt 6**, **imy-r zš ' nzw**t, **imy-r k3t nbt nt nzw**t, **t3yty z3b t3ty**.

Other Titles: **im3-**, **imy-iz nḥn**, **imy-r izwy hkr nzw**t, **imy-r 'ḥ-ntr šm'w**, **iry p't**, **'3 dw3w**, **' nmty**, **' hq3t**, **'d-mr dw3-ḥr-hnty-pt**, **'d-mr dp**, **wty inpw**, **mnw nḥn**, **mdw ḥp**, **r p nb**, **h3ty-**, **ḥm-ntr mn-nfr-mry-r' ppy**, **ḥm-ntr nḥbt**, **ḥm-ntr ḥr inpw hnty pr smswt**, **ḥm-ntr ḥr ḥry-ib 'ḥ-ntr**, **ḥry wrw**, **ḥry-sšt3 n pr-dw3t**, **ḥry-sšt3 n m33t w'**, **ḥry-sšt3 nzw**t **m swt.f nbt**, **ḥry-tp nḥb**, **ḥts inpw**, **hnty-š mn-nfr-mry-r' ppy**, **hnty-š dd-sw**t-tti, **ḥrp i3t nbt nḥrt**, **ḥrp ibt**, **ḥrp m nḥrw**, **ḥrp nsty**, **ḥrp ḥwwt nt**, **ḥrp šndyt nbt**, **ḥry-ḥb n iti.f**, **ḥry-ḥb ḥry-tp**, **z3 nzw**t, **zš md3t ntr**, **sm**, **sm3 minw**, **smr w'ty**, **smsw snwt**, **shd ḥm-ntr mn-nfr-mry-r' ppy**, **shd ḥm-ntr dd-sw**t-tti, **sd3wty bity**, **sd3wty ntr m imwwy '3**.

In his important contribution to the study of this chapel, Nims dates it to the reign of Pepy I on the basis of the titles incorporating the name of that king's pyramid and also the sequence of usurpations of the inscriptions; he shows that the decoration was cut later than that of **mrrw-k3i**.¹ Baer dates this chapel to his period VIC, one period later than that of **mrrw-k3i**, which supports the conclusions of Nims, and points to the middle of the reign as a date.²

Suggested Date: Middle reign of Pepy I.

mry; **tti-snb**; **mry-r'-snb** (**ppy-snb**) 64

Source: Tomb immediately to the north of that of **mrrw-k3i** (68) in the Teti pyramid cemetery at Saqqara.

Bibliography: **PM** 32, 520; also personal examination of tomb.

Relevant Titles: **imy-r snwt nbt**.

1 **JAOS** 58 (1938), 638-47.

2 Merenre to early Pepy II, **Rank and Title**, 80-1 (189)

Other Titles: imy-r wpt dd-swt-tti, imy-r hwt ihwt, imy-r hnty-š pr-'3, imy-r hnty-š dd-swt-tti, imy-r sqbbwy pr-'3, imy-r špss nzwt, imy-r šn-t3 nb, imy-r ddt pt qm3t t3, imy-ht hm-ntr mrt tti, h3ty-', hnty-š dd-swt-tti, hrp šndyt nbt, hry-hb, hry-hb hry-tp, zš hry-tp d3t, sm, smr w'ty, shd hm-ntr dd-swt-tti, špss nzwt.

mrw, whose (presumably) original rn-nfr was tti-snb, acquired the additional name of mry-r'-snb, an alteration for which the likeliest explanation is that he lived in the reigns of both Teti and Pepy I, commencing his tomb in the former reign and completing it in the latter. He may not have lived beyond the middle of the reign of Pepy I.

Suggested Date: Early to middle reign of Pepy I.

mrw-k3i 65

Source: Tomb at North Saqqara, no. 77 (D 9).
 Bibliography: PM 32, 484.
 Relevant Titles: imy-r zš ' nzwt n wdt-mdw nbt nt nzwt, imy-r zš ' nzwt n k3t nbt nt nzwt.
 Other Titles: Apparently none.

Next to nothing is known about this tomb. It is located near both fifth (ph-n-wi-k3i (45)) and sixth dynasty (tp-m-'nh (155)) tombs. The fragment of the false door found by Mariette has three vertical columns of text, possibly suggesting wide jambs of the older type of false door without torus and cornice (Chapter 2.I.B). A date not late in the fifth dynasty is possible but by no means certain.

Suggested Date: Perhaps middle fifth dynasty (?).

mrri 66

Source: Tomb to the north of the mastaba of mrrw-k3i (68) in the Teti pyramid cemetery at Saqqara.
 Bibliography: PM 32, 518-9; also personal examination of tomb. See now Davies et al., Saqqara Tombs I, 2-20.
 Relevant Titles: imy-r prwy-hd.
 Other Titles: imy-r izwy hkr nzwt, imy-r w'bty, imy-r wnt prw, imy-r prwy-nwb, imy-r hnty-š, imy-r hnty-š pr-'3, imy-r ht nbt ddt pt qm3t t3, imy-r sqbbwy pr-'3, imy-r st hnty-š pr-'3, imy-r šwy pr-'3, mniw nhn, h3ty-', hry-sšt3, hry-sšt3 n pr-dw3t, hry-tp nhb, hry-hb, hry-tp nzwt, hry-tp nzwt pr-'3, smr w'ty, smr pr.

Of the small mastabas in this part of the Teti pyramid cemetery, only that of mrw (64) may be given a reasonably sure date, and it seems likely that most of this group date to a roughly similar period, perhaps the reign of Pepy I or a little later, postdating the great mastabas in this cemetery by only a few years; the tomb

of mrrī may be one of the earliest ones.¹

Suggested Date: Perhaps early to middle reign of Pepy I.

mrrī 67

Source: Tomb west of the Step Pyramid at Saqqara, adjoining the east wall of the tomb of pth-htp I (49).

Bibliography: PM 3², 607-8; also personal examination of chapel.

Relevant Titles: imy-r prwy-ḥd, imy-r hwt wrt 6, imy-r zš 'nzwt, imy-r šnwty, imy-r k3t nbt nt nzwt, t3yty z3b t3ty.

Other Titles: im3-', imy-r izwy n hkr nzwt, imy-r niwt mr, imy-r swt špswt pr-'3, imy-r sđmt nbt, imy-r šm'w, iry p't, mdḥ nzwt m qd m prwy, mdḥ zš' nzwt, ḥ3ty-', hry-ḥb hry-tp, smr w'ty, sd3wty bity.

This tomb is not discussed by Baer, but the title sequences would appear to date it to his periods VIB or D (later reign of Teti to later Pepy I, and early to middle reign of Pepy II). The arrangement of the false door has affinities with examples from the reign of Pepy I (for example, mḥw (69)), but bears no resemblance to those from the reign of Pepy II at South Saqqara.

In this tomb were found several blocks reused as paving, one bearing the Horus name of Teti and another the title shd ḥm-ntr dd-swt-tti.² Hassan suggests that these may come from the Teti pyramid temple and the associated cemetery, and he argues that such removal would not have taken place for several years after the death of Teti.³ Kanawati is of the opinion that the paving stones may be 'unwanted slabs';⁴ it would however seem unlikely that these blocks were carved and then not included in the decoration, as the common practice was for the blocks to be given their final dressing and to be carved after they had been set in place.⁵ A problem with Hassan's theory is that the funerary cult of Teti seems to have continued at least until the twelfth dynasty, and one would perhaps not expect blocks to be removed while the cult was still active.⁶ These blocks present a serious problem, but if they were indeed removed from the Teti cemetery, this was unlikely to have happened before the end of the reign of Pepy I; as most of the tombs of officials from the middle of the reign of Pepy II are at South Saqqara, mrrī should perhaps be dated to the period preceding the establishment of that cemetery.

1 Davies et al., *op. cit.*, 1; Baer's date of periods VIB-G (later reign of Teti to later Pepy II) is in agreement with this (*Rank and Title*, 82 (195)).

2 Hassan, *Saqqara III*, pl. XXIII (A).

3 *op. cit.*, 27.

4 *Governmental Reforms*, 34.

5 Clarke-Engelbach, *Ancient Egyptian Masonry*, 100.

6 Helck, *MDAIK* 15 (1957), 110.

Suggested Date: Perhaps reign of Merenre to early reign of Pepy II.

mrrw-k3i; mri 68

Source: Tomb in the Teti pyramid cemetery, Saqqara.
 Bibliography: PM 32, 525-35; also personal examination of tomb.
 Relevant Titles: imy-r prwy-hd, imy-r hwt wrt 6, imy-r zš 'nzw, imy-r šnwty, imy-r k3t nbt nt nzwt, t3tyt z3b t3tyt¹
 Other Titles: im3-', imy-iz, imy-iz nhn, imy-r ipt nzwt, imy-r izwy hkr nzwt, imy-r 'h-ntr šm'w, imy-r w'bt, imy-r hkr nzwt nb, imy-r pr h3w, imy-r pr phrt, imy-r prwy-nwb, imy-r hkr nzwt nb, imy-r swt špswt pr-'3, imy-r shty htp, imy-r sqbbwy pr-'3, imy-r stp-z3 pr-nzw nb, imy-r gswy imw n zwnw pr-'3, imy-r ddt pt qm3t t3, iry p't, '3 dw3w, ' nnty, ' hq3t, 'd-mr dw3-hr-hnty-pt, 'd-mr dp, w' wr hb, wr idt, wr m3, wr m3 m prwy, wr hry-hb hry-tp, wr 5 m pr-dhwty, wty inpw, wd-mdw n srw, mniw nhn, mdw hp, mdw h3zt, r p nb, h3ty-', hm b3w p, hm b3w nhn, hm-ntr hr imy šnt, hry wpwt št3t pr-'3, hry wrw, hry nws n w3dt, hry-sšt3, hry-sšt3 ///, hry-sšt3 n wd'-mdw n hwt wrt 6, hry-sšt3 n wdt-mdw nbt nt nzwt, hry-sšt3 n pr-dw3t, hry-sšt3 n m33t w', hry-sšt3 n mdw ntr, hry-sšt3 n št3w pt, hry-sšt3 nzwt m swt.f nbt, hry-tp nhb, hq3 b3t, hts inpw, hw-', hnty-š dd-swt-tti, hrp i3t nbt ntrt, hrp i3ts km, hrp ibt hr, hrp m ntrw, hrp nsty, hrp hwwt mw, hrp hwwt nt, hrp smsw hr, hrp šndyt nbt, hry-hb, hry-hb hry-tp, zš md3t ntr, sm, sm3 inpw, sm3 minw, sm3 hr, smr w'ty, smsw snwt, šhd hm-ntr dd-swt-tti, sd3wty bity, sdt nzwt.

The date of this and the other major tombs in this cemetery is well-established as principally the reign of Teti, with those of hnty-k3i (109) and nfr-sšm-ptḥ (87) belonging partly to the reign of Pepy I. There is some uncertainty as to the relative dates of mrrw-k3i, k3i-gmni (151), nfr-sšm-r' (88) and 'nh-m-'-hr (30).

Firth placed these tombs in the order nfr-sšm-r', k3i-gmni, mrrw-k3i, without mentioning 'nh-m-'-hr,² according to the increasing amount of decoration above and below ground and the number of rooms. This view has not received the attention it deserves. k3i-gmni is often considered the oldest of the group, for example, by Baer, who places him at the beginning of the reign of Teti, while dating the remainder to the period beginning in the middle of the reign of Teti (VIB). mrrw-k3i, by virtue of the position of his tomb, is often regarded as a contemporary of k3i-gmni.³ Although the blocks forming the outer western wall of the mastaba of k3i-gmni have been adapted for use in the adjoining wall of the

1 The titles of imy-r šnwty and imy-r prwy-hd seem only to occur on the outer temenos wall of the mastaba, and may thus have been granted to him later than the others which are found inside the tomb itself.

2 Teti Pyramid Cemeteries I, 15.

3 For example, Kanawati, Governmental Reforms, 25.

tomb of mrrw-k3i, the batter applied to the former wall suggests that the two were not built, or at least originally conceived, as a unit.¹ That the tomb of mrrw-k3i was constructed separately from and later than that of k3i-gmni would explain the unusual location of the entrance of the former on the south side, perhaps implying that the best sites in the cemetery had already been taken. It is possible that these more favourable locations had already been used for the tombs of nfr-sšm-r' and 'nh-m'-hr. The plans of their tombs are more closely related to that of k3i-gmni than that of mrrw-k3i; the plan of the latter has in fact more affinities with the tomb of hnty-k3i, undoubtedly built at least partly in the reign of Pepy I. Further associations between the two latter tombs may be noted in the quality of the relief: parts of the tomb of mrrw-k3i are cut in a rather rough manner as is most of the tomb of hnty-k3i, and all of the chapel of mrrw-k3i's son mry-tti (63); only very small areas of that of 'nh-m'-hr are in the same style. It would seem that this is indicative of the very end of the reign of Teti and that of Pepy I.

One may then perhaps order these four tombs as k3i-gmni, nfr-sšm-r' (this could be reversed), 'nh-m'-hr and mrrw-k3i, with that of the latter still being built at the end of the reign of Teti or even the very beginning of that of Pepy I.

Suggested Date: End of the reign of Teti.

mhw 69

- Source: Tomb in the Wenis Cemetery at Saqqara, immediately south of the Temenos Wall of the Step Pyramid.
- Bibliography: PM 32, 619-22; unpublished - personal examination of tomb.
- Relevant Titles: imy-r prwy-hd, imy-r hwt wrt, imy-r hwt wrt 6, imy-r zš 'nzwt, imy-r šnwty, t3yty z3b t3ty.
- Other Titles: iwn knmw, im3-, imy-r imw, imy-r imw gb, imy-r izwy hkr nzwt, imy-r w'bt, imy-r wpt m prwy, imy-r wdt-mdw nbt nt nzwt, imy-r prwy-nwb, imy-r niwwt, imy-r niwwt m3wt, imy-r zš hry htm md3t, imy-r sdmt nbt, imy-r šm'w, imy-r gs-pr, imy-r gswy-pr, imy-r gswy-pr m3', imy-r gswy-pr m3' m3', iry p't, iry nfr-h3t, mdw rhyt, mdw hp, h3ty-, hry-sšt3, hry-sšt3 n wdt-mdw nbt nt nzwt, hry-sšt3 n pr-dw3t, hry-tp nhb, hq3 hwt, hrp i3t nbt ntrt, hrp m ntrw, hrp hwwt nt, hrp šndyt nbt, hry-hb, hry-hb hry-tp, hry-tp nzwt, hry-tp nzwt n mrwt, z3b 'd-mr, sm, sm3 minw, smr w'ty, shd hm-ntr mn-nfr-mry-r ppy, shd hm-ntr dd-swt-tti, sd3wty bity.

The presence of titles incorporating the name of the pyramid of Pepy I show that mhw can date no earlier than that reign. Since he also held priesthoods at the pyramid of Teti, it is possible, as with hnty-k3i (109), that he served under that king in addition.

1 See the photo in Saad, ASAE 43 (1943), pl. XXXVI.

The location of his tomb bears no relation to the monuments of either ruler. One possible explanation of the choice of the Wenis cemetery is that his wife, **z3t nzwt n ht.f nfrt-k3ws**, may have been a daughter of that king, and is further evidence for tombs of the reign of Pepy I being built in no one particular cemetery (see above **idw I; nfr** (22)).

Suggested Date: Perhaps early to middle reign of Pepy I.

ny-'nh-b3 70

Source: Tomb immediately to the north of the causeway of the pyramid of Wenis at Saqqara, east of that of **3ht-htp; hmi** (3)/ **nb-k3w-hr; idw** (82).

Bibliography: **PM** 32, 629.

Relevant Titles: **t3yty z3b t3ty**.

Other Titles: **iry p't, '3 dw3w, hry-sst3, hrp m ntrw, hry-hb, smr w'ty**.¹

The inscriptions that survive from this tomb come from the burial chamber, the decoration of which is not unlike that of **ihy** (15), probably of the reign of Wenis. Such decoration makes perhaps one of its earliest Saqqara appearances in this area. For a general discussion of the date of the major tombs in this area, with the dating of this one to the reign of Wenis, see above under **3ht-htp; hmi** (3).

Suggested Date: Middle reign of Wenis.

ny-'nh-r' 71

Source: Rock-cut tomb in the Central Field at Giza, in the cliff south-east of the pyramid of Khafre.

Bibliography: **PM** 32, 234-5.

Relevant Titles: **imy-r k3t nbt nt nzwt**.

Other Titles: **iwn knmwt, wd wd'-mdw m3' n hry-wdb, mdw rhyt, hry-sst3 n pr-dw3t, hry-sst3 n mdw ntr, hry-sst3 nzwt m swt.f nbt, hrp wsht, hry-hb, hry-tp nzwt, z3 nzwt, smr w'ty, smsw izt**.

The parentage of **ny-'nh-r'** is unknown. He held the title of king's son, but was not **z3 nzwt n ht.f**, nor do any of his titles bear the epithet **n iti.f**. Schmitz links the type of titles he held with those of non-royal king's sons in the later fourth and early fifth dynasties.² The location of this tomb with those of many true king's sons suggests that **ny-'nh-r'** may in fact also have been one

1 The damage to this tomb is very extensive, and **ny-'nh-b3** may have held more titles than those that survive.

2 **Königsson**, 62-3, 88-9.

of these; it is also possible that his tomb was placed in this spot as a special favour of the king, in the manner of that of **dbhn**.¹ His title sequences, according to Baer, date him to the period before the introduction of an organised ranking system,² and these considerations together suggest a date early in the fifth dynasty.

Suggested Date: Early fifth dynasty.

ny-hb-sd-nfr-k3-r' 72

Source: Secondary burial in the tomb of **mry-r'-i3m** (61), east of the pyramid of Pepy II at South Saqqara.

Bibliography: **PM** 32, 683.

Relevant Titles: **imy-r prwy-hd**, **imy-r zš ' nzw**t, **t3yty z3b t3ty**.

Other Titles: **imy-r niwt mr**, **imy-r gs-pr**, **imy-r gswy-pr**, **iry p't**, **h3ty-**, **hrp šndyt nbt**, **sm**, **smr w'ty**, **šhd hm-ntr mn-'nh-nfr-k3-r'** **ppy**, **sd3wty bity**.

Kees places **ny-hb-sd-nfr-k3-r'** in the second half of the reign of Pepy II,³ with Baer dating him more specifically towards the end of the reign.⁴ Kees' argument rests on the assumption that **ny-hb-sd-nfr-k3-r'** was a son of the vizier **idi**, and reasons are given for the rejection of this affiliation above (**ihy-hnt** (16)). It may here be noted that the son of **idi** held the title **imy-r šm'w**, which **ny-hb-sd-nfr-k3-r'** did not. The location of his burial makes it more possible that he was a relation, perhaps son, of **mry-r'-i3m**.

It is possible that he was born at some period not long after a **sd** festival of Pepy II. The exact date of neither of the attested ones is known, but as the celebration of a first such festival after thirty years is likely for the reign of this king, **ny-hb-sd-nfr-k3-r'** may have held office in the last third of the reign.⁵

Suggested Date: Last third of the reign of Pepy II.

ny-s'nh-3ht; iti 73

Son of **'nh-h3f; q3r** (35)

Source: Rock-cut tomb north of the 'pyramid town' east of the tomb of **hnt-k3ws** in the Central Field at Giza, shared with his father.

Bibliography: **PM** 32, 258.

Relevant Titles: **imy-r prwy-hd**, **imy-r prwy-hd n hnw**

1 As related in his biography, **Urk. I**, 18-21.

2 **Rank and Title**, 85 (215).

3 **Veziat**, 45-7.

4 **op. cit.**, 86-7 (229a).

5 **Urk. I**, 114-5; cf. Hornung-Staehelin, **Studien zum Sedfest**, 62.

Other Titles: **imy-r izwy hkr [nzwt], imy-r 'nzwt 'h3w, imy-r w'bty, imy-r prwy-nwb, wr bzt, hry-s3t3 hkr nzwt, z3b 'd-mr, z3 pr-'3, smr w'ty, shd pr-'3 ?, shd z3 pr-hd.**

Baer has been unable to date this tomb more precisely than to the sixth dynasty,¹ but his date for **'nh-h3f** might suggest one in the reign of Pepy II for **ny-s'nh-3ht**. However, **'nh-h3f** has been dated here to the early sixth dynasty, on the basis of the palaeography of the **pr-hd** group. This would suggest a date in the reign of Pepy I for his son, whose inscriptions show no such variations in writing of these signs. Certain features of the tomb of **ny-s'nh-3ht** support such a date. The false door has three jambs and a torus and cornice, with single columns of text on the jambs. A comparable Giza example is that in the tomb of **q3r** (135), which can be no earlier than the reign of Pepy I.² The lintel over the entrance of the tomb bears several standing figures of the deceased separated by columns of text, and is one of a type that appears first at the end of the fifth dynasty (**iy-nfrt** (6)), and which is found with lesser officials from the middle sixth dynasty onwards.³

Suggested Date: Reign of Pepy I, perhaps not early.

ny-sw-wsrt 74

Source: A loose granite block found in the area of the tomb of **nfr** (LG 99), northeast of the tomb of **hnt-k3ws** in the Central Field at Giza.

Bibliography: **PM** 32, 259.

Relevant Titles: **imy-r pr-hd.**

Other Titles: None given.

This block is almost impossible to date with any precision, being totally out of context. The only useful feature is the form of the **pr-hd** group, which most closely resembles that found in the second half of the fifth dynasty (see below page 280). The nearby tomb of **nfr** would also seem to be of the middle fifth dynasty or later.⁴

Suggested Date: Perhaps middle to late fifth dynasty (?).

ny-k3i-'nh 75

Source: Tomb to the east of the Step Pyramid enclosure at Saqqara, D 48.

1 Rank and Title, 87 (232).

2 Simpson, Giza Mastabas II, fig. 32.

3 For a general discussion of such types, see Fischer, Dendera, 59-62, examples in Appendix C, 216-220 (IV-VIII).

4 Tomb, **PM** 32, 258-9; dating, Baer, *op. cit.*, 90 (252).

Bibliography: PM 32, 577.

Relevant Titles: imy-r k3t nbt nt nzwt, imy-r k3t nzwt.

Other Titles: hm-ntr r' hwthr m st-ib-r', hry-s3t3, hrp 'h, smr, smr w'ty, shd w'b w'b-swt-wsr-k3f, shd w'b r' m nhn-r'.¹

This tomb consists of a north-south corridor chapel with two false doors. The panel of one of them contains an abbreviated offering list of twenty elements in canonical order; this may indicate a date in the middle fifth dynasty (Chapter 2.I.G.1). Osiris is invoked in the funerary formulae, a practice not found much before the reign of Neweserre.

Few dates can be assigned with any certainty to the neighbouring mastabas in this cemetery. That of pr-sn may be dated by its inscriptions to the reign of Sahure;² others discussed below (zrw (115), k3i-pw-inpw (141)) will be dated to the mid-later fifth dynasty, and there is also the tomb of m3-nfr,³ which belongs to the very end of the dynasty. A mid-fifth dynasty date is also permissible on these grounds.

Suggested Date: Middle fifth dynasty.

ny-k3w-izzi 76

Sources and Bibliography: 1. Tomb north of that of k3i-gmni (151) in the Teti Pyramid Cemetery at Saqqara - unpublished; for some details, Strudwick, GM 43 (1981), 69-71.
2. Mentioned in the Abydos decree of Teti - BM Stelae I², 32-3, pl. XXXI (BM 626).

3. Depicted among the officials in the reliefs of the causeway of the pyramid of Wenis at Saqqara - unpublished, but see Černý Notebook 120, no. 9.

Relevant Titles: imy-r k3t nbt nt nzwt.

Other Titles: (known at present) imy-r w'bty, imy-r prwy-nwb, imy-r šm'w, iry p't, wty inpw, h3ty-', hry wrw, hts inpw, hry-hb, hry-hb hry-tp, smr w'ty, sd3wty bity.

The details of this man and his date have been discussed in detail by the present writer (*loc. cit.*).

Suggested Date: Middle reign of Teti to early reign of Pepy I.

1 It may be possible to divide these titles into two stages of his career (below page 232).

2 D 45; PM 32, 577.

3 LS 17, PM 32, 575-7.

ny-k3w-ptḥ 77

- Source: Unfinished false door in Manchester, University Museum 10780, exact provenance unknown, but probably from Saqqara.
- Bibliography: **PM** 32, 744-5; to be republished by the writer.
- Relevant Titles: **imy-r pr-ḥd**.
- Other Titles: **iwn knmwt, imy-ḥt pr-ḥd, w'b nzw, mdw rhyt, ḥm-ntr r' m nḥn-r', ḥm-ntr s3hw-r', [ḥtm ḥ3]t df3w bity, zš '-nzw m w'bt, zš '-nzw m prwy-nwb, shd zš pr-ḥd, shd zš ptḥ, shd zš hkr nzw.**

This false door does not possess a torus or cornice, and is therefore most likely of fifth dynasty date. The even length of the inscriptions on the jambs with small figures of the deceased at the bottom of each do not suggest the first half of that period.

ny-k3w-ptḥ has a son shown on this false door by the name **ḥ'f-ptḥ** with the title **zš pr-ḥd**. A man with the same name and title appears in the tomb of **ty** (157).¹ The date of this latter tomb is not certain, but will be dated below to the later reign of Neweserre. If these two representations are of the same man, **ny-k3w-ptḥ** could be dated to shortly after the middle of the fifth dynasty.

Suggested Date: Middle fifth dynasty or slightly later.

ny-k3w-r' 78

- Source: Rock-cut tomb in the Central Field at Giza, in cliff south-east of the pyramid of Khafre, LG 87.
- Bibliography: **PM** 32, 232-3.
- Relevant Titles: **t3yty z3b t3ty**.
- Other Titles: **imy-iz, imy-r** , **iry p't, '3 [dw3w] ?, wr 5**
pr-dḥwt, ḥ3ty-', ḥm b3w p, ḥry-tp nḥb, ḥry-tp nḥb n iti.f, ḥry-ḥb n iti.f, ḥry-ḥb ḥry-tp, ḥry-ḥb ḥry-tp n iti.f, z3 nzw n ht.f, z3 nzw n ht.f smsw, z3 nzw smsw, smr w'ty, sd3wty bity.

ny-k3w-r' was a true king's son, as may be seen from the titles with **n iti.f**. The location of the tomb makes it almost certain that his father was Khafre. As for his mother, Reisner categorically states that it was queen **pr-[snt]**, the owner of tomb LG 88.² There actually appears to be no explicit evidence for this, and so it is presumably based on the closeness of their tombs and the fact that the owner of the other nearby tomb (LG 89, **shḥm-k3-r'** (125)) had a different mother.

1 Epron-Wild, *Tombeau de Ti I*, pl. LIII.

2 **Mycerinus**, 242. For the tomb of this queen, see **PM** 32, 233.

A will inscribed in the tomb is dated to a **rnpt zp 12**.¹ From the assumptions made on page 7 above, **ny-k3w-r'** would have been born in the reign of Khafre, and thus would be no older than twenty-two at the end of his father's reign, surely a little young to be making a will, although we know very little about the process at this time. **rnpt zp 12** would then apply to a successor, and only Menkaure has any possible cattle counts approaching that number.² It would thus be most logical for **ny-k3w-r'** to have held his high offices in the later reign of Menkaure.

Suggested Date: End of the reign of Menkaure or a little later.

ny-k3w-r' 79

Source: Tomb at Saqqara, exact provenance unknown.
 Bibliography: **PM 32**, 697.
 Relevant Titles: **imy-r k3t nt nzwt**.
 Other Titles: **rh nzwt ?**, **hm-ntr nfr-dd-k3-r'**.

All that is known from this tomb is the name and titles above, the only information that may be gained from which is that this man could have been no earlier than the reign of Djedkare.

Suggested Date: Late fifth dynasty or later.

ny-k3-r' 80

Source: Various elements of a tomb, exact provenance unknown, but said to come from Saqqara.
 Bibliography: **PM 32**, 696-7; many pieces unpublished.
 Relevant Titles: **imy-r šnwt nt hrnw**, **imy-r šnwt**.
 Other Titles: **imy-r bityw nb**, **imy-r prw msu nzwt m prwy**, **imy-r pḥw nb**, **imy-r nw nb**, **imy-r ḥwt iḥwt**, **imy-r ḥwt-3t**, **imy-r zš md3t nt šnwt**, **imy-r sb/// nb**, **imy-r**

srw, **imy-r**  **, wr md šm'w**, **rh nzwt**, **hm-ntr ny-wsr-r'**, **hm-ntr r' m [st]-ib-[r']**, **hm-ntr r' m šzp-ib-r'**, **hm-ntr hr ///w**, **[hm-ntr] hr st-ib-t3wy**, **hm-ntr [s3h]w-[r']**, **hry-tp šnwt**, **zš wr md šm'w**, **šd zš šnwt**.

This tomb may have been found by Firth during his excavations in 1925-6 at the south-east corner of the Step Pyramid enclosure.³ It cannot date earlier than the middle of the fifth dynasty because of

1 **Urk. I**, 16.14

2 A tomb with the names of workmen's crews of Menkaure on some blocks also has a date of an eleventh count of an unnamed king, although this particular block could have come from elsewhere at Giza (Junker, **Giza X**, 77-8 (9), Abb. 35 (10)).

3 Scott, **BMAA NS 11** (1952), 118.

the appearance of the names of Neweserre in titles. Further indications support a similar date. The style of the statues would seem to be that of the middle fifth, and the surviving elements of the false door show a large figure of the deceased on the inner jambs, accompanied by his son. These jambs are wide, each bearing four columns of inscription. This resembles examples of early to mid-fifth date, and the inscriptions are cut in raised relief, another indicator of the same period (Chapter 2.I.F.1). ny-k3-r' 's titles are of a sufficiently high level that one might have expected him to have followed the trend towards the use of the new type of false door with cornice and torus moulding if he were to date to the later part of the dynasty.

Suggested Date: Perhaps middle fifth dynasty, not much later than the reign of Neweserre.

nb-m-3ht 81

Source: Rock-cut tomb in the Central Field at Giza, in the cliff south-east of the pyramid of Khafre, LG 86.

Bibliography: PM 32, 230-2.

Relevant Titles: t3yty z3b t3ty.

Other Titles: iry p't, wr ht, [wr] 5 [pr-dhwty] ?, hry-sšt3 n

iti.f, ht , hry-hb hry-tp, z3 nzwt n ht.f, z3 nzwt n ht.f [smsw], z3 md3t ntr, z3 md3t ntr n iti.f, smr w'ty, smr w'ty n iti.f, smsw snwt, smsw snwt n iti.f.

The mother of nb-m-3ht was queen mrs-'nh III, and he is depicted in the reliefs of her tomb (G7530 + 7540) and included in statue groups.¹ She seems to have been a wife of Khafre.² On the basis of the assumptions made on page 7 above, it is likely that nb-m-3ht, as mrs-'nh 's eldest son,³ was not born until at least the early part of the reign of Khafre. Schmitz argues that his apparent lack of the title z3 nzwt n ht.f smsw, although he is referred to as the eldest son of mrs-'nh, suggests that the use of smsw in such titles is more an indication of rank than of simple seniority by age.⁴ However, this title may be restored in this tomb: the entrance drum has a gap between n ht.f and nb-m-3ht which could have fitted smsw.⁵ For further details which may affect the date, see above under iwn-minw (8).

Suggested Date: End of the fourth dynasty.

1 Dunham-Simpson, Giza Mastabas I, 25.

2 id., ib., 7.

3 id., ib., pl. XVII e.

4 Königssohn, 97-102.

5 Hassan, Giza IV, fig. 74 (no photograph given).

nb-k3w-hr; idw 82

- Source: Mastaba usurped from 3ht-htp; hmi (3), north of the causeway of the pyramid of Wenis at Saqqara.
- Bibliography: PM 32, 627-9; for the separation of the titles of the two owners of this tomb, see Strudwick, GM 56 (1982), 89-94.
- Relevant Titles: imy-r hwt wrt 6, imy-r šnwty, t3yty z3b t3ty.
- Other Titles: imy-r šm'w, h3ty-', hry-tp nzwt, z3 nzwt, z3 nzwt smsw, z3 nzwt smsw n ht.f, smr w'ty, sd3wty bity.

For the reasons for dating the usurpation of this mastaba no earlier than the reign of Pepy II, see the above article by the present writer.

Suggested Date: Reign of Pepy II, if not later.

nfr 83

- Source: Drum found out of place in tomb G1461 at Giza. Now in the Museum of Fine Arts, Boston, 21.3080.
- Bibliography: PM 32, 64; to be published by the writer in JEA 71 (1985).
- Relevant Titles: imy-r pr-hd.
- Other Titles: imy-r zš 3ht-hwfw, hry-sšt3 3ht-hwfw.

This drum does not originate in the tomb in which it was found, but was reused as a roofing beam. Differences in titles and palaeographical considerations make it unlikely that it was taken from the tomb of a better-known nfr at Giza (84) (G2110). The most useful feature for dating is the form of the pr-hd group, which is more akin to that of the early to middle fifth dynasty than that of the sixth (below page 280).

Suggested Date: Early to middle fifth dynasty.

nfr 84

- Source: Tomb in the Western Cemetery at Giza, G2110.
- Bibliography: PM 32, 72-4; one further fragment, Birmingham City Museum 241'57, Fischer, Varia, 31-2. Entrance drum probably that found loose in tomb G3015, now Pennsylvania Mus. E 13531 (Fisher, The Minor Cemetery at Giza, pl. 50 (5)), rather than Museum of Fine Arts 21.3080 (see above nfr (83)).
- Relevant Titles: imy-r pr-hd, imy-r prwy-hd.
- Other Titles: imy-r pr 'h3w, imy-r hkr nzwt nb, imy-r zš 'prw, imy-r zš hryt-' nzwt, imy-r sty df3w, wr md šm'w, rh nzwt, hry-sšt3 nzwt m swt nbt, hq3 hwt, hrp 'prw nfrw, zš ' nzwt, zš pr-'3.

The tomb of **nfr** was perhaps the first chapel in the western cemetery after that of **hm-iwnw** (96) to have been fully decorated. It is also one of very few in the same cemetery to have incorporated a linen list into the design of the panel of the false door. It is possible that these and other features of the tomb date it to the reign of Khafre or a little later (Chapter 2.II.B. and C.2).

Suggested Date: Reign of Khaire or a little later.

nfr-m3't 85

Source: Mastaba in the Eastern Cemetery at Giza, G7060.
 Bibliography: **PM** 3², 183; improved readings of inscriptions from examination of excavation records in Boston.
 Relevant Titles: **t3yty z3b t3ty**.
 Other Titles: **imy-iz, iry p't, wr 5 pr-[dhwty], mniw nhn, h3ty-', hry-tp nhb, hrp i3t nbt ntrt, hrp 'h, z3 nzwt, z3 nzwt n ht.f, smr w'ty, sd3wty bity**.

The genealogy of **nfr-m3't** may be reconstructed from the architrave inscriptions of his false door and that of his son **h'f-snfrw**.¹ **nfr-m3't** is called the son of **nfrt-k3w**, the 'eldest daughter of the King of Upper and Lower Egypt Sneferu'. On the basis of this, she is assigned the uninscribed mastaba G7050, as G7070 belongs to **h'f-snfrw**. As her mother is unknown, her age at the death of Sneferu is impossible to calculate, and it is possible but by no means certain that **nfr-m3't** was alive at the accession of Khufu. We do not know the identity of her husband; he cannot have been Khufu, as one might otherwise expect the name of Sneferu to be less prominent, and her children to have had titles with **n iti.f**.

If this supposition is correct, **nfr-m3't** would be one of the senior members of the family at the end of the reign of Khufu, at which point he would perhaps have held his important titles and decorated his tomb. Although probably not a true king's son, it is clear from his titles that he was placed on a par with those who were; his position in the reign of Khafre may have been not unlike that of **'nh-h3f** (34) in the reign of Khufu.

Suggested Date: Early to middle reign of Khafre.

nfr-m3't 86

Source: Tomb near the pyramid of Meydum, no. 16.
 Bibliography: **PM** 4, 92-4.
 Relevant Titles: **imy-r k3t nbt nt nzwt, t3yty z3b t3ty**.
 Other Titles: **iry p't, wr 5 pr-dhwty, mniw nhn, r p nb, h3ty-', hm-ntr b3 'npt, hm-ntr b3stt, hm-ntr ssmtt, hrp i3t nbt ntrt, z3 nzwt smsw, sm3 minw, sd3wty bity**.

1 LD II, 16 (lower).

The large mastabas at Meydum probably belong to the period following the construction of the pyramid, begun probably by Huni and completed after his death by Sneferu. It is likely that men of such high rank as nfr-m3't were buried at this site because of a relationship with the king, although whether nfr-m3't was a true king's son is unknown. Schmitz would see in him a son of Huni and brother of Sneferu, a theory which best suits the location of the tomb.¹ It is thus most likely that he would have been vizier under Sneferu. hm-iwnw (96), buried at Giza, may have been a son of nfr-m3't.² His tomb may be independently dated to the middle and later parts of the reign of Khufu on independent grounds, also placing nfr-m3't in the reign of Sneferu.

Suggested Date: Perhaps middle of the reign of Sneferu.

nfr-sšm-ptḥ; šš; wd3-ḥ3-tti 87

Source: Northernmost tomb in the 'Rue de Tombeaux' in the Teti pyramid cemetery at Saqqara.

Bibliography: PM 32, 515-6; the unpublished parts are noted in JEA 66 (1980), 2; also personal examination of tomb.

Relevant Titles: (in earlier career only) imy-r ḥwt wrt.

Other Titles: 1. Earlier career: iwn knmwt, imy-r wpt, imy-r wpt ḥtpw ntr, wr md šm'w, mdw rhyt, ḥry-sšt3 n wdt-mdw nbt, ḥnty-š dd-swt-tti, ḥry-tp nzwt, z3b 'd-mr, z3b šhd zš iryw sprw, šhd ḥm-ntr dd-swt-tti.

2. Later career: im3-', imy-iz nḥn, imy-r izwy hkr nzwt, imy-r 'h-ntr šm'w, imy-r w'bt, imy-r ḥnty-š, imy-r ḥt nbt ddt pt qm3t t3, imy-r swt špswt pr-'3, imy-r sqbbwy pr-'3, imy-r šwy pr-'3, imy-ḥt ḥm-ntr mn-nfr-mry-r' ppy, imy-ḥt ḥm-ntr dd-swt-tti, iry p't, iry nfr-ḥ3t, '3 dw3w, ' nmt, 'd-mr dp, ḥ3ty-', ḥry-sšt3 nzwt m swt.f nbt, ḥry-tp nḥb, ḥrp i3t nbt ntrt, ḥrp m ntrw, ḥrp šndyt nbt, ḥry-ḥb, ḥry-ḥb ḥry-tp, ḥry-tp nzwt pr-'3, sm, smr w'ty, smsw snwt.

This tomb is particularly important for the dating of the Teti pyramid cemetery. It may be divided into two parts, that published by Capart, and that recently re-excavated by the Egypt Exploration Society. In both sections, the titles connect nfr-sšm-ptḥ with the pyramid of Teti, but in the most recently cleared part he is also given titles connected with the pyramid of Pepy I. This implies that he began decorating his tomb in the reign of Teti, was promoted at the accession of the new king and then completed his tomb. Few of the older titles appear in the newer part of the tomb.

Suggested Date: Reign of Teti to early Pepy I.

1 Königssohn, 65-6.

2 Junker, Giza I, 151-3.

nfr-sšm-r'; ššī 88

Source: Southern tomb in the 'Rue de tombeaux' in the Teti pyramid cemetery at Saqqara.

Bibliography: PM 3², 511-2.

Relevant Titles: imy-r prwy-hd, imy-r hwt wrt, imy-r hwt wrt 6, imy-r zš ' nzw, imy-r šnwty, imy-r k3t nbt nt nzw, t3yty z3b t3ty.

Other Titles: iwn knmw, imy-r i'-r nzw nb, imy-r izwy hry htm md3t, imy-r izwy hkr nzw, imy-r w'bty, imy-r wpt, imy-r wpt š3t, imy-r wdt-mdw nbt š3t nt nzw,

imy-r prwy-nwb, imy-r hnw, imy-r zš, imy-r zš (²⁷⁷), imy-r sqbbwy pr-'3, imy-r šm'w, imy-r šn-t3 nb, imy-r gs-pr, imy-r ddt pt qm3t t3, iry p't, mdw rhyt, h3ty-', hnty-š dd-swt-tti, hry-tp nzw, smr w'ty, shd hm-ntr dd-swt-tti.¹

Firth believed that this tomb was the first of the large ones to be built on this site, on the grounds of its simplicity and lack of decoration relative to the others.² According to Baer, the title sequences place nfr-sšm-r' in period VIB, later than k3i-gmni (151) but the same as the owners of the other great mastabas.³ For a more thorough discussion of the relative dating of the cemetery, see above under mrrw-k3i (68). It is almost impossible to decide whether k3i-gmni or nfr-sšm-r' was the earlier, but the possibility of them being largely contemporary should perhaps be considered.

Suggested Date: Perhaps middle of the reign of Teti.

nfr-sšm-sš3t; hnw 89

Source: Tomb east of the Step Pyramid at Saqqara, exact position unknown, E 11.

Bibliography: PM 3², 585-6.

Relevant Titles: imy-r hwt wrt 6, imy-r zš ' nzw, imy-r k3t nbt nt nzw, t3yty z3b t3ty.

Other Titles: iwn knmw, imy-r izwy hkr nzw, imy-r w'bty, mdw rhyt, mdh zš nzw, h3ty-', hry-tp nzw, z3 nzw n ht.f, smr w'ty, sd3wty bity.

The chapel of this tomb consists of two brick-built rooms, one of which contains a false door with side pieces. Although the details of the false door are not the same, the whole decorated surface resembles that of s3bw; ibbi (116) of the reign of Teti. The

- 1 One pillar in this tomb contains the three titles imy-r šm'w, imy-r gs-pr and imy-r hwt wrt, which are found nowhere else, and conceivably belongs to a pre-vizierial phase of his career (Capart, *Une rue de tombeaux à Saqqara*, pl. XIII (right)).
- 2 Teti Pyramid Cemeteries I, 15.
- 3 Middle reign of Teti to Pepy I, Rank and Title, 93 (274).

location of the tomb is somewhere between the pyramids of Wenis and Weserkaf, which kings' cartouches are found in the names of two offering bearers in the chapel. Baer dates the tomb to periods VIC or VII.¹ Both these dates precede the construction of the cemetery of Pepy II at South Saqqara, and the location of the tomb would then be not unlike that of others of the same period (see above **idw** I; **nfr** (22)). Kanawati has suggested that this man may be the vizier **hnw** depicted in the mortuary temple of Pepy II,² which would provide a further attestation for the otherwise unknown **hnw** (108). As this is not absolutely certain, the separate listing below for **hnw** has been retained.

Suggested Date: Perhaps reign of Merenre to early Pepy II.

nhbw; mry-r'-mry-'nh-pt 90

Sources and Bibliography: 1. Tomb in the Western cemetery at Giza, G2381: **PM** 32, 89-91; incompletely published - examination of excavation records and material in Boston.
2. Leader of at least three expeditions to the Wadi Hammamat: a. **Urk.** I, 93; b. **Urk.** I, 94; c. Goyon, **Nouvelles inscriptions rupestres du Wadi Hammamat**, no. 21.

Relevant Titles: **imy-r k3t, imy-r k3t nbt nt nzwt.**

Other Titles: **imy-r wpt nzwt mn-nfr-mry-r' ppy, imy-r hnty-š mn-nfr-mry-r' ppy, imy-r qdw, '3 dw3w, mty n z3, mdh nzwt, mdh qd nzwt, mdh qd nzwt m prwy, hry-šš3 n w'bty, hrp šndyt nbt, hry-hb, hry-hb hry-tp, hry-tp nzwt, sm, smr w'ty, smsw snwt, šhd qdw, špss nzwt, qd nzwt m prwy.**

The tomb of **nhbw** is one of the group of mastabas of the **sndm-ib** family. His relationship to them is unknown, but Reisner seems to have considered him the son of **hnmw-nti**.³ A relationship to this family is evident from his titles connected with building work. From his biography it is apparent that he lived in the reign of Pepy I.⁴ One of his Hammamat inscriptions (a) is dated to **rnpt m-ht zp 18**, being the occasion of the **sd** festival of Pepy I. The exact length of the reign of Pepy I is open to dispute, but the highest count attested is the twenty-fifth,⁵ and so the date of the expedition is probably well into the second half of the reign.

Suggested Date: Middle to late reign of Pepy I.

- 1 Later reign of Pepy I to early Pepy II, or middle reign of Pepy II, **Rank and Title**, 93-4 (275).
- 2 **Governmental Reforms**, 79.
- 3 **ASAE** 13 (1914), 249; **BMFA** 11 (1913), 62. Brovarski now suggests **sndm-ib; mhi** (121) as his father, **L'Égyptologie en 1979** II, 117.
- 4 **Urk.** I, 215-21; Dunham, **JEA** 24 (1938), 1-8.
- 5 **Urk.** I, 95.16.

ntr-wsr 91

- Source: Tomb north of the enclosure wall of the Step Pyramid at Saqqara, no. 78 (D 1; S 901).
- Bibliography: PM 32, 485.
- Relevant Titles: imy-r hwt wrt, imy-r zš 'nzwt, imy-r k3t nbt nt nzwt.
- Other Titles: iwn knmwt, imy-r wsht, wr md šm'w, wd-mdw m3' n hry-wdb, mdw rhyt, nst hntt, hm-ntr m3't, hry-wdb m hwt-'nh, hry-sšt3 n wdt-mdw nbt nt nzwt, hry-sšt3 n mdw ntr, hry-sšt3 n mdw št3, hry-sšt3 n mdw št3 n hwt wrt, hrp wsht, hrp zš, hrp zš iry sprw, hrp zš nb, hry-tp nzwt, z3b 'd-mr, smsw izt, šhd wr md šm'w.

The major problem relative to the dating of this tomb is the nature of ntr-wsr's relationship to the well-dated vizier r'-špss (95), whose mastaba is nearby. It is usually accepted that the latter is the son of ntr-wsr, as a son by the name of r'-špss appears in this tomb. However, as r'-špss had a son called ntr-wsr, the relationship could be reversed. Baer's conclusions are of assistance here: both ntr-wsr and r'-špss date to his period VB;¹ as the latter may be dated to the reign of Djedkare on independent evidence, if ntr-wsr was indeed his son, he would probably date to the end of the reign of Djedkare or the beginning of that of Wenis, Baer period VC. In fact pr-nb, who is almost certainly a son of r'-špss, belongs to the latter period,² suggesting that ntr-wsr was the senior of these men, and consequently may be dated to the reigns of Neweserre to Menkauhor.

Suggested Date: Later reign of Neweserre to that of Menkauhor.

r'-wr 92 ('r'-wr III')

- Source: Tomb at Giza, west of the tomb-complex of hnt-k3ws, LG 94.
- Bibliography: PM 32, 242.
- Relevant Titles: imy-r k3t nt nzwt.
- Other Titles: iwn knmwt, imy-r mš['], wr idt, hry-hb, z3b 'd-mr.

Two rather different dates have been suggested for this tomb. Reisner, for reasons which are not very clear, dated it to the late fourth dynasty or early fifth,³ while Baer prefers the sixth dynasty, quoting the painted decoration in the burial chamber, the alignment of this chamber and its sloping shaft.⁴ The false door has two narrow jambs either side of the central niche, with one

1 Reign of Neweserre to middle Djedkare, **Rank and Title**, 97 (294) for ntr-wsr.

2 **op. cit.**, 71 (142); tomb, PM 32, 497-8.

3 **Giza I**, 152 (5).

4 **op. cit.**, 98 (299).

column of inscription per jamb, and conforms to a pattern very common at Giza from the mid-fifth dynasty onwards (Chapter 2.II.E). Reasoning based on the shaft of the tomb is not particularly convincing, as the same type is found certainly in the late fourth dynasty.¹ The painted decoration is a far stronger argument, generally attested first in the tombs of viziers at Saqqara at the end of the fifth dynasty, and becoming more frequent in the sixth.²

Suggested Date: Perhaps late fifth to early sixth dynasty.

r'-wr 93

Source: Tomb west of the subsidiary pyramid in the mortuary temple of Teti, Saqqara.

Bibliography: **PM** 32, 558; see now, Said Amer el-Fikey, **The Tomb of the Vizier Re'-wer at Saqqara**; also examination of tomb.

Relevant Titles: **t3yty z3b t3ty**.

Other Titles: **im3-**, **imy-r šm'w**, **iry p't**, **'d-mr dp**, **h3ty-**, **hrp šndyt nbt**, **hry-hb**, **hry-hb hry-tp**, **sm**, **smr w'ty**, **smsw snwt**, **sd3wty bity**.

el-Fikey dates this tomb to the reign of Pepy I on stylistic and positional grounds.³ Although his date for **hnty-k3i**; **ihhi** (109) is in all probability too late, it is clearly earlier than the tomb of **r'-wr**, which, with its north-south chapel, is somewhat unusual for the sixth dynasty. Malek has suggested that **r'-wr** may be the vizier whose name was removed from the Dahshur decree of cattle-count 21 of Pepy I, linking this with the damage done to the name of **r'-wr** in this tomb.⁴ The major objection to this is the partly

visible title in this decree employing the signs \triangle \downarrow , perhaps

imy-r zš' nzwt, or more likely **sdt nzwt**, neither of which appear in the tomb of **r'-wr**. One would then have to assume that this title was given to **r'-wr** after the decoration of his tomb, a more probable theory than that of el-Fikey - that it was such a common element of the titulary of a vizier that it was omitted.⁵

Suggested Date: Late reign of Pepy I.

1 Reisner, *loc. cit.*

2 For example, the tomb of **ny-'nh-b3** (70) in the Wenis cemetery, and all the tombs in the Teti pyramid cemetery.

3 *op. cit.*, 44.

4 See el-Fikey, *op. cit.*, 46, also Kanawati, *CdE* 56 (1981), 209.

5 For possible reasons for the disgrace of **r'-wr**, see el-Fikey and Kanawati, *loc. cit.*

r'-h_wf 94

Source: Mastaba in the group of tombs at the south-west corner of the Step Pyramid enclosure, Saqqara.
 Bibliography: PM 32, 633.
 Relevant Titles: imy-r h_wt wrt.
 Other Titles: h_ry-tp nzwt.

The tomb itself provides only vague indications for a date, in that the statues found are probably of a sixth dynasty type. It is probably later than the original Wenis cemetery, indicating the beginning of the sixth dynasty as the earliest possible date. r'-h_wf may perhaps be a son of 3h_t-h_tp (4), whose tomb is a little further to the east. A son by this name appears in the tomb of 3h_t-h_tp with the title z3b sh_d zš, not attested in the tomb of r'-h_wf.¹ The two titles given above are however part of the titulary of 3h_t-h_tp, possibly also suggesting that they were father and son. Such a relationship would date r'-h_wf to the early or middle sixth dynasty.

Suggested Date: Early to middle sixth dynasty.

r'-špss 95

Probably son of n_tr-wsr (91)

Source: Tomb north of the enclosure wall of the Step Pyramid at Saqqara, LS 16 (S 902).
 Bibliography: PM 32, 494-6.
 Relevant Titles: 1. Before Vizierate: imy-r zš 'nzwt, imy-r šnwty, imy-r k3t nbt nt nzwt.
 2. When Vizier: imy-r zš 'nzwt, t3yty z3b t3ty.
 Other Titles: 1. Before Vizierate: iwn knmwt, imy-r izwy mrt, imy-r izwy h_ry h_tm [md3t], imy-r wsht, imy-r šm'w, wr md šm'w, wd-mdw n h_ry-wdb, mdw rhyt, mdh zš nzwt, nst hntt, hm-n_tr m3't, hm-n_tr hqt, h_ry-wdb m hwt-'nh, h_ry-sšt3 n wdt-mdw nbt nt nzwt, h_ry-sšt3 n mdw št3 n hwt wrt 6, h_rp wsht, h_rp zš, h_rp zš iry sprw, ht h3, h_ry-tp nzwt, z3b 'd-mr, sh_d wr md šm'w.
 2. When Vizier: Not known.

r'-špss is one of the all too infrequent individuals who may be dated with a fair degree of precision, as two copies of a letter addressed to him as vizier from Djedkare were set up in a court south-east of the main tomb.² This letter is also important as the only place in the area of the tomb where r'-špss was given the title of t3yty z3b t3ty, showing that the greater part of the tomb had been completed before his promotion, which thus seems to have

1 Petrie-Murray, **Memphite Tomb Chapels**, pl. V.
 2 One, **Urk. I**, 179-80.

come later in life. Baer has used the title sequences of r'-šps to help form the base chart for his period VB.¹ The vizier **sndm-ib; inti** (120) is perhaps one of the latest officials of this period, and may be independently dated to the end of the reign of Djedkare; he was presumably a successor of r'-šps, who may thus be dated to about the middle of that reign.

Suggested Date: Perhaps middle of the reign of Djedkare.

hm-iwnw 96

Probably son of **nfr-m3't** (86) of Meydum.

Source: Nucleus mastaba of Cemetery G4000 at Giza, west of the pyramid of Khufu.

Bibliography: **PM** 32, 122-3.

Relevant Titles: **imy-r k3t nbt nt nzwt, t3yty z3b t3ty.**²

Other Titles: **iry p't, wr 5 pr-dhwt, mniw nhn, mdw hp, mdw k3-**

hd, mdh zš nzwt, mdh , r p nb, h3ty-', hm-ntr b3 'npt, hm-ntr b3stt, hm-ntr šsmtt, hrp i3t nbt ntrt, hrp mrt t3-mhw šm'w, hry-hb, z3 nzwt, z3 nzwt n ht.f, smr w'ty, smsw izt, sd3wty bity.

The possible relationship of **hm-iwnw** to **nfr-m3't** has been discussed in the entry for the latter. As one of the nucleus mastabas around the Great Pyramid, it is very probable that it was built in the reign of Khufu. Quarry-marks on the casing stones give more indication of the date at which it was built.³ Dates of **rnpt zp 8** and **10** are found thereon, which are probably near the end of that reign as the highest possible count suggested for Khufu is twelve.⁴

Suggested Date: Middle to later reign of Khufu.

1 Rank and Title, 101 (315), 225.

2 The suggestion that he may have been promoted to vizier after the completion of the decoration of his tomb (Schmitz, **Königssohn**, 102) is erroneous: all of the titles found inside the tomb (Junker, **Giza I**, Abb. 23, a, b) occur also on the statue Hildesheim 1962 (*id.*, *ib.*, Taf. XXIII) with the exception of **hrp i3t nbt ntrt** and **t3yty z3b t3ty**; the probable original presence of the latter title in the tomb is suggested by the existence of the last sign of **wr 5 pr-dhwt**, a title borne only by viziers.

3 Junker, **Giza I**, 157-61.

4 In the tomb of **sš3t-shntyw**, although this could equally be of the reign of Khafre (Smith, **JNES** 11 (1952), 127 (3), fig. 6).

hn-k3 97

Source: Statue, Berlin (West) Mus. 7334, and statuette, in 'Vienna Mus.' (Kunsthistorisches Museum ?), both from Meydum, exact provenance unknown.

Bibliography: PM 4, 95, 96; for Berlin 7334, see also Kaiser, **Ägyptisches Museum Berlin** (1967), 26 (231) with plate.

Relevant Titles: **imy-r k3t nbt nzwt.**

Other Titles: **iwn knmwt, imy-r ḥ'wy-snfrw, wr md šm'w, wd-mdw n ḥry-wdb, mdw rhyt, nst ḥntt, z3b 'd-mr.**

It is presumed that these two monuments both belonged to the same man, although the only title common to both is **wr md šm'w**. The statue would appear to be of good fifth dynasty work, perhaps of the middle of the period. Baer has dated the monuments to periods VB-C, the middle to later fifth dynasty.¹ There is only one other certain holder of the title **imy-r ḥ'wy-snfrw** in the Old Kingdom, **dw3-r'** (162), buried at Dahshur. His titulary is not dissimilar, and he dates to the middle fifth dynasty or slightly later. The similarities of these two men may be due to a reorganisation of the cult of Sneferu that seems to have taken place at that time, and it is possible that these men were among the first to be associated with the cult of the pyramids of Sneferu.²

Suggested Date: Middle fifth dynasty.

h3zi 98

Source: A false door found north of the Step Pyramid at Saqqara, exact position unknown. Now Cairo, CG 1413.

Bibliography: PM 32, 506.

Relevant Titles: **imy-r prwy-ḥd, imy-r šnwtj, imy-r k3t nbt nt nzwt.**

Other Titles: **imy-r ḥt wdt m k3t ḥft-ḥr, imy-r zš (⁷¹¹), ḥry-sšt3 n wdt nbt, ḥry-tp nzwt, šḥd zš ' nzwt, šḥd zš ' nzwt ḥft-ḥr.**

The cornice and torus moulding of this door indicate that in all probability it is not earlier than the later fifth dynasty. The arrangement of the panel and apertures is very unusual; the panel is slightly elongated by the addition of offerings, and has very small apertures, but then, in place of the continuation of the outer jambs that is normal, figures of the deceased and his son are found. In some respects this resembles the false door of **mrw** (64), of the reign of Teti to Pepy I. There is a standing figure of the deceased on the architrave, a feature sometimes found in the late

1 Rank and Title, 105 (338a).

2 cf. Schmitz, **Königsohn**, 155-8.

fifth dynasty (Chapter 2.I.E.1). The use of two pairs of jambs on the false door of an important official suggests a date not much later than the early sixth dynasty, while the panel arrangement suggests the later fifth or early sixth.

Suggested Date: Late fifth or early sixth dynasty.

ḥkni-hnmw 99

Source: Tomb in the Central Field at Giza, near the rock-cut tombs in the cliff west of the funerary complex of **ḥnt-k3ws**.

Bibliography: **PM** 32, 238.

Relevant Titles: **imy-r ḥwt wrt**.

Other Titles: **iwn knmwt, imy-irty 'prw imw, imy-r w3t ḥr, imy-r mš', imy-r nw ḥ3st, imy-r zt ḥ3swt, 'd-mr zt, wr md šm'w, mdw rhyt, rh nzwt, ḥrp mitr, ḥrp zš nb, hry-tp nzwt, z3b 'd-mr.**

There is little evidence for dating this tomb. The east-west offering room of the chapel would imply the existence of a false door with torus and cornice (although none has survived), and so the tomb is not likely to be earlier than the sixth dynasty for a man of this rank at Giza (Chapter 2.II.D). Baer has dated the tomb to his period **VIG**.¹ Such a date does not contradict the other evidence, although it seems that many of the surrounding tombs should not be placed this late on conventional dating.² Two titles held by **ḥkni-hnmw** are found most frequently in the later part of the Old Kingdom: **imy-irty 'pr imw** is found in the memphite region in the titulary of **k3i-ny-nbf**³ and at Zawayda in that of **ḥnti**;⁴ the title **imy-r nw ḥ3st** is also held by **izt3i**.⁵ A date not early in the sixth dynasty is perhaps likely.

Suggested Date: Middle sixth dynasty or later.

ḥtp-ḥr-n-ptḥ 100

Source: A doorjamb in Cairo, JE 15048, provenance unknown.

Bibliography: **Urk.** I, 231; Dittman, **ZAS** 77 (1941), 9; Helck, **Beamtentitel**, 112 n.5; also personal examination of original.

Relevant Titles: **imy-r k3t nbt**.

Other Titles: **iwn knmwt, imy-iz nḥn, imy-r izw, imy-r ph nb, imy-r ḥmwt nbt, '3 dw3w, 'd-mr dp, wr w' spt, wr**

1 Late reign of Pepy II, **Rank and Title**, 107 (350).

2 cf. **PM** 32, 237-9.

3 Martin, **Hetepka**, pl. 31 (74).

4 Fischer, **Coptite Nome Dynasties**, pl. XII (9).

5 Málek, **GM** 18 (1975), 29-32.

m3, wr md šm'w, mdḥ inpw [ḥnty t3-dsr] ?, mdḥ bity, mdḥ pr, mdḥ nwd
 ?, mdḥ nḥn, mdḥ šn-t3, ḥm-ntr ḥr inpw ḥnty pr smswt, ḥry-wdb m ḥwt-
 'nḥ, ḥry-sšt3 nzwt, ḥq3' nzwt, ḥq3 ḥwt-'3t, ḥrp i3t nbt ntrt, ḥrp iz

zḥ inpw, ḥrp m ntrw, ḥrp st df3w, ḥt , ḥry-ḥb ḥry-tp, z3b 'd-
 mr, z3b wd-mdw n ḥry-wdb, zš ḥryt-' nzwt, sm3 inpw, smr, smsw snwt,

smk  ?, shd zš pr md3t, sdt nzwt.

This monument is remarkable by virtue of its large collection of archaizing titles, some of which would seem to be inventions on the part of the owner. It is consequently difficult to date, although such a tendency to employ ancient titles is a practice rarely encountered before the sixth dynasty.¹

Suggested Date: Early/mid-sixth dynasty or later.

ḥ'-inpw 101

Source: Elements of a false door, provenance uncertain but probably from Saqqara; now in Chicago, Field Museum of Natural History.

Bibliography: PM 32, 691; unpublished.

Relevant Titles: imy-r pr-ḥd²

Other Titles: [imy-r] izwy ḥkr nzwt nb, imy-r wd3 n nwb m prwy
 pr-'3, imy-r pr 'ḥ3w, [imy-r] pr[wy]-nwb, imy-r
 ḥkr nzwt, rh nzwt, rh nzwt pr-'3, ḥm-ntr b3-nfr-
 [ir-k3-r'], ḥm-ntr ny-wsr-r', ḥry w3wt, ḥry-sšt3,
 shd pr-'3.

The name of Neweserre is found on the column of text at the rear of the central niche, a feature only found in the period of the reigns of Neweserre to Djedkare, suggesting a middle to late fifth dynasty date (Chapter 2.I.F.1).

Porter and Moss suggest (*loc. cit.*) that this man is the ḥ'-inpw shown as the son of ny-'nḥ-r' on statue Cairo, CG 62, and this would seem likely as both men hold the very rare title imy-r wd3 n nwb m prwy pr-'3. The vertical column of text in the central niche

- 1 Helck, *loc. cit.*; Another tomb with a large collection of very unusual titles, that of wr-nww (Davies et al., *Saqqara Tombs I*, 21-9), is unlikely to antedate the mid-sixth dynasty by virtue of its position in the Teti pyramid cemetery.
- 2 It is presumed that the following text, found at the end of the architrave, is to be interpreted as imy-r pr-ḥd, imy-r pr-'ḥ3w (compare the lintel of mry (58)):



also appears on the false door of ny-'nh-r'; the son did not follow his father's use of an offering list on the inner jambs of his door, which may represent the development of style of a generation, from the middle to the later fifth dynasty.

Suggested Date: Middle to late fifth dynasty.

h'-b3w-hnmw; biw 102

Source: Tomb east of the pyramid of Pepy II at South Saqqara, M 14.

Bibliography: PM 32, 684.

Relevant Titles: imy-r prwy-hd, imy-r hwt wrt 6, imy-r šnwty, imy-r k3t nbt, t3yty z3b t3ty.

Other Titles: im3-', imy-iz, imy-r izwy hkr nzwt, imy-r w'bt, imy-r wpt, imy-r pr nmtt nzwt, imy-r pr hry-wdb, imy-r prwy-nwb, imy-r r-3w, imy-r r-'3 mht, imy-r r-'3 rsy, imy-r h3swt nbt, imy-r hnty-š pr-'3, imy-r hry htm md3t, imy-r zš md3t, imy-r swt pr-'3, imy-r swt špswt, imy-r swt špswt pr-'3, imy-r sqbbwy, imy-r šm'w, imy-r šnw pr, imy-r gswy-pr, iry p't, iry nfr-h3t, mniw nhn, h3ty-', hry-tp nhb, hry-tp d3t, hrp i3t nbt ntrt, hrp šndyt nbt, hry-hb, hry-hb hry-tp, zš md3t ntr, sm, sm3 inpw, sm3 minw, smr w'ty, smsw snwt, sd3wty bity.

This tomb is immediately to the east of that of mry-r'-i3m (61), and h'-b3w-hnmw was considered by Jéquier, presumably on archaeological grounds, to have been his successor as vizier.¹ He is dated by Kees to the end of the reign of Pepy II,² and by Baer to the third to fourth quarters of that reign.³

Much depends on the interpretation of the reliefs in the mortuary temple of Pepy II. It would appear that h'-b3w-hnmw erased the name of an official and replaced it with his name biw and the title im3-'.⁴ Other men by the name biw are known from South Saqqara,⁵ but the title of im3-' was borne mainly by viziers at that time. Such replacement of original names in the temple shows that he was later than the period in which it was decorated.

It thus appears that three men who became vizier after the temple was built are depicted therein - mry-r'-i3m, šn'y (133) and h'-b3w-hnmw. On surviving evidence only the latter was not incorporated in some manner into the original scheme of decoration, and it is thus logical to date him later than the others. The non-appearance of the viziers ny-hb-sd-nfr-k3-r' (72) and tti (156) suggests that they were the latest of all the holders of this office in the reign of Pepy II.

1 ASAE 34 (1934), 76.

2 *Vezirat*, 47-8.

3 *Rank and Title*, 109 (361).

4 Jéquier, *Pepi II II*, pl. 57. The name biw has also been added without titles, *id.*, *ib.*, pl. 73, 88.

5 For example, the biw of tomb N 4, PM 32, 677.

Suggested Date: Third quarter of the reign of Pepy II.

ḥ'f-minw 103

Son of Khufu

Source: Tomb in the Eastern Cemetery at Giza, G7430 + 7440

Bibliography: PM 32, 195; incompletely published - examination of excavation records in Boston.

Relevant Titles: imy-r k3t nbt nzwt, t3yty z3b t3ty.

Other Titles: iry p't, [wr 5] pr-dḥwtj, [wtj] inpw ?, mniw nḥn, r p nb, ḥ3ty-', ḥry-sšt3 n iti.f, ḥry-sšt3 nzwt m

swt.f nbt, ḥrp 'ḥ, ḥt , ḥry-ḥb, ḥry-ḥb ḥry-tp, z3 nzwt, z3 nzwt n ḥt.f, z3 nzwt n ḥt.f smsw, zš md3t ntr, smr, smr w'ty, smr w'ty n iti.f, smr n iti.f.

The identity of the mother of ḥ'f-minw is uncertain, but his father was presumably Khufu. He and k3i-w'b (140) are the only sons of that king to be called z3 nzwt n ḥt.f smsw; he could then be the eldest son of one of Khufu's chief queens and one of the elder children of Khufu. He would probably have been among the first children to be considered for the vizierate. Like the owner of tomb G7310 + 7320 he was vizier at the time his tomb was decorated, unlike ḥ'f-ḥwfw (104) who was clearly promoted later in life. Features of the offering lists on his coffin, such as the presence of a linen list, suggest that it was made earlier than that of ḥ'f-ḥwfw, possibly in the reign of Djedefre or early Khafre.

Suggested Date: Reign of Djedefre to early reign of Khafre.

ḥ'f-ḥwfw 104 ('ḥ'f-ḥwfw I')

Source: 1. Tomb in the Eastern Cemetery at Giza, G7130 + 7140.

2. Statue of deceased found in the Temple of Isis at Giza, now Cairo, CG 46.

Bibliography: PM 32, 188-90 (including statue); see now, Simpson, Giza Mastabas III, 9-20.

Relevant Titles: (from statue) t3yty z3b t3ty.

Other Titles: 1. Before Vizierate (from tomb): iry p't, '3 dw3w, 'd-mr dp, w' wrw zh, wd-mdw n ḥry-wdb, mdw ḥp, ḥm b3w nḥn, ḥm-ntr ḥr qm3-', ḥm-ntr ḥwfw, ḥry-wdb m ḥwt-'nḥ, ḥrp 'ḥ, z3 nzwt, z3 nzwt n ḥt.f, smr w'ty, sd3wty bity.

2. When Vizier (from statue): iry p't, wr 5 pr-dḥwtj, z3 nzwt n ḥt.f, sd3wty bity.

That ḥ'f-ḥwfw was a son of Khufu is almost certain, coupling the location of his tomb with the representation of a queen, whose name

is lost, as his mother.¹ That she was ḥnwt-sn, the queen buried in pyramid G1c is possible, but is no means as certain as Reisner and Smith would believe (see further below, k3i-w'b (140)).

Reisner and Smith consistently date the completion of this tomb to the end of the reign of Khufu.² This is based solely on the date of rnpt zp 12 of an unnamed king found on some of the casing blocks, interpreted by Smith as 'Year 23' of Khufu.³ This example could equally be of the reign of Khafre, but, more importantly, need bear but little relation to the date of decoration of the mastaba.

The offering lists in the tomb represent what is probably the earliest attempt at ordering the elements of such a list into a regular form, and it has been argued above that a date in the reign of Khafre may be a possibility for the decoration of the chapel of ḥ'f-ḥwfw (Chapter 2.II.B).

If Reisner was correct and he was not the son of Khufu's chief queen, ḥ'f-ḥwfw may not have been born before the beginning of his father's reign (see page 7 above). He would then be at most in his early twenties on the death of his father, perhaps too young to start decorating a tomb. He is never called eldest king's son, which title was held by k3i-w'b (140) and ḥ'f-minw (103). On this basis also a date in the reign of Khafre would be suitable for the decoration of his tomb. His elevation to the vizierate happened after his tomb was complete, but was commemorated by the setting up of a statue in his chapel.

Suggested Date: Perhaps middle to late reign of Khafre.

ḥ'f-ḥwfw 105 ('ḥ'f-ḥwfw II')

Source: Tomb at the south end of the first row of mastabas in the Eastern Cemetery at Giza, G7150.

Bibliography: PM 32, 190; see now, Simpson, Giza Mastabas III, 21-27.

Relevant Titles: imy-r k3t (nt) nzwt.

Other Titles: imy-r mš', imy-r zt ḥ3swt imntt, w'b nzwt, wr md šm'w, nst ḥntt, ḥm-ntr ///, ḥm-ntr m3't, ḥm-ntr r' m st-ib-r', ḥm-ntr ḥwfw, ḥry-sšt3, ḥry-sšt3 n nb.f, z3 nzwt.

This tomb is next to that of ḥ'f-ḥwfw I (104), and it is not impossible that some sort of relationship existed between the two. However, the tomb is not part of the original cemetery. Texts on a pillar of the offering chapel are crucial to the dating of the tomb. Three columns of text describe ḥ'f-ḥwfw as im3ḥw ḥr three kings: Neweserre, Sahure and the third is unclear. Simpson initially reads it as im3ḥw ḥr ḥwfw, but points out that, as this

1 Simpson, *op. cit.*, fig. 26.

2 For example, Giza II, 8.

3 Simpson, *op. cit.*, fig. 35c; Smith, JNES 11 (1952), 127 (8).

expression tends to refer to a living king in the fourth and fifth dynasties, it would be unlikely that **h'f-hwfw** lived for almost one hundred years, and so it may be that the name is that of Menkaure.¹ One has then only to assume that these three kings are mentioned because they granted special favours to the tomb-owner.

The period from the beginning of the reign of Menkaure to that of Neweserre is probably about sixty years. Given that he would have had to have reached office-bearing age to be **im3hw**, he would have been quite old at the beginning of the reign of Neweserre and perhaps did not live long into it.

Suggested Date: Neferirkare to early reign of Neweserre.

h'-mrr-pth 106

Source: Tomb at North Saqqara, no. 68 (C 4).

Bibliography: **PM** 3², 481; also examination of false door in Cairo.

Relevant Titles: **imy-r hwt wrt, imy-r zš ' nzw, imy-r k3t nbt, imy-r k3t nbt nt nzw.**

Other Titles: **iwn knmwt, imy-r phw, imy-r gs-pr, mdw rhyt, nst hntt, hry-tp nzw, z3b 'd-mr.**

The chapel of this tomb consists only of a niche, dated to the middle of the fifth dynasty or slightly later (period VB) by Baer.² This false door, which does not have a cornice or torus moulding, has several interesting features. The panel depicts the deceased seated on the right, and is flanked by wide apertures. The lower lintel contains an offering list, and there are three narrow jambs with figures of **h'-mrr-pth** at the bottom. Osiris is invoked in the funerary formulae. The even lengths of the jambs suggest a stage intermediate between older and newer false door types in which some features of the new type were used and others, such as the cornice and torus, omitted (Chapter 2.I.B). The offering list on the false door suggests a date in the second half of the fifth dynasty, as does the orientation of the figure on the panel (Chapter 2.I.G.2).

h'-mrr-pth may be related to **spdw-htp**, owner of the nearby tomb 69 at Saqqara.³ A son of this name appears on the above false door, but the door in the tomb of **spdw-htp** would seem to be of an earlier type than that of **h'-mrr-pth** in its design and the types of offerings included on the panel (Chapter 2.I.G.1). It is possible that this **spdw-htp** may in fact be the father of **h'-mrr-pth**.

Suggested Date: Later fifth dynasty, probably no later than the reign of Djedkare.

1 **op. cit.**, 24, fig. 42; compare Baer, **Rank and Title**, 44-5.

2 **op. cit.**, 109 (363).

3 D 15 - **PM** 3², 481-2. For the possible relationships, see Grdseloff, **ASAE** 39 (1939), 389-92.

hwfw-htp 107

- Source: Rock-cut tomb in the cliff to the east of the Eastern Cemetery at Giza, LG 76.
- Bibliography: **PM** 3², 212; some improvements in readings from expedition records in Boston.
- Relevant Titles: **imy-r k3t nbt nt nzwt.**
- Other Titles: **shd w'b, shd dngw.**

This tomb cannot belong to one of the original or early phases of the cemetery.¹ The evidence for dating the tomb is somewhat meagre. The title sequences do not give a useful date; it is possible that the tomb may be of a similar period to that of the nearby one of 'nh-h'f-r' (G7948), of the middle fifth dynasty.²

Suggested Date: Perhaps mid-fifth dynasty or later.

hrw 108

- Source: Depicted in the Mortuary Temple of Pepy II at South Saqqara.
- Bibliography: Jéquier, **Pepi II II**, pl. 45.
- Relevant Titles: **t3yty z3b [t3ty].**
- Other Titles: No further titles known.

This vizier's depiction is located away from the other reliefs of officials in the temple, and may consequently be an addition during a later phase of the decoration of the temple. For a discussion of the dating, see above under ihy-hnt (16).

Suggested Date: Second quarter of the reign of Pepy II.

hnty-k3i; ihhi 109

- Source: Tomb in the Teti Pyramid Cemetery at Saqqara, to the north-east of the pyramid.
- Bibliography: **PM** 3², 508-11.
- Relevant Titles: **imy-r prwy-hd, imy-r zš ' nzwt, imy-r šnwty, imy-r k3t nbt nt nzwt, t3yty z3b t3ty, t3yty z3b t3ty m3'.**
- Other Titles: **im3-', imy-r i'-r nzwt, imy-r izwy hkr nzwt, imy-r pr-nzwt, imy-r prwy-nwb, imy-r niwt mr, imy-r**

hnty-š, imy-r hnty-š pr-'3, imy-r zš (z3), imy-r zšwy, imy-r swt špswt pr-'3, imy-r sšr, imy-r [stp-z3] pr-nzwt nb, imy-r sd3wty, imy-r šwy pr-'3, imy-ht hm-ntr dd-swt-tti, iry p't, w'b 200 mn-nfr-mry-r' ppy, wr idt, wty inpw, h3ty-', h3ty-'

1 Baer, *op. cit.*, 112 (374).

2 **PM** 3², 207-8.

m3', hm-ntr pr dhwty, hry wrw, [hry-sst3] n wdt-mdw nbt, hry-sst3 n pr-dw3t, hry-sst3 n m33t w', hry-sst3 n mdw ntr, hry-sst3 nzwt m swt.f nbt, hts inpw, hrp i3ts km, hrp nsty, hrp šndyt nbt, hry-hb, hry-hb m3', hry-hb hry-tp, hry-tp nzwt pr-3, zš md3t ntr, zš n z3 mn-nfr-mry-r' ppy, sm, sm3 inpw, smr w'ty, smr w'ty m3', šhd pr-nzwt, šhd hm-ntr mn-nfr-mry-r' ppy, s[hd] hm-ntr hwt-k3-3h[t], šhd hm-ntr dd-swt-tti, šhd db3t, sd3wty bity.

As one of the largest tombs around the pyramid of Teti, and also because of its proximity to the pyramid, it is likely that at least part of this man's career was spent under that king. The existence of the title šhd hm-ntr mn-nfr-ppy shows that his career extended into the reign of Pepy I as well. It is possible that he may have been vizier at the end of the reign of Teti, and continued to hold this title in the following reign, when he probably expanded his tomb.¹

Suggested Date: Late reign of Teti to early/middle reign of Pepy I.

hnty-k3w-hr 110

Source: False door found near the mastaba of ny-'nh-b3 (70) in the Wenis cemetery at Saqqara.

Bibliography: PM 3², 629-30; unpublished - personal examination of original and Gunn Mss.

Relevant Titles: imy-r hwt wrt.

Other Titles: iwn knmwt, mdw rhyt, hry-hb, hry-tp nzwt, z3 nzwt, smsw izt, smsw izt m prwy.

This false door has no features which are particularly useful for dating. The earliest tombs in the area do not antedate the reign of Pepy (see 3ht-htp; hmi (3), to which reign belongs the tomb of ny-'nh-b3). The smaller tombs are almost certainly later in date, when this cemetery had lost its special position as the burial place of the highest officials of the reign of Wenis. In view of this, the dates of Baer seem very probable.²

Suggested Date: Middle to late sixth dynasty.

hnmw; hnmw-nti 111

Source: Tomb west of the pyramid of Pepy II, South Saqqara.

Bibliography: PM 3², 686-7.

Relevant Titles: imy-r zš ' nzwt.

1 James, Khentika, 16-9.

2 Periods VID or F (middle reign of Pepy II or later), Rank and Title, 116 (394).

Other Titles: imy-r hnty-š pr-'3, h3ty-', hrp šndyt nbt, hry-ḥb hry-tp, sm, smr w'ty, t3ty-sktt.

The material from this tomb is very slight indeed, comprising a jamb of the false door (not illustrated), part of the head of a statue, and fragments of painted decoration from the burial chamber. None of this is particularly usable for dating purposes. All that can be said at present is that it belongs to the reign of Pepy II, because of its location in the necropolis surrounding his pyramid.

Suggested Date: Reign of Pepy II.

hnmw-ḥtp 112

Source: False door found west of the pyramid of Pepy II at South Saqqara, in the area of tomb M 15.

Bibliography: PM 3², 684.

Relevant Titles: imy-r prwy-ḥd, imy-r šrwty.

Other Titles: imy-r izwy hkr nzwt, imy-r zš[wy], imy-r swt špswt pr-'3, iry p't m3', iry nfr-ḥ3t, wty inpw, h3ty-', h3ty-' m3', hrp i3ts km, smr w'ty, sd3wty bity.

The provenance and the arrangement of this piece date it to the reign of Pepy II. It is difficult to date by comparison with other doors in the cemetery as the relative chronology of most of the officials has not yet been established. That a great deal of variation is possible may be seen from the two other doors found with it.¹

There are however two occurrences of a hnmw-ḥtp in the pyramid temple. One is in the decoration of the antechamber, among the line of officials following ihy-ḥnt (16), and the other is on a fragment from the north wall of the sanctuary.² The former holds the titles of h3ty-', sd3wty bity, smr w'ty and hry-ḥb, the latter just iry p't.

The name hnmw-ḥtp is not uncommon at South Saqqara,³ and it is quite possible that the temple may represent a different man. The titles therein, however, do fit the hnmw-ḥtp under discussion best of all, as he is the only one to bear iry p't and h3ty-'. Jéquier has noted that in the temple reliefs hnmw-ḥtp is preceded by a nhri,⁴ and the false door of a nhri was found together with that of hnmw-ḥtp, perhaps adding force to this identification. If so, these two men might well date to the period of, and that following, the construction of the temple.

1 Jéquier, Pepi II III, figs. 62, 64.

2 Respectively, *id.*, Pepy II II, pl. 57 and pl. 87.

3 Two further and presumably different hnmw-ḥtp 's are known from South Saqqara, PM 3², 678, 687.

4 *id.*, Pepi II III, fig. 62.

Suggested Date: Second quarter of the reign of Pepy II.

hnmw-nti 113

Son of sndm-ib; inti (120)

Source: Tomb in the Western Cemetery at Giza, G2374.

Bibliography: PM 3², 87; unpublished - examination of excavation records in Boston.

Relevant Titles: imy-r prwy-hd, imy-r hwt wrt 6, imy-r zš 'nzwt, imy-r šnwty, imy-r k3t nbt nt nzwt, t3yty z3b t3ty.

Other Titles: iwn knmwt, imy-r w'bty, imy-r prwy-nwb, iry p't, mdw rhyt, mdh qd nzwt m prwy, h3ty-, hry-sšt3 n wdt-mdw nbt nt nzwt, hry-sšt3 n nzwt, hry-tp nzwt, smr w'ty, shd hm-ntr dd-swt-tti.

hnmw-nti is depicted as a son of sndm-ib; inti in the latter's tomb,¹ and was thus a younger brother of sndm-ib; mhi (121). He was active in the reigns of Wenis and Teti, whose cartouches appear in the estate-names, and the name of Teti's pyramid is also found. Considering his relationship to the other members of the sndm-ib family and his probable age, it is perhaps unlikely that he lived long into the reign of Teti, possibly serving both kings as vizier.

Suggested Date: Later reign of Wenis to early reign of Teti.

zzi 114

Source: Tomb at South Saqqara, situated between the pyramids of Pepy I and Pepy II, exact position unknown, E 16.

Bibliography: PM 3², 689.

Relevant Titles: t3yty z3b t3ty.

Other Titles: imy-r hnty-š pr-'3, wr 5 [pr-dhwty] ?, h3ty-, hry wrw, hry-sšt3 n pr-dw3t, [hry-sšt3 nzwt] ? m swt.f nbt, hry-tp nhb, hnty-š mn-nfr-mry-r' ppy, hrp i3t nbt ntrt, hrp šndyt nbt, hry-hb, zš md3t ntr, sm, smr w'ty, shd hm-ntr mn-nfr-mry-r' ppy, shd hm-ntr mrt mry-r' ppy.

No plan of this tomb is available, and the only surviving monument is part of the false door. From the titles above, it will be seen that the tomb can be no earlier than the reign of Pepy I, and it has been dated to periods VIC to VIF by Baer.² Unusually for a sixth dynasty piece, the false door has wide panel apertures; there would seem to be no trace of a 'T'-shaped panel which would render it comparable to the examples found around the pyramid of Pepy II.

1 LD II, 77.

2 Merenre to middle reign of Pepy II, Rank and Title, 120 (414).

The employment of two jambs for the false door of a vizier is not usual in the sixth dynasty, but is nevertheless found (tomb of **r'-wr** (93)). The use of three columns of text per jamb is not attested for the viziers of Pepy II from South Saqqara, but is common among the examples from the first part of his reign (such as the doors of **mrri** (67) and '**nh-mry-r**' (33)), as well as **mhw** (69) from a slightly earlier period. All these features point to a date for **zzi** before the second half of the reign of Pepy II.

Suggested Date: Reign of Pepy I to early reign of Pepy II.

ztw 115

Source: Tomb at Saqqara, east of the Step Pyramid and south of the pyramid of Weserkaf, D 46.

Bibliography: **PM** 3², 577; some additional information, Spencer, **JEA** 68 (1982), 20-22, pl. II (2); also personal examination of tomb.

Relevant Titles: **imy-r zš ' nzw**t.

Other Titles: **imy-[iz] nhn**, **mniw nhn**, **mdh zš nzw**t, **mdh**  **m prwy**, **r p nb**, **h3ty-**' , **hm-ntr nhbt**, **hry-sšt3 n ///**, **hry-sšt3 n pr-[dw3t]**, **hry-[h]b**, **z3 nzw**t n **ht.f**, **smr w'ty**, **sd3wty bity**.

This tomb consists of an L-shaped chapel with a large false door in the western wall. The door has been badly damaged by fire, probably in modern times, and apart from the remains of texts, there are registers of offering bearers and butchers on the outer jambs. This latter feature is generally found on doors of the middle to later fifth dynasty, but certainly not in the sixth. Spencer (**loc. cit.**) suggests the same date.¹

Suggested Date: Middle to later fifth dynasty.

ztw (?) 115a

Source: Fragment of a fowling scene, provenance unknown, now Munich, Staatliche Sammlung Agyptische Kunst, Gl. 105

Bibliography: **Staatliche Sammlung Agyptische Kunst** 1976, 55 (34a).

Relevant Titles: **imy-r hwt wr**t.

Other Titles: **/// nzw**t, **wr md šm'w**, **nst hntt**, **z3b imy-r zš dd-swt-tti** ?, **[z3b] 'd-mr**, **sm3' wd'-mdw**.

The three signs



beneath the throw-stick of the

¹ Baer dates this tomb to the sixth dynasty (**Rank and Title**, 121 (419)), but it is felt that the above arguments are sufficient for this to be disregarded.

deceased are presumably an unusual form of the name ztw, normally written  .¹ Its provenance is almost certainly Saqqara,

whence come all memphite examples of the name of Teti in titles with the exception of the vizier hnmw-nti (113). The date is less sure, but the high quality of the depiction of the deceased parallels many examples from the reign of Teti, even though the texts have been carved with less care.

Suggested Date: Early sixth dynasty or slightly later.

s3bw; ibbi 116

Source: Tomb complex with pth-špss (probably his son) at North Saqqara, nos. 37-8 (E 1-2; H 3).

Bibliography: PM 3², 460-1.

Relevant Titles: imy-r k3t nbt nt nzwt.

Other Titles: imy-r w'bt, imy-r pr zkr, imy-r hwt zkr m swt nbt, imy-ht hm-ntr nfr-swt-wnis, imy-ht hm-ntr dd-swt-tti, w'b pth, wr hrp hmwt, wr hrp hmwt m prwy, wr hrp hmwt m prwy n hrw hb, wr hrp hmwt n hrw hb, wr hrp hmwt db3t, mhnk nzwt, hm-ntr pth, hm-ntr m3't m swt pt (for nbt ?) n hry-b3qf, hm-ntr r' m 3ht-r', hm-ntr r' m nbn-r', hm-ntr r' m st-ib-r', hm-ntr r' m šzp-ib-r', hm-ntr hwthr m swt nbt, hm-ntr hr m hnt wr, hm-ntr hr hnty-mdf, hm-ntr hnty-i3t.f, hm-ntr hnty-tnt, hm-ntr zkr, hm-ntr zkr m swt.f nbt, hm-ntr dd-špss, hry-sšt3, hry-sšt3 n nzwt m swt.f nbt, hry-sšt3 n ntr.f, hry-sšt3 n k3t nbt, hrp mhnk nzwt, hrp hmwt nbt, hrp sm, zš qd št3 n wdt-mdw, špss nzwt.

The outer jambs of the false door specifically date the texts to the reign of Teti. The title imy-r k3t nbt nt nzwt only appears on the door, perhaps implying that he received that position in the same reign. Baer places him in his period VIB which begins in the reign of Teti, making the second half of the reign the most likely date.²

Suggested Date: Middle to late reign of Teti.

s3bw-ptḥ; ibbi 117

Son of nḥbw (90)

Source: Burial in shaft G2381a in the Western Cemetery at Giza; also a few blocks remaining from his chapel.

1 There is a parallel to this position of the name in the tomb of 3ht-ḥtp (4) - Petrie-Murray, Memphite Tomb Chapels, pl. VI.

2 Rank and Title, 121 (421).

- Bibliography: Brovanski, *L'Égyptologie en 1979* II, 118; further information from excavation records in Boston.
- Relevant Titles: **imy-r k3t nbt nt nzwt, t3yty z3b t3ty.**
- Other Titles: **imy-r izwy hkr nzwt, imy-r w'bt, imy-r niwt mr ?, imy-r zšwy, mdḥ qd nzwt m prwy, h3ty-', ḥrp šndyt nbt, ḥry-ḥb, ḥry-tp nzwt, sm, smr w'ty, sd3wty bity.**

For the arguments concerning the date of this tomb, see above under **mry-r'-mry-'nh-ptḥ; ptḥ-šps; impy** (62). The only independent attestation for **s3bw-ptḥ** is in the tomb of **nhbw**,¹ and on current evidence it is impossible to decide which of the two sons of this man was buried in G2381a.

Baer's date does not agree with that derived here, and his discussion of the problem should be consulted.²

Suggested Date: Middle of the reign of Pepy II.

s'nh-n-ptḥ 118

- Source: Mastaba in the Cemetery en Echelon at Giza, immediately to the south of the complex of the **sndm-ib** family, G5520 (formerly G2342; LG 28).
- Bibliography: **PM** 3², 164; unpublished - examination of expedition records in Boston.
- Relevant Titles: **imy-r k3t.**
- Other Titles: **imy-r d3d3t, wr md šm'w, nst ḥntt, rh nzwt, [ḥm-ntr] m3't, ḥry-sšt3, ḥrp zš, z3b imy-r [zš], z3b 'd-mr, z3b šḥd zš.**

The key to providing an adequate date for this tomb may lie in its position relative to that of the **sndm-ib** family complex. According to Reisner, this mastaba consists of an original chapel of his type 5 with a north-south offering room and an addition to the east comprising a chapel of his type 7 with an east-west offering room.³ It is unclear when the original mastaba was built, but it is possible that the inspiration for the plan of the newer parts of the chapel may have come from the mastaba of **sndm-ib; inti** (120) which is most likely to have been the earliest examples of this offering room type in the Giza Necropolis (Chapter 2.II.D).

Suggested Date: Late fifth dynasty to early sixth.

snnw-k3i; kki 119

- Source: Tomb in the Western Cemetery at Giza, G2041.

1 Smith, *BFA* 56 (1958), 59, fig. 2.
 2 Rank and Title, 96, 292 (286B).
 3 Reisner, *Giza* I, 264 (2).

Bibliography: **PM** 3², 68; not fully published - further information from excavation records in Boston.
 Relevant Titles: **imy-r k3t nzwt**.
 Other Titles: **imy-r niwt 3ht-hwfw**, '**d-mr grgt**, **rh nzwt**, **hrp w'b nzwt**, **zš ' nzwt**.

Baer has noted that this tomb is earlier than most of the smaller ones in the same area, and also that **snnw-k3i** may appear in the reliefs in the tomb of **nfr** (84).¹ These and stylistic features caused him to assign the tomb to the early or middle fifth dynasty.² On the basis of the date suggested above for **nfr**, the early fifth dynasty would be the more likely. The chapel is one of a group distinguished by having two false doors (Chapter 2.II.C.1), between which is a depiction of the deceased seated below an offering list. This is an example of a type of layout which appears in the early fifth dynasty. **snnw-k3i** may be one of the first such examples, as the elements of his offering list are not separated into small compartments as in the later fashion. This criterion again favours the early fifth dynasty.

Suggested Date: Early fifth dynasty.

sndm-ib; **inti** 120



Source: Tomb in the Western Cemetery at Giza, G2370 (LG 27).

Bibliography: **PM** 3², 85-7; for estates, Málek, **GM** 13 (1974), 21-4; also additional information from excavation records in Boston.

Relevant Titles: **imy-r prwy-hd**, **imy-r hwt wrt 6**, **imy-r zš ' nzwt**, **imy-r šnwy**, **imy-r k3t nbt nt nzwt**, **t3yty z3b t3ty**.

Other Titles: **imy-r iz nzwt**, **imy-r pr 'h3w**, **imy-r prw msw nzwt**, **imy-r hkr nzwt**, **imy-r st nbt nt hnw**, **iry p't**, **mdh qd nzwt m prwy**, **h3ty-'**, **h3ty-' m3'**, **hry-sšt3 n wdt-mdw nbt nt nzwt**, **hrp zš**, **hry-hb**, **hry-tp nzwt**, **z3b 'd-mr**, **smr w'ty**.

From his biography it is clear that **sndm-ib** lived most of his life in the reign of Djedkare Izezi - he speaks of carrying out works for the king, and of receiving favours from him. Furthermore there are two letters from this king to **sndm-ib**, one of which is dated to **rnpt zp** 16.³ At one point the phrase **min hr izzi** is found which indicates that this part of the texts was composed in the reign of

that king.⁴ The same line has the signs } ^{|||}    ; this is

1 Reisner, *op. cit.*, pl. 30b.

2 Rank and Title, 126 (452a).

3 *Urk.* I, 63.11.

4 *Urk.* I, 59.12.

not the date it has been taken to be but refers rather to a period of five years, four months and three days.¹ The exact significance of this is not clear from the context - perhaps it may mean that he had been serving in his official capacity with the accompanying titles for this period of time.

The tomb was built after his death by his son **sn̄dm-ib; m̄hi** (121), in a period of fifteen months.² **m̄hi** obtained several agreements and pieces of tomb equipment from the king,³ who however is not named.

There is some evidence that this king may have been Wenis. Recent work by the Museum of Fine Arts expedition at Giza has revealed the presence of a cartouche of this king in the gap left by Lepsius above the head of a figure of **m̄hi**.⁴ This must imply that **sn̄dm-ib; inti** died at the earliest at the very end of the reign of Izezi. Consequently, he would have held his highest offices in the last part of the reign of that king. This is important for chronology, as **sn̄dm-ib; inti** is normally dated to the middle of the reign;⁵ it also indicates that the date of **rnpt zp 16** may be near the end of the reign.

Suggested Date: Later reign of Djedkare.

sn̄dm-ib; m̄hi 121

Son of **sn̄dm-ib; inti** (120).

Source: Tomb in the Western Cemetery at Giza, G2378 (LG 26); one block in Chicago, Field Museum of Natural History, 31705.

Bibliography: **PM** 3², 87-9; additional information from excavation records in Boston.

Relevant Titles: **imy-r zš ' nzwt, imy-r šnwty, imy-r k3t nbt nt nzwt, t3yty z3b t3ty.**

Other Titles: **iwn knmwt, imy-r w'btty, imy-r prwy 'h3w, imy-r prwy-nwb, imy-r hkr nzwt nb, imy-r sšr nzwt, iry p't, mdh̄ qd nzwt m prwy, h3ty-' , h3ty-' m3', [hry-sšt3 nzwt m] swt.f nbt, hry-tp nzwt, smr w'ty.**

sn̄dm-ib; m̄hi appears in the reliefs of his father's tomb, and is recorded in the biography as having built the tomb after his father's death, probably near the beginning of the reign of Wenis. Recent research by the Museum of Fine Arts expedition at Giza suggests that **m̄hi** placed his name over that of another son in the

1 Against Grdseloff, **ASAE** 42 (1943), 59.

2 **Urk.** I, 64.3; the mention of the time taken must surely be stressing the speed with which it was built.

3 For example, a sarcophagus, **Urk.** I, 65-6.

4 **Erg.**, Taf. XVIII; information courtesy of Dr. E. Brovarski.

5 For example, Baer, **Rank and Title**, 126 (455), which incidentally puts doubt on his division between periods VB and VC.

tomb of his father. The identity of this person is unknown, but is presumably an elder brother. This would consequently date m̄hi later in the reign of Wenis.

On the false door in his own tomb, he relates that he was im̄³h̄w h̄r both Djedkare Izezi and Wenis. The varying juxtaposition of these two royal names with m̄hi 's titles makes it unclear whether his highest offices were held in both reigns; on the preceding evidence it would seem unlikely that he did, although he may well have attained the rank of imy-r k̄3t nbt nt nzwt (held by all members of the family) before his father's death in the reign of Djedkare.

A date for the building of his tomb and the holding of his highest offices in the reign of Wenis would be in accord with Baer, who places him in his period VC,¹ although doubts have been cast on the exact division between this period and the preceding VB, for which see the discussion of sndm-ib; inti.

Suggested Date: Middle reign of Wenis.

sh̄tpw 122

Source: Chapel in the tomb of his son k̄3i-m-snw (144) in the Teti Pyramid Cemetery at Saqqara.

Bibliography: PM 3², 541.

Relevant Titles: imy-r šrwt, imy-r šrwtj.

Other Titles: imy-r swt h̄tpw df̄3w, w'b h̄'-b3w-s3h̄w-r', hm-ntr nfr-ir-k̄3-r', hm-ntr r' m st-ib-r'.

This chapel was constructed for sh̄tpw by his sons k̄3i-m-snw and w̄3š-pt̄h, and so it is reasonable to assume that the architectural and stylistic features as well as the title sequences represent the period of the sons' careers. Consequently, the major arguments for dating will be found below under k̄3i-m-snw.² sh̄tpw would thus date to the middle or later fifth dynasty.

Suggested Date: Middle fifth dynasty or later, perhaps even reign of Djedkare

sh̄m-'nh-pt̄h 123

Source: Tomb at the south-west edge of the Eastern Cemetery at Giza, G7152.

Bibliography: PM 3², 191; see now Badawy, *The Tombs of Iteti, Sekhem'ankh-Ptah and Kaemnofert at Giza*, 15-24.

Relevant Titles: imy-r zš 'nzwt, imy-r k̄3t nbt nt nzwt, t3yty z3b t3ty.

1 Rank and Title, 126-7 (456, 456a) - middle reign of Djedkare to middle that of Wenis.

2 cf. Baer, *op. cit.*, 128 (462).

Other Titles: **imy-r w'bt, imy-r w'bt pr-'3, mdw rhyt, r p nb, ḥ3ty-', ḥry-sšt3, ḥrp wsḥt, ḥry-tp nzwṯ, zš ' nzwṯ pr-'3, smr w'ty, sd3wty bity.**

This tomb is not part of the original layout of the cemetery, and must be of later date. However, its location is not dissimilar to that of **ḥ'f-ḥwfw** II (105) (probably reign of Neweserre), nor is the method of construction, both tombs employing massive stone blocks in a manner akin to that of the nucleus cemeteries. Thus it is possible that the two mastabas were constructed at about the same time, that of **ḥ'f-ḥwfw** perhaps being the earlier as it is nearer the older parts of the cemetery.

The false door is of the torus and cornice type, in many ways more similar to those at Saqqara than Giza, but the 'L'-shaped chapel is not the customary form for such a door - the east-west chapel is more frequently to be found. The vertical column of inscription at the rear of the central niche is a feature normally associated with doors of the middle to late fifth dynasty (Chapter 2.I.F.2). The use of raised relief for the door is also a fifth dynasty feature (Chapter 2.I.F.1), and the width of the apertures either side of the panel would suggest a date before the later fifth dynasty (Chapter 2.I.D). Finally, viziers from the middle of the fifth dynasty at Saqqara with this type of false door tend to have examples with three jambs (for example, **pḥ-n-wi-k3i** (45) and **ptḥ-ḥtp** I (49)); perhaps this is an early example (like that of **ty** (157) at Saqqara) which is a transitional form between the earlier doors without torus and cornice (for example, **w3š-ptḥ** (37)) and the above more developed pieces. The door of **shm-'nh-ptḥ** is by far the earliest such example known from Giza.

Suggested Date: Perhaps early to middle reign of Neweserre.

shm-'nh-ptḥ 124

Source: Tomb at North Saqqara, no. 20 (D 41); offering chapel now in Boston, Museum of Fine Arts 04.1760.

Bibliography: **PM** 3², 454-5.

Relevant Titles: **imy-r ḥwt wrt, imy-r zš ' nzwṯ, imy-r šnwty**¹

Other Titles: **iwn knmwt, wr md šm'w, wd-mdw m3' n ḥry-wdb, wd-mdw n ḥry-wdb, mdw rhyt, nst ḥntt, ḥm-ntr m3't, ḥm-ntr ḥr-3ḥty, ḥry-sšt3 n wdt-mdw nbt nt nzwṯ, ḥry-sšt3 n mdw št3, ḥrp wsḥt, ḥrp zš, ḥrp zš nb, ḥry-tp nzwṯ, z3b 'd-mr, zš wr md šm'w.**

This tomb has an east-west offering room, approached from a north-south corridor. This type of plan develops in the middle fifth dynasty and exists concurrently with the older types as well as

1 For the possibility that these titles may represent two separate parts of his career, see the writer's article in **GM** 77 (1984), 43-4 (b)

with the complex chapel, the latter of which is only found in the earliest instances with the very highest officials (Chapter 2.I.H). The false door does not seem to have a cornice or torus moulding, although with its use of narrower panel apertures and even length inscriptions on the jambs it certainly resembles the new type of door; this particular form seems to belong to the later fifth dynasty (Chapter 2.I.B).

Baer dates the tomb to periods VB-C or VIF.¹ It has been suggested above (*m3-nfr* (54)) that the basis of period VIF is incorrect, leaving the two earlier periods possible. The indications from the false door suggest VC (middle reign of Djedkare to middle reign of Wenis) to be the more likely.

Suggested Date: Perhaps reign of Djedkare or Wenis.

sh̄m-k3-r' 125

Source: Rock-cut tomb in the Central Field at Giza, in the cliff south-east of the pyramid of Khafre, LG 89.

Bibliography: *PM* 3², 233-4.

Relevant Titles: *t3yty z3b t3ty*.

Other Titles: *imy-iz, iry p't, '3 dw3w, wty inpw, h3ty-', hm [b3w] nhn, hry-sšt3 n iti.f, hry-sšt3 n pr-dw3t, hrp 'h, hrp ['h n iti].f ?, hrp zš n iti.f, hry-hb hry-tp, hry-hb hry-tp n iti.f, z3 nzwt n ht.f, z3 nzwt n ht.f smsw, smr w'ty, smr w'ty n iti.f, sd3wty bity.*

The dating of this tomb and the genealogy of *sh̄m-k3-r'* are relatively secure. He is called an eldest king's son, and gives a list in his tomb of the kings before whom he was *im3hw*: Khafre, Menkaure, Shepseskaf, Weserkaf and Sahure.² This suggests that he was born in the reign of Khafre, and as his mother was queen *hdt-hknw*,³ that king was probably his father. Likewise his tomb was decorated in the reign of Sahure, in which period he presumably died.

Suggested Date: Reign of Sahure and a little before.

sšt-htp; hti 126

Source: Tomb in the Cemetery en Echelon at Giza, G5150.

Bibliography: *PM* 3², 149-50.

Relevant Titles: 1. Before Vizierate: *imy-r k3t nbt nzwt*.
2. When Vizier: *imy-r k3t nbt nzwt, t3yty z3b t3ty*.

1 Reign of Neferirkare to middle reign of Wenis, or middle reign of Pepy II; *Rank and Title*, 128-9 (465).

2 Hassan, *Giza* IV, fig. 64.

3 *id., ib.*, fig. 62.

Other Titles: 1. Before Vizierate: ['d-mr] imw, wr md šm'w, wty inpw, rh nzwt, hry-sš3 n k3t nbt nzwt, hrp 'h, hry-hb, z3 nzwt n ht.f, smr, sd3wty ntr imw.
2. When Vizier: iry p't, '3 dw3w, w' m wrw hb, wr m3 iwnw, wr [md šm'w], [wty] inpw, hm-ntr wnw-r hnty minw, hm-ntr b3 'npt, hm-ntr b3stt, hm-ntr hr sth, hm-ntr šsmtt, [hts] inpw, hrp mrt t3-mhw šm'w, hrp tis bity, z3 nzwt n ht.f smsw, zš md3t ntr, smsw snwt.

sš3t-htp is not given the titles of vizier on the walls of his tomb, his highest office thereon being imy-r k3t nbt nzwt. The vizierial titles come from a nameless pair statue found in the serdab, and the difference between the two groups of titles has given rise to Junker's suggestion that the statue represents sš3t-htp 's parents.¹ However there is no reason why this statue should not belong to sš3t-htp, it having been placed in his tomb after the completion of the rest of the decoration.²

His tomb must however be dated to the period before he became vizier, and on stylistic grounds it may be grouped with tombs from the early fifth dynasty (Chapter 2.II.C.1). This date is in agreement with that of Baer, who places both the tomb and the statue in the early fifth dynasty, before the introduction of an organised system of ranking titles.³

Suggested Date: Early fifth dynasty.

sšmw 127

Source: Tomb at North Saqqara, LS 5.

Bibliography: PM 3², 492.

Relevant Titles: imy-r šnwty, imy-r k3t nbt nt nzwt, imy-r k3t nt nzwt.

Other Titles: imy-r izty ntr, imy-r 'prwy n imwwy '3, imy-r pr 'h3w, imy-r mš', imy-r hrpw n nfrw, w'b nzwt, hm-ntr r' m st-ib-r', hry-sš3, hry-sš3 n wdt-mdw nt nzwt, hry-sš3 n ntr.f, hrp izwt ntr, šhd w'b nzwt, šhd hm-ntr, sd3wty ntr, sd3wty ntr m imwwy, sd3wty ntr m imwwy '3.⁴

This chapel has a small east-west offering room with a false door at the end of a corridor. The small size of the chapel may represent an early stage in the development of the east-west type, the earliest examples of which belong to the middle of the fifth dynasty (Chapter 2.I.H). Such a date is also supported by the arrangement of the doorjambs, as there is a larger figure of the deceased on the outer ones than on the inner, a feature not found in the

1 Junker, Giza II, 188-93, Abb. 34, Taf. XXVa.

2 cf. Schmitz, Königsson, 73-5.

3 Rank and Title, 130-1 (473 and 473A).

4 This titulary can perhaps be divided into two parts - see below page 232.

later part of the dynasty (Chapter 2.I.B). His titles make a date before the reign of Neferirkare impossible, and his proximity to such tombs as that of pth-šps, ¹ might suggest he was no earlier than the reign of Neweserre.

Suggested Date: Middle fifth dynasty, perhaps reign of Neweserre.

^Ysšmw 128

Source and Bibliography: Seated statue in the Cairo Museum, CG 202, provenance unknown, but presumably (on stylistic grounds) from the Memphite region.

Relevant Titles: imy-r pr-ḥd.

Other Titles: None given

The quality of the carving of this statue is excellent, and is typical of many famous pieces of fifth dynasty date, for example, the statue of ty (157).² Without further evidence it is not possible to date the statue more precisely.

Suggested Date: Middle fifth dynasty or later (?).

^Ysšm-nfr 129 ('sšm-nfr I')

Source: Tomb in the Cemetery en Echelon at Giza, G4940 (LG 45).

Bibliography: PM 32, 142-3; publications checked with excavation records in Boston.

Relevant Titles: imy-r k3t nzw.

Other Titles: imy-r zš hryt-' nzw, imy-r sty df3w, wr md šm'w, [ny] ḥwt ḥr-ḥpr, rh nzw, ḥm-ntr inpw, ḥm-ntr ḥr qm3-', ḥm-ntr ḥqt, hry-wdb m ḥwt-'nh, hry-sš3, ḥrp 'h, ḥt ḥ3, hry-tp nzw, z3b 'd-mr, smr.

The title sequences of this man, according to Baer, violate the standard ones brought into use in the reign of Neferirkare, and in all probability the tomb was built before that reign.³ The scheme of decoration of the west wall discussed above (Chapter 2.II.C.1) adds support to the date from the title sequences. There it was suggested that this tomb is one of a group that show a reversal of the previous orientation of the principal figure of the deceased on the west wall, which in itself was a prelude to the alteration of the same figure from a standing to a seated position but retaining the same orientation. Such a feature would seem to date the tomb

1 PM 32, 464, securely dated to the reign of Neweserre.

2 Cairo, CG 20.

3 Rank and Title, 131 (476). This accords with Baer's independent dating, although this is based on an erroneous argument about the date of sšm-nfr III (131).

to the early fifth dynasty.

Suggested Date: Early fifth dynasty.

sšm-nfr 130 ('**sšm-nfr** II')

Source: Tomb in the cemetery en Echelon at Giza, G5080 (old 2200).

Bibliography: **PM** 32, 146-7; chapel almost completely unpublished - examination of excavation records in Boston.

Relevant Titles: **imy-r zš 'nzwt, imy-r k3t nbt nt nzwt.**

Other Titles: **imy-r pr 'h3w m prwy, hry-sšt3, hry-sšt3 n wdt-mdw nbt nt nzwt, hry-sšt3 n hryt-'nzwt, zš 'nzwt, zš 'nzwt n sb3yt nzwt, zš hryt-'nzwt.**

In reconstructing the **sšm-nfr** family tree, perhaps the greatest problem is the identity of the father of **sšm-nfr** II, since the obvious candidate, **sšm-nfr** I (129), had a wife with a different name (**imn-df3s**) from that of the mother of **sšm-nfr** II (**mrt-itis**). It is reasonably certain that **sšm-nfr** II was the father of **sšm-nfr** III (131), and from this may be dated approximately to the reign of **Neweserre**.

Junker believed that a scene from this tomb was copied from that of **iy-mry**,¹ and that there was some connection between the two may be shown by the presence of the estate **grgt-iy-mry** in the tomb of **sšm-nfr** II.² **iy-mry** is probably to be dated to the reign of **Neweserre**, which supports the date suggested above for **sšm-nfr**.

Suggested Date: Early in the reign of **Neweserre**.

sšm-nfr 131 ('**sšm-nfr** III')

Son of **sšm-nfr** II (130).

Source: Tomb in the Cemetery en Echelon at Giza, G5170. Chapel now in Tübingen, Ag. Inst. der Universität, Inv. 3.

Bibliography: **PM** 32, 153-4; for the chapel see now, Brunner-Traut, *Die altägyptische Grabkammer Seschemnofers III aus Giza*.

Relevant Titles: 1. Before Vizierate: **imy-r zš 'nzwt.**
2. When Vizier: **imy-r k3t nbt nt nzwt, t3yty z3b t3ty.**

Other Titles: 1. Before Vizierate: **imy-r prwy 'h3w, nst hntt, hry-sšt3 n wdt-mdw nbt nt nzwt, hry-sšt3 n nzwt, z3b 'd-mr.**

1 Junker, **Giza III**, 71.

2 See Baer, **Rank and Title**, 131-2 (477).

2. When Vizier: imy-iz, imy-r prwy 'h3w, h3ty-', hry-sšt3 n wdt-mdw nbt nt nzwt, hry-sšt3 n pr-dw3t, ht minw, hry-hb, z3 nzwt n ht.f, smr w'ty.

Baer has dated this tomb to the early part of the reign of Djedkare. He quotes the arguments of Grdseloff, who has however erred in reading rnpt zp 5 for rnpt 5 in the biography of sndm-ib; inti (120),¹ and consequently his succeeding argument loses much of its validity.²

Junker's argument for a date³ begins with the mastaba of d3ty (164) (G5370) which, as will be seen below, dates to the reign of Neferirkare or a little later. Against the rear wall of this was built the tomb of r'-wr I (G5270),⁴ and sšm-nfr III used r'-wr 's rear wall for his tomb. Allowing for a degree of separation in date, this places sšm-nfr in about the reign of Menkauhor. Furthermore, in the tomb of r'-wr II (G5470)⁵ was found a sealing of Djedkare. If this were a little later than the tomb of his brother, the reign of Djedkare would be a possible date for sšm-nfr III (as advanced by Grdseloff, but on erroneous grounds).

sšm-nfr received his promotion to the vizierate after most of the decoration of his tomb had been completed, perhaps placing his vizierate in the later of the two reigns mentioned above.

Suggested Date: Reign of Menkauhor to early/middle reign of Djedkare.

sšm-nfr; hb3 132

Source: Tomb west of the Step Pyramid complex at Saqqara, south of the group of tombs of the family of pth-htp I (49), E 8.

Bibliography: PM 32, 595; for some blocks see Aubert, Or 44 (1975), 1-11.

Relevant Titles: imy-r hwt wrt.

Other Titles: iwn knmwt, wr md šm'w, wd-mdw n hry-wdb, nst hntt, hm-ntr m3't, hm-ntr nfr-dd-k3-r', hm-ntr ntr-swt-mn-k3w-hr, hm-ntr hqt, hry-sšt3, hry-sšt3 n wdt-mdw, [hry-sšt3] n wdt-mdw nbt nt nzwt, hrp wsht, hrp zš hwt wrt, ht h3, hry-tp nzwt, z3b 'd-mr, zš n z3 nfr-dd-k3-r'.

Relatively little is known about this tomb except for the false door and some estates, and no plan of it has ever been published. Baer has dated it to period VB, in the reign of Djedkare.⁶ It is interesting that sšm-nfr may have usurped the tomb, but the extent

1 ASAE 42 (1943), 59.

2 Rank and Title, 132 (478).

3 Junker, Giza III, 13-4.

4 Probably a son of sšm-nfr I, PM 32, 158.

5 Probably a son of sšm-nfr II, PM 32, 162-3.

6 op. cit., 133 (482).

of this is unclear from the published material.¹ The false door has a torus moulding and three jambs with figures of the deceased at the bottom. A very unusual feature is the representation of the deceased standing on the panel, which may, albeit on very little evidence, be a feature of some false doors of the later fifth dynasty (Chapter 2.I.C).

The area of Saqqara in which the tomb of **sšm-nfr** was probably found does not seem to have been used before the time of the family of **pṯḥ-ḥtp** I (reign of Djedkare and after), supporting a late fifth dynasty date.

Suggested Date: Late fifth dynasty.

šn'y 133

Source: Tomb north-east of the pyramid complex of Pepy II at South Saqqara, N. 5.

Bibliography: **PM** 3², 678.

Relevant Titles: **t3yty z3b t3ty**.

Other Titles: **imy-r šm'w, iry p't, ḥ3ty-', sd3wty bity**²

This is the only tomb of a vizier in the north-east sector of this cemetery, those of the others being east of the pyramid. Kees placed him after **mry-r'-i3m** (61) in the second half of the reign of Pepy II.³ A man of the same name appears twice in the decoration of the mortuary temple. In the first occurrence he is **smr w'ty** and **hry-ḥb**, while in the second he is **smr w'ty**, with **t3yty z3b t3ty** added at a later date.⁴ Jéquier notes that the name is rather rare,⁵ and consequently it is almost certain that this is the same man as the tomb owner, who was of the rank **smr w'ty** when the temple was built, and was later promoted to the office of vizier. His position in the temple is thus similar to that of **mry-r'-i3m**. If, as Jéquier believed, the latter had the oldest tomb in the cemetery, it is likely that **šn'y** was his contemporary and immediate successor as vizier.

Suggested Date: Middle reign of Pepy II.

šdy-pṯḥ; šdw 134

Source: A false door and architrave from the Teti pyramid cemetery, exact position unknown. Architrave now in Rosicrucian Museum, RC 1737.

1 Aubert, **op. cit.**, 3-4.

2 Some are doubtless lost due to the damaged state of the tomb.

3 **Veziat**, 50-1 ("prj").

4 Respectively, Jéquier, **Pepi II**, II, pl. 59 and 73.

5 **op. cit.**, 50.

Bibliography: PM 32, 545; architrave to be published by the writer in JEA 71 (1985).

Relevant Titles: imy-r prwy-hd.

Other Titles: imy-r izwy hkr nzwt, imy-r wpt mn-'nh-nfr-k3-r' ppy, w'b 200 mn-'nh-nfr-k3-r' ppy, mty n z3, hry-sšt3 n pr-dw3t, šhd pr-'3, šhd pr-nzwt, šhd db3t.

One of the titles borne by šdy-ptḥ mentions the pyramid of Pepy II, and he is thus later sixth dynasty at the earliest. Most Old Kingdom monuments from the Teti Pyramid Cemetery date either from the beginning of the sixth dynasty through to perhaps the beginning of the reign of Pepy II (including all the large mastabas), or from the end of the Old Kingdom and First Intermediate Period, monuments of the intervening period at Saqqara coming largely from the area around the pyramids of Merenre and Pepy II. Mention of the pyramid of Pepy II in the Teti pyramid cemetery is very rare, and it is perhaps likely that these monuments are of the end of the sixth dynasty or later.

Suggested Date: End of Old Kingdom, possibly even First Intermediate Period.

q3r; mry-r'-nfr 135

Probably son of idw (23).

Source: Tomb north of the first row of mastabas in the Eastern Cemetery at Giza, G7101.

Bibliography: PM 32, 184-5; see now, Simpson, Giza Mastabas II, 1-18.

Relevant Titles: imy-r k3t nbt.

Other Titles: iwn knmwt, iwn knmwt m3', [imy]-r wpt htpw ntr m prwy, imy-r niwt 3ht-hwfw, imy-r niwt ntr-mn-k3w-r', imy-r hnw, imy-r zš n 'prw m pr[wy], mdw rhyt, hm-ntr m3't, hry-sšt3 n wdt nbt, hry-sšt3 n k3t nbt, hnty-š mn-nfr-mry-r' ppy, hry-tp nzwt, z3b imy-r zš, z3b imy-r zš n k3t nbt, z3b zš (from the tomb of idw), [zš] 'nzwt, zš 'nzwt hft-hr, zš 'nzwt hft-hr m3', smr w'ty, šhd w'b wr-h'f-r'.

The question of q3r 's relationships and possible date will be found above in the discussion of his father idw.

Suggested Date: Reign of Merenre to early Pepy II.

k3i 136

Source: Tomb at North Saqqara, no. 63 (D 19).

Bibliography: PM 32, 479.

Relevant Titles: 1. Before Vizierate: imy-r hwt wrt, imy-r zš 'nzwt, imy-r k3t nbt nt nzwt.

2. When Vizier: imy-r prwy-hd, imy-r hwt wrt 6, imy-r zš 'nzwt, imy-r k3t nbt nt nzwt, t3yty z3b t3ty.

Other Titles: 1. Before Vizierate: iwn knmwt, imy-r izwy nw pr md3t, imy-r izwy nw pr hry-wdb, imy-r izwy nw mrt, imy-r izwy nw hry htm md3t' nzwt, imy-r wpt nt nzwt, imy-r wsht, imy-r swt htpw df3w, wr md šm'w, wd-mdw n hry-wdb, mdw rhyt, mdh zš nzwt, nst hntt, hm-ntr m3't, hm-ntr hr qm3'-1, hm-ntr hqt, hm-ntr sd (?) hnty wsht.f, hry-sšt3 n wdt-mdw nbt nt nzwt, hrp zš iry sprw, ht h3, hry-tp nzwt, z3b 'd-mr, shd hm-ntr.

2. When Vizier: iwn knmwt, imy-r iz n 3ms, imy-r pr 'h3w, imy-r prwy-nwb, imy-r hrp zš 'nzwt, imy-r hrp zš nb m pr hry-wdb, imy-r hrp zš nb m mrt, imy-r hrp zš nb m rhyt, imy-r hrt, imy-r hkr nzwt m izwy, imy-r zš

(277), imy-r swt nbt nt i'-r nzwt, imy-r swt htpw df3w, imy-r sty df3w, mdw rhyt, hm-ntr m3't, hm-ntr hr mhyt, hm-ntr hr hry-ib 'h, hm-ntr hqt, hm-ntr sd, hry-wdb rhyt, hry-wdb hwt-'nh, hry-sšt3 n wdt-mdw nbt nt nzwt, hrp wsht, hrp zš [iry] sprw, hrp zš md3t, hrp zš nb, ht h3, hry-tp nzwt, hry-tp nzwt m prwy, zš wr md šm'w, shd wr md šm'w.

3. From either period: imy-r šm'w, hry-tp nzwt, z3b 'd-mr¹

Baer has dated this tomb on the basis of its title sequences to period VC, middle of the reign of Djedkare to middle reign of Wenis.² There are however reasons for preferring an earlier date. If one were to follow Baer, then k3i would be the only vizier of Djedkare to be buried in the northern cemetery at Saqqara, most of the others having tombs closer to the Step Pyramid.³ Neither of the two inscribed false doors in the tomb show the arrangement of features found in other viziers' tombs of Baer's period VC, which are of the newer pattern with a cornice and torus moulding, set in the west wall of an east-west offering chapel (Chapter 2.I.A and H).⁴ The door illustrated by Mariette exhibits some features which liken it to much earlier examples.⁵ The use of only two jambs either side of the central niche is unlike those of the viziers of Djedkare, as is the number of columns of inscription on them (four to five per jamb). Neither does there appear to be a torus moulding, although this is often not made clear in Mariette's publication. These features recall doors such as those of ny-'nh-shmt of

1 These titles (and imy-r zš 'nzwt) are found on the offering stands, Cairo CG 1299, 1302; it is not clear in which part of the tomb they originated (Mariette, Mastabas, 229). For an explanation of the two other divisions, see Strudwick, GM 77 (1984), 44 (c).

2 Rank and Title, 138-9 (505).

3 For example, r'-špss (95) and pth-htp I (49).

4 Such as pth-htp I (49), ph-n-wi-k3i (45), and sndm-ib; inti (120).

5 op. cit., 228.

the reign of Sahure,¹ and w3ꜥ-ptḥ; izi (37) of the reign of Neferirkare. The invocation of Osiris in the funerary formulae suggests that k3i is not as early as these two examples.

On the basis of these criteria, a date in the middle of the fifth dynasty preceding the common appearance of the newer type of false door would seem very likely.

Suggested Date: Middle fifth dynasty, perhaps early in the reign of Neweserre.

k3i 137

Source and Bibliography: An offering stand in Cairo, CG 57048, perhaps from Saqqara.
 Relevant Titles: imy-r prwy-ḥd, imy-r k3t nbt nt nzwt.
 Other Titles: imy-iz nḥn, iti minw, wd-mdw ḥry-wdb, ḥry-wdb m ḥwt-'nḥ, ḥry-sšt3 n pr-dw3t, ḥry-sšt3 n mdw ntr, ḥrp 'ḥ, ḥry-ḥb, smr, smr w'ty n mrwt.

The difference in titles suggests that this piece did not belong to k3i (136). It presents few useful dating criteria; most helpful is the form of the pr-ḥd group employed in the title imy-r prwy-ḥd, which is that most commonly found in the middle of the fifth dynasty (see below page 280).

Suggested Date: Perhaps middle of the fifth dynasty.

k3i-'pr 138

Source: Tomb in the cliff to the east of the Eastern Cemetery at Giza, G7814.
 Bibliography: PM 3², 205; virtually unpublished - examination of expedition records in Boston.
 Relevant Titles: imy-r k3t.
 Other Titles: imy-r pr ḥm-k3, rḥ nzwt.

The only inscription in this tomb is the poorly preserved drum over the entrance, and consequently there is little material usable for dating purposes. Many of the tombs in the vicinity seem to be of the fifth to early sixth dynasties, which may also apply to k3i-'pr.

Porter and Moss give as one of the titles of k3i-'pr that of 'Overseer of the Two Treasuries'. The title in question is written as in example A below, from Petrie's copy in the Sayce Manuscripts. Example B is taken from a photograph of the text in Boston (Expedition number B 8644), and shows that the signs in question are to be read imy-r pr ḥm-k3, or imy-r pr, ḥm-k3. The reading of this as a

1 Cairo, CG 1482.

treasury title would postulate an arrangement of the signs unparalleled in the Old Kingdom.

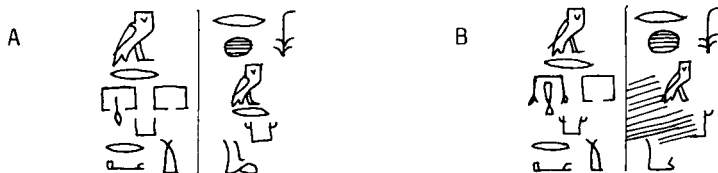

It is further probable that the drum of this tomb was also copied by Mariette, since if the drawing on *Mastabas*, 540 is reversed, the same texts are found as in the Boston photograph.

Suggested Date: Uncertain, perhaps middle fifth to early sixth dynasty.

k3i-'pr 139

Source: Tomb from Saqqara, exact provenance unknown, but probably from the Northern Cemetery.

Bibliography: *PM* 32, 501.

Relevant Titles: *imy-r k3t nzw*.

Other Titles: *iwn knmwt*, *imy-r mš'*, *wr md šm'w*, *wd-mdw* [*n hry-wdb*], *mniw s3bwt*, *nfr*, *hry-sšt3*, *hrp pr-ḥd*, *hrp st df3w*, *hrp tm3*, *z3b 'd-mr*, *z3b zš*, *z3b zš md3t*, *z3b šḥd zš*, *zš pr md3t*, *zš mrw s3bwt*, *zš mš' nzw m id3*, *zš mš' nzw m wnt*, *zš mš' nzw m htyw fk3t*, *zš mš' nzw m ḥ3swt imntt i3btt*, *zš mš' nzw m srr*, *zš mš' nzw m tp3*.

Fischer dates this tomb to the early fifth dynasty, principally by virtue of its similarity to tombs of that period at Giza.¹ In addition, the form and content of the offering list exhibit features which probably antedate the widespread adoption of the canonical offering list (Chapter 2.I.G.1).

He also discusses the possible relationships of *k3i-'pr* to other known officials;² the least likely, as he admits, is that *k3i-'pr* may be the son of *iy* (5). This latter man has been dated above to the second half of the fifth dynasty, which renders this identification rather improbable. None of Fischer's possible relationships are in fact definite enough to be used as firm criteria for dating.

Suggested Date: Early fifth dynasty.

1 *JNES* 18 (1959), 234.

2 *op. cit.*, 254-5

k3i-'h3f 139a

Source: Fragments of a false door found in tomb 7 at Dahshur, east of the northern pyramid of Sneferu.
 Bibliography: PM 3², 890
 Relevant Titles: [imy-r] k3t nt nzwt.
 Other Titles: /// m swt.f nbt, imy-r mš', imy-r hm-ntr, imy-r [h'(wy)]-snfrw, wr md šm'w, hm-ntr ? hr-snfrw ?, hm-ntr [snfr]w, hry-sšt3 n ///, hrp hm-ntr, z3 nzwt n [ht.f].

The dating of k3i-'h3f presents the same problems as that of several other king's sons buried at Dahshur, that is, although some features suggest the fifth dynasty, others point to a date associated with a resurgence of the cult of Sneferu in the late Old Kingdom. The tomb plan suggests the fifth dynasty, while the titles may indicate a late date.¹ The dating remains unclear; one wonders whether it is possible that some fifth dynasty tombs may have been usurped at the end of the Old Kingdom.

Suggested Date: Unclear; middle fifth dynasty or late Old Kingdom.

k3i-w'b 140

Son of Khufu

Source: 1. Mastaba in the Eastern Cemetery at Giza, G7110 + 7120.
 2. Statue, Cairo Museum JE 40431, found at Memphis, reinscribed by h'-m-w3st in the 19th dynasty.
 Bibliography: 1. PM 3², 187; see now Simpson, **Giza Mastabas III**, 1-8.
 2. PM 3², 864.
 Relevant Titles: t3ty z3b t3ty.
 Other Titles: imy-iz, iry p't, '3 dw3w, wr md šm'w, [w]r 5 [pr-dhwtj], h3ty-', hm-ntr srqt, hts inpw, hrp i3t nbt ntrt, hry-hb hry-tp, z3 nzwt, z3 nzwt n ht.f, z3 nzwt n ht.f smsw, smr w'ty n mrwt.

The title of vizier has not been found in the tomb, and so it is unclear whether he held the title while it was being constructed, although traces exist which may be the title wr 5 pr-dhwtj, only held by viziers. That k3i-w'b and the other individuals buried in the eight double mastabas between that of 'nh3f (34) (G7510) and the pyramids of the queens are children of Khufu is not doubted, either because of mentions of the parent(s) in the tombs, or because of the presence of titles with the tag n iti.f.

1 Respectively, Baer, **Rank and Title**, 139-40 (511A); Schmitz, **Königsson**, 150-1.

A damaged inscription in the tomb may be reconstructed to show k3i-w'b as the son of queen mrt-it \bar{t} is, a wife of Khufu;¹ her relationships may be established from the now lost stela discovered by Mariette.² It is usually assumed that she was the principal wife of Khufu and k3i-w'b the crown prince.³ One would not dispute the relationship between k3i-w'b and mrt-it \bar{t} is, but the assertion that he was crown prince is based solely on the location of the latter's tomb in the Eastern Cemetery, close to what is supposed to be the pyramid of the chief queen, who in turn is assumed to have been mrt-it \bar{t} is.⁴ Consequently k3i-w'b is presumed to have died before his father, which is by no means certain but is a logical conclusion if the previous assumptions are believed.

If the oldest burial in this group of mastabas is indeed that of k3i-w'b, then it somewhat contradicts the practice seen in the Western Cemetery that the earliest burials (in cemetery G4000 in particular) are usually those nearest to the nucleus mastaba. However it is also possible that the order of building in the Eastern Cemetery is different from that normally assumed (see above, 'nh-h3f (34)). Further problems arise from the arguments of Reisner and Smith, who believe the unnamed queen, the mother of h'f-hwfw I (104), to be hnwt-sn, the owner of the third queen's pyramid (G1c), because of the proximity of the tomb of h'f-hwfw to this pyramid.⁵ However this makes no allowance for the children of the queen (name lost) buried in pyramid G1b; Smith speaks of h'f-minw as being a son of hnwt-sn, and ddf-hr and the owner of G7310+7320 as being sons of mrt-it \bar{t} is by extension of the arguments given above.⁶

Consequently, one must be somewhat sceptical of these assumptions of family relationships based solely on tomb position. On grounds of age it is unlikely that k3i-w'b could have been vizier much before the end of the reign of Khufu, and if he were indeed crown prince, then the interesting possibility is raised that many kings may have been vizier before their accession. This practice is otherwise unattested in the Old Kingdom, and would certainly add many viziers to those already known. If as seems likely, he was promoted to the vizierate after the completion of the decoration of his tomb, the possibility of his being crown prince must surely be reduced, as he would not have prepared a tomb when he would have had to build a pyramid as king.

Suggested Date: Perhaps late reign of Khufu or slightly later.

-
- 1 Simpson, *op. cit.*, 3-4, fig. 13.
 - 2 Reisner-Smith, *Giza II*, fig. 8a.
 - 3 Simpson, *op. cit.*, *passim*; Reisner-Smith, *op. cit.*, *passim*.
 - 4 *id.*, *ib.*, 6.
 - 5 *loc. cit.*; Simpson, *op. cit.*, fig. 26.
 - 6 *op. cit.*, 7-8.

k3i-pw-inpw 141

- Source: Tomb east of the southern end of the Step Pyramid at Saqqara, D 57.
- Bibliography: PM 32, 579-80.
- Relevant Titles: imy-r zš [']-nzwt.
- Other Titles: iwn knmwt, wr md šm'w, mdw rhyt, nst hntt, hry-sšt3 n wdt-mdw nbt nt nzwt, hrp wsht, hrp zš iry sprw, hrp zš wsht, hry-tp nzwt, hry-tp nzwt wsht?, z3b 'd-mr.

This tomb seems to have consisted of two cruciform chapels with a niche between them. The only decorated (and published) false door was in the southern chapel, the only relief decoration in the northern. Somewhere in the tomb (location unclear from the publications) was a painting of a palace-facade false door.

Baer dates this tomb to period VIF.¹ However, it has been shown above (m3-nfr (54)) that his ranking chart for this period is highly suspect, and it should not preclude an earlier date. It is clear that m3-nfr and k3i-pw-inpw have not dissimilar titularies and may well be of similar date. The false door panel is inscribed with sixty-three elements of the canonical offering list. Such a feature seems to be found around the middle of the fifth dynasty and a little later (Chapter 2.I.G.2); other examples of such lists in cruciform chapels may be found in the tombs of šhm-k3i and hnmw-htp.² As published, the false door has only one pair of jambs, and the panel is flanked with wide apertures. The relief (except for that of the offering list) would seem to be raised. These features point to a fifth dynasty date, as are probably the other tombs in the same area east of the Step Pyramid.

Suggested Date: Middle to later fifth dynasty.

k3i-pw-inpw 142

- Source: Tomb from the area east of the Step Pyramid at Saqqara, exact position unknown, E 12.
- Bibliography: PM 32, 586.
- Relevant Titles: imy-r hwt wrt.
- Other Titles: iwn knmwt, mdw rhyt, nst hntt, hm-ntr m3't, hrp wsht, hry-tp nzwt, z3b 'd-mr.

The sum of our knowledge of this tomb is its plan and the titles from the false door. The plan has been compared to that of the vizier nfr-sšm-sš3t (89), probably from the same area.³ This is the only comparison to be made on the evidence currently available: nfr-sšm-sš3t probably dates to the middle of the sixth dynasty.

1 Middle of the reign of Pepy II; Rank and Title, 140-1 (515).
 2 Respectively, Murray, Saqqara Mastabas I, pl. VII; Cairo, CG 1423.
 3 Baer, op. cit., 141 (516).

Some relationship may have existed to the k3i-pw-inpw above (141) especially as a number of titles are common to both titularies. It would appear that plural strokes are found in this tomb, suggesting a date not early in the sixth dynasty.¹

Suggested Date: Perhaps middle sixth dynasty.

k3i-pw-r' 143

Source: Tomb at North Saqqara, no. 22 (D 39). Chapel now in Philadelphia Mus., E. 15729.

Bibliography: PM 32, 455-6.

Relevant Titles: imy-r pr-hd, imy-r pr-hd n hnw.

Other Titles: imy-ht pr-hd, wr bzt, ny z3 'prw nzwt ?, hm-ntr nfr-dd-k3-r', hry-sst3, z3 'prw nzwt, z3 hkr nzwt, shd z3 pr-hd.

The chapel is of the north-south type with, unusually, the entrance in the north wall. It is fully decorated, and there is a false door at the southern end of the west wall. It can date no earlier than the reign of Djedkare, whose name appears in the tomb. This door is one of a small group which have the deceased facing left on the panel and lintels and which may all be of similar date (Chapter 2.I.C and E.1); two of them, those of 'nh-m--r' and shm-'nh-ptj (124), are situated quite near that of k3i-pw-r'. The latter's false door does not appear to have a cornice or torus, and yet has three pairs of jambs with inscriptions of even length, and figures of the deceased at the bottom of each. Such features are perhaps to be considered as indicative of a transitional style between the older and newer false door types, evident in the later fifth dynasty (Chapter 2.I.B).

Suggested Date: Reign of Djedkare to end of the fifth dynasty.

k3i-m-snw 144

Son of shtpw (122)

Source: Brick-built tomb in the western part of the Teti pyramid cemetery at Saqqara.

Bibliography: PM 32, 541-2.

Relevant Titles: imy-r 3nwt.

Other Titles: /// b3-nfr-ir-k3-r', imy-r bh't nbt nt nzwt, imy-r bh't nt nzwt, w'b mn-swt-ny-wsr-r', w'b s3hw-r', rh nzwt, hm-ntr mn-swt-ny-wsr-r', hm-ntr nfr-ir-k3-r', hm-ntr r' m st-ib-r', hm-ntr r' hwthr m st-.

1 Mariette, Mastabas, 416.

ib-r', hry-tp šnw¹

This tomb was in fact built for at least three individuals: **k3i-m-snw**, **šhtpw**, and **wr-dd-ptḥ**, whose relationship to the other two is unclear. The question of the dating has been very much linked with that of the neighbouring tomb of the family of **k3i-m-ḥzt**,² due to the similar location, plan and construction.

When found, the tomb of **k3i-m-snw** was dated by its excavators to the period immediately preceding the construction of the tombs of **k3i-gmni** (151) and **mrrw-k3i** (68), although the reasons for this are not clear.³ Such a date has been rejected by Kees, principally for **k3i-m-ḥzt**, but also for **k3i-m-snw**.⁴ He compares particularly the similar position of the smaller mastabas north of the main group on this site, which are probably of the late reign of Pepy I. In his discussion Baer points out the evidence in favour of a late fifth dynasty date, but on the basis of the title sequences assigns it to period VID (early to middle reign of Pepy II).⁵

Thus the main problem is whether this tomb antedates or post-dates the construction of the major tombs in the cemetery. Firstly, although at first sight the location would seem to parallel that of the above mentioned small brick mastabas behind the major tombs, in fact those of **k3i-m-snw** and **k3i-m-ḥzt** are away to the south-west and west of them at a distance. These two tombs are also much larger than the other group. As it is built of brick, the mastaba of **k3i-m-snw** is unlikely to be a companion of the great tombs; its owner is also of lower rank, as the majority of the occupants of these large tombs were viziers. There is thus no reason not to see this area as a fringe of the main fifth dynasty cemetery at North Saqqara.

The discovery of a cylinder seal of Pepy I in the debris over the tomb of **k3i-m-ḥzt** cannot be used to prove a sixth dynasty date, as such a small object could have found its way there very easily over a long period of time.⁶ Perhaps more significant is the discovery of a sealing of Djedkare in one of the burials in the tomb of **k3i-m-snw**;⁷ while this cannot definitely prove a late fifth dynasty date, it is perhaps more likely that a proper burial incorporating such a sealing would not have been made very long after the reign of the king in question.

The design of the chapel and false doors points to the earlier date. The chapels of both mastabas have a hall leading to a cruciform offering room. Such a design is far more typical of the fifth than the sixth dynasty (Chapter 2.I.H), and it would appear that

- 1 Those of **hry-tp šnw** and **imy-r bh't nbt nt nzw**t come from the dedication inscription in the tomb of his father; they may perhaps belong to an earlier stage of his career.
- 2 **PM** 32, 542-3.
- 3 Firth-Gunn, **Teti Pyramid Cemeteries I**, 31.
- 4 **WZKM** 54 (1957), 98-100.
- 5 **Rank and Title**, 143-4 (528).
- 6 Quibell-Hayter, **Teti Pyramid**, 19.
- 7 Firth-Gunn, **op. cit.**, 36, 169 (7).

none of the other mastabas in the cemetery employ such a plan, but use rather the east-west offering room with the false door occupying the whole western wall. All these latter tombs also have false doors of the cornice and torus moulding type, which features are absent in the tomb of **k3i-m-snw** (no doors have survived in the tomb of **k3i-m-ḥzt**).

Suggested Date: Perhaps end of the fifth dynasty.

k3i-m-qdi 145

Source: Tomb at North Saqqara, LS 14.

Bibliography: **PM** 32, 494.

Relevant Titles: **imy-r pr-ḥd**.

Other Titles: **imy-r sšr nzwt, w'b nzwt, ḥm-ntr r' [m] st-ib-r', ḥry-sšt3.**

The only surviving decoration in the north-south offering room of this tomb is a false door. The chapel itself is unusual in that the entrance is from the south. Salient features of the false door are the panel apertures decorated with figures, and the abbreviated list of oils on the panel itself. The two features are indicative of the fifth dynasty, and the brief oil list is generally found about the middle of the period (Chapter 2.I.G.1).

Suggested Date: Perhaps early to middle fifth dynasty.

k3i-m-tnnt 146

Source: Tomb north of the enclosure wall of the Step Pyramid at Saqqara, no. 84 (D 7; S 919).

Bibliography: **PM** 32, 489; biography, Schott, *Fs Otto*, 443-61.

Relevant Titles: **imy-r k3t nbt nt nzwt.**

Other Titles: [**imy-irty**] '**prwy imw, imy-r wdt-mdw nbt nt nzwt, imy-r mš', imy-r sb3yt msw nzwt, z3 nzwt, smr w'ty, sd3wty ntr, sd3wty ntr m imwwy '3, dd nrw ḥr m ḥ3swt.**

The most important remains from this tomb are the damaged parts of a biographical inscription, in which there is a mention of a vizier **r'-špss**.¹ From the context it appears that **r'-špss** was active at the same time as **k3i-m-tnnt**, and is presumably the man of that name buried not far from the tomb in question (**r'-špss** (95)). That **k3i-m-tnnt** was the younger of the two is suggested by the relative lack of titles in his biography.² In general however, fifth dynasty biographies do not enumerate many titles, and so one should not base too many conclusions on the above observation. Support is

1 **Urk.** I, 183.12 and 17; Schott, *op. cit.*, 461c, Abb. 5.

2 *id.*, *ib.*, 452.

however given to this suggestion by Baer, who places k3i-m-t \bar{u} nt in period VC (middle reign of Djedkare to middle reign of Wenis)¹ and r'-šps in period VB (Neferirkare to Djedkare).

Suggested Date: Perhaps later reign of Djedkare.

k3i-ny-nbfwi; hnw 147

Source: A small tomb within the Temenos Wall of the mastaba of mrrw-k3i (68) in the Teti pyramid cemetery at Saqqara.

Bibliography: PM 3², 537.

Relevant Titles: imy-r šnwty.

Other Titles: imy-r šm'w, hry-tp nzwt.

There is a son of mrrw-k3i by the name of hnw mentioned in the former's tomb, but there are reasons for doubting whether this man is the same as k3i-ny-nbfwi; hnw.² Baer dates k3i-ny-nbfwi to the First Intermediate Period,³ admittedly on the evidence of very few titles.

The only elements to survive from this tomb are the false door and offering table. The door seems to be a typical late Old Kingdom product with a torus and cornice. The late date is emphasised by the elongation of the figures of the deceased. It is perhaps possible that the arguments concerning the location of the tomb of ttw (160) apply here, that in the Intermediate Period tombs may have been set up in close proximity to the great mastabas of the earlier period. Such a suggestion would explain the location of the tomb, and provide support for Baer's date.

Suggested Date: Late Old Kingdom to First Intermediate Period.

k3i-nfr 148

Source: Tomb at Dahshur, east of the northern pyramid of Sneferu, no. 28.

Bibliography: PM 3², 893; for Louvre E11268 see now, Ziegler, RdE 31 (1979), 120-34.

Relevant Titles: t3yty z3b t3ty.

Other Titles: iwn knmw, imy-iz nhn, imy-r wpt, imy-r h'-snfrw, iry p't, [w'] wrw hb, wr m3 iwnw, wr npt, wr 5 pr-dhwt, wd-mdw n [h]ry-wdb, mniw nhn, mdw rhyt, r p nb, h3ty-', h3ty-' n iti.f, hm b3w p, hm b3w nhn, hm-ntr wnw nzw, hm-ntr b3stt m swt nbt, hm-ntr hr mhyt, hm-ntr hr nb-m3't, hm-ntr hr nb msn, hm-ntr sbk mhyt ?, hm-ntr snfrw, hry-sst3 n pr-dw3t, hry-sst3 hr nb-m3't, hry-tp nhb, hts inpw, hrp 'h, hrp w'b, hrp hm-

1 Rank and Title, 144 (530).

2 Baer, op. cit., 115-6 (389a).

3 op. cit., 145 (533).

ntr snfrw, ht minw, ht hr, hry-hb, hry-tp nzwt, z3b 'd-mr, z3 nzwt, z3 nzwt n ht.f, z3 nzwt n ht.f smsw, sm3 minw, sm3 hr, smr, smr w'ty, smr n iti.f, smsw izt, sd3wty bity, sd3wty ntr imw.

The mid-fourth dynasty date given to this tomb by Baer among others is somewhat problematical.¹ Firstly, it is later than one would expect if k3i-nfr were a son of Sneferu as suggested by the inscriptions; secondly, the false door has more in common with those of the middle fifth dynasty (wide jambs with many columns of text and also a large figure of the deceased),² than those of members of the royal family of the fourth dynasty.

Recently Schmitz has proposed that, due to all the unusual features of the tomb, it should be dated to the late Old Kingdom, and that k3i-nfr 's tenure of the vizierate was wholly honorific.³ The main objections to this dating are the size of the tomb, which is more in keeping with those of the fourth or fifth dynasties, and the design of the false door. As the titles do not fit into any of the sequences of Baer, the tomb could postdate, as well as antedate, his principal periods, and so be of the late Old Kingdom, as is, for example, the tomb of ttw (160).

Suggested Date: Unclear; perhaps either late Old Kingdom or early to middle fifth dynasty.

k3i-htp 149

Son of 'nh-mry-r' (33)

Source: False door and reliefs in the courtyard of the tomb of mh̄w (69) in the Wenis Cemetery at Saqqara.

Bibliography: PM 32, 622; unpublished, but some titles in Martin, *Hetepka*, 5 (7); also personal examination of tomb.

Relevant Titles: t3yty z3b t3ty.

Other Titles: imy-r gs-pr, h3ty-', smr w'ty, shd hm-ntr mn-nh̄-nfr-k3-r' ppy, shd hm-ntr mn-nfr-mry-r' ppy, sd3wty bity.

Unlike those of his father, the reliefs of k3i-htp are clearly not part of the original scheme of decoration of the tomb of mh̄w. Assuming the above genealogy to be correct, he may be dated approximately one generation later than 'nh̄-mry-r', that is, about the middle of the reign of Pepy II.

Suggested Date: Middle of the reign of Pepy II.

1 Rank and Title, 145 (534).

2 The part now exhibited in the British Museum (BM 1324) is dated in the display to the fifth dynasty.

3 Königsson, 145-9, supported by Mostafa, *Opfertafel*, 54.

k3i-hr-ptḥ; ftk-t3 150

Source: 1. Tomb in the Western Cemetery at Giza, near the temenos wall of the pyramid of Khufu, G5560.
2. Lintel fragment found reused in tomb G7652 in the Eastern Cemetery.

Bibliography: 1. PM 32, 166-7. 2. PM 32, 201.

Relevant Titles: imy-r šrwty ?¹

Other Titles: [i]my-r inbw-hd, imy-r of the Letopolite Nome, [imy-r] niwwt m3wt nt nfr-dd-k3-r', wr md šm'w, nst hntt, hm-ntr m3't, hrp zš iry sprw, z3b imy-r zš, z3b 'd-mr, shd w'b 3ht-[hwfw].

The greater part of this mastaba has been badly damaged, and only the lower parts of the false doors have survived along with a few blocks. The tomb has a east-west offering room, although it would seem that false doors were used in another north-south room as well. In the burial chamber, on the east wall, is a depiction of the deceased seated before an offering list. Junker says that the introduction of the figure of the deceased into the burial chamber should be an indication of a late date.² However, there are virtually no examples with which to compare it, and so it should not be accepted without question. It can equally be argued that the decoration of one wall is an example of the progression from the simple list in the burial chamber of **sndm-ib; inti** (120) to the fully decorated chamber of **k3i-m-'nh**.³

Baer dates this tomb to period VI G,⁴ but the sequences are broken and not all in agreement. From the lintel in G7652 (not given by Baer), the title sequences would fit period VIC (mid sixth dynasty), more in accordance with the above argument concerning the burial chamber. Furthermore, the tomb is also located next to that of **idw I; nfr** (22), also probably to be dated to the middle of the sixth dynasty.

Suggested Date: Early to middle sixth dynasty.

k3i-gmni; mmi 151

Source: Tomb north of the temenos wall of the Pyramid of Teti at Saqqara, LS 10.

Bibliography: PM 32, 521-5.

Relevant Titles: imy-r prwy-hd, imy-r hwt wrt 6, imy-r zš 'nzwt, imy-r šrwty, imy-r k3t nbt nt nzwt, t3yty z3b t3ty, t3yty z3b t3ty m3'.

1 It is by no means certain that this title is present in the tomb, since it is damaged and published only in typeface.

2 Giza VIII, 3-4.

3 PM 32, 131-3.

4 End of the reign of Pepy II; Rank and Title, 148 (544)

Other Titles: /// št3t nt nzwt, im3-', imy-iz, imy-iz nhn, imy-r izwy hry htm md3t, imy-r izwy hkr nzwt, imy-r w'bt, imy-r wpt, imy-r wdt nbt, imy-r wdt-mdw nbt nt nzwt, imy-r prwy-nwb, imy-r n t3 [r] dr.f prwy, imy-r niwt dd-swt-tti, imy-r zš (²⁷⁷), imy-r sdmt nbt, imy-r šm'w, imy-r gswy-pr, imy-r t3-mhw šm'w, imy-r t3 r dr.f šm'w t3-mhw, iry p't, iry nfr-h3t, 'd-mr dw3-hr-hnty-pt, wr m3 iwnw, wty inpw, mniw nhn, r p nb, h3ty-', hry-sšt3, hry-sšt3 n wpt št3t, hry-sšt3 n m33t w', hry-sšt3 n mdw ntr, hry-tp nhb, hrp i3t nbt ntrt, hrp m ntrw, hrp hwwt nzwt, hrp hwwt nt, hrp hwwt nt hdt-nt, hrp šndyt nbt, hry-hb, hry-hb hry-tp, zš md3t ntr, sm, sm3 minw ?, smr w'ty, šhd hm-ntr dd-swt-tti, šhd dd-swt-tti, sd3wty bity.

For a fuller discussion of the date of this tomb relative to the others in this cemetery see above under mrrw-k3i (68) and nfr-sšm-r' (88). There is the fortunate survival in this tomb of a biography,¹ from which it would appear that he began his career under Djedkare, was a z3b 'd-mr in the reign of Wenis, and then continued to serve under Teti, in which reign he must have received the vizierate. The evidence discussed above under mrrw-k3i suggests that this latter promotion may have taken place in the early part of the reign.

Suggested Date: Early reign of Teti.

k3i-tp 152

Source: Various parts of a tomb chapel, from either Saqqara or Giza, now in London and Chicago.

Bibliography: PM 32, 693-4.

Relevant Titles: imy-r k3t nzwt.

Other Titles: 'd-mr grgt, 'd-mr grgt mhtt, w'b nzwt, rh nzwt, hm-ntr hfw, hrp w'b nzwt, hrp m z3, šhd w'b nzwt.

The provenance of these monuments is not certain. James believes Giza to be the more likely,² which would be strengthened by Fischer's suggestion of a relationship to another k3i-tp at Giza.³ On the basis of the titles, Kees has suggested a late fifth dynasty date.⁴

The simple form of the false door suggests that it may date to the fifth dynasty, supported by the appearance of offerings on the panel and the line of inscription in the central niche (Chapter 2.I.F.1). Such a simple form would be rather unusual for Saqqara,

- 1 Urk. I, 194-6; reconstruction, Edel, MIO 1 (1953), 210-26, Taf. I-11.
- 2 BM Stelae I², 5.
- 3 Varia, 35-7.
- 4 OLZ 57 (1962), 343-6.

making Giza the more likely provenance.¹

Suggested Date: Middle fifth dynasty (?).

k3i-dbh̄n 153

Source: Tomb in the middle of the Central Field at Giza.
 Bibliography: PM 3², 276-7.
 Relevant Titles: imy-r pr-h̄d (could also be imy-r pr-h̄d n 'prwy imw).
 Other Titles: imy-ht n pr-h̄d, ny 'prwy imw ?, rh̄ nzwt, h̄tm h̄3t df̄3w bity, zš̄ h̄bs nzwt, zš̄ h̄kr nzwt, sh̄d zš̄ pr-h̄d.

The offering chapel of k3i-dbh̄n has a false door in the centre of the western wall with the deceased and his wife to the right and funerary priests to the left. The false door is of the simple narrow type with two pairs of jambs, typical at Giza for much of the fifth and sixth dynasties (Chapter 2.II.E).

For unclear reasons, Baer has assigned this tomb to the sixth dynasty;² Again, indications for a date are vague, with a range of possible periods.

Suggested Date: Perhaps middle fifth to early sixth dynasty.

gmni-m-h̄3t; gmni 154

Source: Tomb immediately to the north of the temenos wall of the Pyramid of Teti at Saqqara, Hmk 30.
 Bibliography: PM 3², 538-9.
 Relevant Titles: imy-r š̄mwy.
 Other Titles: imy-r pr, mty n z3 w3d-swt-mry-k3-r', mty n z3 dd-swt-tti, rh̄ nzwt m3', smr w'ty, sd3wty bity.

As the name of king Merykare of the tenth dynasty is found in this tomb, the late First Intermediate Period or later is a certainty.

Suggested Date: Late tenth dynasty or later.

tp-m-'nh 155

Source: Tomb at North Saqqara, no. 75 (D 10, H 11).
 Bibliography: PM 3², 483.
 Relevant Titles: t3yty z3b t3ty.
 Other Titles: 1. Before Vizierate: imy-r wpt m3', h̄3ty-', hm-ntr nfr-swt-wnis, h̄ry-sš̄t3 n pr-dw3t, h̄ry-sš̄t3

1 Baer believes that the style of the pieces in Chicago is indicative of a relatively early date (Rank and Title, 150 (549)).
 2 op. cit., 150 (551).

nzwt m swt.f nbt, hry-hb, hry-tp nzwt, z3b 'd-mr m3', z3b zš m3', z3b shd zš m3', smr w'ty, smr w'ty m3', smr w'ty n mrwt m3', shd hm-ntr hwthr mrt wnis.

2. When Vizier: **h3ty-', smr w'ty.**

The chapel of this tomb exhibits the unusual combination of a north-south offering room with a false door of the cornice and torus type. These two features are normally mutually exclusive (Chapter 2.I.H), especially for a tomb that cannot antedate the reign of Wenis, as the titles show. Baer has dated the mastaba to his period VI E, the middle of the reign of Pepy II.¹

Further problems arise with the association of the owner of this false door with that of the elements of another false door found outside the tomb,² in particular because the panel of the latter door has wide apertures, which are not found after approximately the reign of Djedkare (Chapter 2.I.D). We would not expect **tp-m-'nh** to have used the current form of false door with narrow apertures before he became vizier and then revert to an older form after his promotion. However, it does not seem possible to disassociate these two sets of monuments according to the account of Mariette, their excavator,³ even though the stylistic features of Cairo, CG 1510 would be more in keeping with the nearby tomb of another **tp-m-'nh**, who is not otherwise known to have been vizier.⁴ We should perhaps regard the identification of these two groups of monuments as belonging to the same man with suspicion.⁵ For present purposes, if **tp-m-'nh** was vizier in the sixth dynasty, it is perhaps most likely that he held office in the period of the reigns of Pepy I to early Pepy II, when viziers were buried in no one particular area of the Saqqara cemeteries (cf. **idw I; nfr (22)**).

Suggested Date: Perhaps middle sixth dynasty ?

tti 156

Source: Tomb east of the pyramid of Pepy II at South Saqqara, M 15.

Bibliography: **PM** 3², 684.

Relevant Titles: **imy-r prwy-hd, imy-r zš 'nzwt, imy-r šnwty, t3yty z3b t3ty.**

Other Titles: **imy-r niwt mn-'nh-nfr-k3-r' ppy, imy-r niwt mn-nfr-mry-r' ppy, imy-r zš, imy-r gs-pr, imy-r gswy-pr, iry p't, iti ntr, '3 dw3w, wty inpw, h3ty-',**

1 Rank and Title, 151 (558).

2 Cairo, CG 1509-10.

3 Mastabas, 194.

4 Tomb no. 76 (D 11, **PM** 3², 483-4).

5 To anticipate conclusions reached below about the titles of viziers, the highest rank reached by **tp-m-'nh** was **h3ty-**, whereas one would expect him to have been **iry p't** in the sixth dynasty; **h3ty-** was however the highest rank of mid-fifth dynasty viziers (see page 307 ff).

hq3 b3t, hq3 hwt, hts inpw ?, hw-', hrp i3t nbt ntrt, hrp m ntrw, hrp šndyt nbt, hry-ḥb, hry-ḥb hry-tp, z3 nzwt, z3 nzwt smsw, zš md3t ntr, sm, smr w'ty, smsw snwt, sd3wty bity, sdt nzwt.

This man is dated by Kees and Baer to the end of the reign of Pepy II.¹ Kees's argument is based on the similarity of elements of his titulary to those of the viziers šm3i and idi of Koptos, who are known to have served under Pepy II and some of the kings of the eighth dynasty respectively. Although Baer places him in the same period (VIG - late reign of Pepy II) as ny-ḥb-sd-nfr-k3-r' (72), Kees's considerations suggest tti to be the later of the two.

Suggested Date: End of the reign of Pepy II.

ty 157

Source: Tomb at North Saqqara, no. 60 (D 22).

Bibliography: PM 3², 468-78.

Relevant Titles: imy-r zš ' nzwt, imy-r k3t nbt nt nzwt.

Other Titles: /// w't nt nzwt, /// m hnw 'ḥ-ntr šm'w, imy-r i'-r nb nzwt, imy-r i'-r nzwt, imy-r 'b nb, imy-r b3-nfr-ir-k3-r', imy-r phw, imy-r mn-swt-ny-wsr-r', imy-r hwt ihwt, imy-r hm-ntr, imy-r hm-ntr b3-nfr-ir-k3-r', imy-r ḥtp-r', imy-r ḥrt, imy-r ḥkr nzwt, imy-r ḥkr nzwt nb, imy-r zš

(²²³), imy-r sht-r', imy-r st-ib-r', imy-r šn-t3 nb, imy-r šzp-ib-r', iry nfr-ḥ3t, 'd-mr dw3-ḥr-ḥnty-pt, wr idt, hm-ntr ḥr inpw ḥnty pr smswt, hm-ntr ḥr qm3-', hm st, hry-wdb m hwt-'nh, hry-sšt3, hry-sšt3 n wdt-mdw nt nzwt, hry-sšt3 n pr-dw3t, hry-sšt3 n mdw ntr, hry-sšt3 n mdw št3 nw mdw ntr, [hry-sšt3] n nzwt m swt pr-'3, hry-sšt3 n nzwt m swt.f nbt, hry-tp nhb, hrp iri šn pr-'3, hrp iri šn nzwt, hrp 'h, hrp mḥnk nzwt, hry-ḥb, zš md3t ntr, zš n hryt-' nt nzwt, smr w'ty, smr w'ty n mrwt, šhd hm-ntr r' m st-ib-r'.

Size and magnificence of tomb and ease of dating do not always go together, as this example will show. The range of dates proposed may be indicated by that given by Porter and Moss, 'Neuserre to end of Dyn. V'. The lower limit is from Baer, who places him in period VC,² the upper because Neweserre is the latest king to be mentioned.

The plan of the offering rooms is a variant of the type with long north-south corridor and an east-west offering chapel. This design would seem to exist from the mid-fifth dynasty onwards (Chapter 2.I.H). The principal false doors are of the torus and cornice type, employing two jambs. They are in raised relief, with decorated apertures, and display a list of oils on the panel, all of which do not point to a date late in the fifth dynasty, but more

1 Respectively, *Veziat*, 48-9; *Rank and Title*, 152 (560).

2 Middle reign of Djedkare to middle that of Wenis, *op. cit.*, 152 (564).

towards the middle (Chapter 2.I.G.1). Such a mixture of old and new elements is seemingly unique, and as the false doors of his son and wife are of the older form without torus or cornice,¹ it is likely that ty's door precedes the development of a completely standardised version of the door with torus and cornice.

ty may appear in the decoration of the mortuary temple of Neweserre at Abusir. Borchardt lists a **smr w'ty** who may be this ty,² as he is most frequently represented in his tomb with the title of **smr w'ty**.

The names of kings must be used with care, but it is tempting to see in ty's titles continuous service for several successive kings. He held the title of **imy-r** of the sun temples of Sahure, Neferirkare, Neferefre and Neweserre. Only two of the known sun temples are not included here, that of Weserkaf (the earliest) and that of Menkauhor (the latest). Additionally, ty is the only person to have held any of these titles, and this uniqueness coupled with the continuous service (perhaps covering a period of only thirty years) suggests that he may have been contemporary with these rulers, and died before the establishment of the sun temple of Menkauhor. It should be remembered however, that this unique position could be equally explained by a sudden promotion to all four offices at once as a mark of favour, although the argument concerning Menkauhor would still be true.

Suggested Date: Perhaps late reign of Neweserre.

tnti 158

Source: Tomb at North Saqqara, no. 72 (C 18).

Bibliography: **PM** 3², 482.

Relevant Titles: **t3yty z3b t3ty**.

Other Titles: **iry p't, wr m3, h3ty-', hry-sšt3 n pt m33 št3 pt, hrp šndyt [nbt], hry-hb hry-tp, zš md3t ntr, sm, smr w'ty**.

The inscriptional material from this tomb is confined to the lintel of the doorway, and on that basis Baer gives periods VIB-D as possible dates.³ The majority of tombs in the North Saqqara Cemetery are of fifth dynasty date. The principal examples which would seem to belong to the end of the dynasty and later are those of **tp-m-nh** (155) and **s3bw; ibbi** (116). The former has a north-south chapel, as does tnti, combined with a torus and cornice false door. On the basis of such a comparison, tnti could date at least to the early sixth dynasty. The door lintel in his tomb has the unusual feature of a vertical column of text which interrupts the horizontal lines of the principal texts. A similar example may be found in the small tomb of **ny-nh-ppy** in the Wenis Cemetery at Saqqara which

1 Epron-Wild, *Tombeau de Ti I*, pl. XX, XXXIX.

2 *Ne-user-re'*, 71 (1, 2).

3 Early to middle sixth dynasty; *Rank and Title*, 153-4 (571).

is clearly later than the great mastabas there.¹ If the tomb of tnti is of the sixth dynasty, the most probable period is perhaps the reigns of Pepy I or Merenre, when the tombs of viziers were not built in any one particular area of the Saqqara Cemetery (compare mrrr (67)).

Suggested Date: Perhaps middle sixth dynasty.

ttti 159

Source: Tomb, exact location unknown, near the pyramid of Teti at Saqqara.

Bibliography: PM 3², 566-7; largely unpublished; much information from the Gunn Mss.

Relevant Titles: imy-r šnwty.

Other Titles: imy-r ʒht, imy-r pr hry-wdb, imy-r hry htm mdʒt, imy-r zš hry htm mdʒt, zš¹ nzw t hft-hr, smr w'ty, sdʒwty bity.

The material from this tomb comprises a false door, lintel and numerous statues. The false door has many similarities in shape and design with late Old Kingdom pieces from the same cemetery - it has a cornice and torus with an outer 'frame', although it does not have the 'I' shaped panel of many other doors from this area and also South Saqqara. As most of the material from the reign of Pepy II is to be found at the latter location ttti may perhaps date from the end of this reign at the earliest.

Suggested Date: Late sixth dynasty or later.

ttw 160

Source: Tomb in the angle between the mastabas of mrrw-kʒi (68) and kʒi-gmni (151) in the Teti Pyramid Cemetery at Saqqara.

Bibliography: PM 3², 537.

Relevant Titles: imy-r prwy-hd, imy-r hwt wrt 6, imy-r šnwty, imy-r kʒt nbt nt nzw t, tʒyty zʒb tʒty.

Other Titles: imʒ-, imy-iz, imy-r ʒht m tʒ-mhw šm'w, imy-r izwy hkr nzw t, imy-r w'bt, imy-r wpt htpw ntr m prwy, imy-r pr hry-wdb, imy-r hwt nwb, imy-r hnw, imy-r hry htm mdʒt, imy-r zšwy, imy-r swt špswt pr-ʒ, iry p't, ʒ dwʒw, 'nmt, 'hqʒt, 'd-mr dp, wr 5 pr-dhwty, wty inpw, mniw nhn, hʒty-, hm-ntr mʒ't, hry-sʒtʒ n wd'-mdw, hry-sʒtʒ n pr-dwʒt, hry-tp nhb,

1 Hassan, Saqqara II, fig. 3; this tomb is dated to the First Intermediate Period by Munro (SAK 10 (1983), 287-94). In fact the tomb itself may well be sixth dynasty, with the burial of the usurping ny-nh-ppy effected later (Fischer, JEA 65 (1979), 179).

ḥq3 b3t, ḥts inpw, ḥw-', ḥnty-š mn-nfr-mry-r' ppy, ḥrp i3t nbt nṛt, ḥrp i3ts km, ḥrp m nṛw, ḥrp nsty, ḥrp ḥwwt nt, ḥrp zš iry sprw, ḥrp šndyt nbt, ḥry-ḥb, ḥry-ḥb ḥry-tp, ḥry-tp nzwt, zš ' nzwt, zš md3t nṛ, sm, sm3 minw, sm3 ḥr, smr w'ty, smsw snwt, shd ḥm-nṛ mn-nfr-mry-r' ppy, sd3wty bity.

Two dates are frequently proposed for this tomb, namely the reign of Pepy I or later, and the First Intermediate Period. The former is suggested by the presence of the title shd ḥm-nṛ mn-nfr-ppy, and by the discovery of a jar lid of the same king in the burial chamber. The later date is from Baer.¹ The title is the main argument in favour of the earlier date, as such a small object as a jar lid could have come into his possession at any time. Most of the holders of this title would seem to date to the reigns of Pepy I or II.²

There are however a number of features which contradict such a date. It would appear that many of the smaller mastabas to the north of the principal ones date to the reign of Pepy I, and if ttw built his tomb in that reign, one wonders why he did not site it there. The actual position of his tomb is similar to that of the very many small tombs of the First Intermediate Period in the area between the great mastabas and the temenos wall of the pyramid complex, or indeed those of ḥtp and iḥy, both of Middle Kingdom date.³ Perhaps because of his importance in the First Intermediate Period, ttw was able to choose (or was granted) one of the prime sites for his tomb. The false door also argues against the earlier date. It has the 'T' shaped panel, which only seems to have come into common use in the reign of Pepy II, and continued at least to the tenth dynasty (Chapter 2.I.C).

It would appear that ttw has inflated his titulary using as a model the titles in the tomb of mrrw-k3i: to quote perhaps the best example, the title wr 5 pr dhwtj appears only four times after the fourth dynasty, twice here and twice at South Saqqara.⁴ Such borrowing is arguably a sign of a period that is looking back to former greatness, more true of the First Intermediate Period than the reign of Pepy I. Finally, although there is a lack of material for the title shd ḥm-nṛ mn-nfr-ppy in the First Intermediate Period, the cult of this king would certainly seem to have continued for the period in question.⁵

Suggested Date: Seventh to tenth dynasties.

- 1 Rank and Title, 154 (576).
- 2 For example, mḥw (69) at Saqqara, and several provincial officials.
- 3 PM 3², 550-1.
- 4 In the tombs of zzi (114) and hrdni, PM 3², 678.
- 5 Helck, MDAIK 15 (1957), 110.

dw3-n-r' 161

Source: Tomb in the Cemetery en Echelon at Giza, G5110.

Bibliography: **PM** 32, 148; almost completely unpublished - examination of excavation records in Boston.Relevant Titles: **t3yty z3b t3ty.**Other Titles: **imy-iz, iry p't, '3 dw3w, ['d-mr] imw, wr idt, [w]r 5 pr-[dhwty], wty inpw, mniw nhn, mdh z3**

nzwt, mdh , **r p nb, h3ty-', hm-ntr hr inpw hnty pr smswt, hry-wdb m hwt-'nh, hry-tp nhb, hw-', hrp i3ts km, hrp tis bity, hry-hb hry-tp, hry-tp nzwt m prwy, z3 nzwt n ht.f, z3 md3t ntr, sm3 ///**

Since the excavations of Reisner, it has been usual to identify **dw3-n-r'** with the son of queen **mrs-'nh** III by the name of **dw3-r'**.¹ Nowhere in these accounts is it mentioned that there is a difference in the writing of the names. This is an important objection, particularly in view of the seemingly clear differentiation of royal and non-royal cemeteries in the fourth dynasty. Reisner may have had in mind one unpublished piece of evidence from G5110;



there is one exception to the writing of the owner's name as **dw3-n-r'** on the panel of the false door, where (although broken) it seems to be written as shown here on the left. Given the consistency of the writing of the name elsewhere, it is possible to see this as an error, perhaps as a result of lack of space: the name is fitted into a relatively confined area above the head of the deceased and the signs are closer together than normal. The **n** may have been omitted due to the impossibility of finding space for it.

Porter and Moss refer to the son of **mrs-'nh** as 'Dua(en)re',² although assigning him to tomb G5110 without comment. More recently, Schmitz has observed that the other known children of **mrs-'nh** (**nb-m-3ht** (81) and **ny-wsr-r'**) are buried in the Khafre quarry cemetery.³ If **dw3-n-r'** is to be identified with **dw3-r'** one would expect, on the analogy of **nb-m-3ht** and **ny-wsr-r'**, to find titles with **n iti.f**, none of which are forthcoming.

In his reconstruction of the inscriptions of **ny-hmt**, Smith proposed to add the name of **dw3-n-r'** to those of **k3i-w'b** (140), **htp-hrs** II and **mrs-'nh** III.⁴ Examination of photographs of the original gives no support for the restoration.

If Reisner's theory about the parentage of **dw3-n-r'** is to be rejected, so also must his date in the reign of Menkaure. However, certain stylistic features of the western wall of the chapel indicate a similar date (Chapter 2.II.C.2), and it is suggested that

1 For **dw3-r'**, Dunham-Simpson, **Giza Mastabas I**, fig. 6; for Reisner's opinion, **Mycerinus**, 242 (7); **Giza I**, 218 (31); II, 11.

2 **PM** 32, 198.

3 **Königssohn**, 75-6.

4 Reisner-Smith, **Giza II**, 11 n. 13.

his status as vizier in the late fourth dynasty may have caused him to have used new and unique features in his tomb, along with older established ones.

Suggested Date: End of the fourth dynasty.

dw3-r' 162

Source: 1. Tomb east of the Southern Pyramid of Sneferu at Dahshur.
2. Statues found in the temple of the same pyramid.

Bibliography: 1. PM 32, 894. 2. PM 32, 878.

Relevant Titles: **imy-r k3t nt nzwt.**

Other Titles: **imy-r imntt, imy-r nzwtyw, imy-r hwt ihwt, imy-r h'-snfrw, imy-r h'wy-snfrw, imy-r z3w sm'w, 'd-mr dw3-hr-hnty-pt, w'b w'b-swt-wsr-k3f, wr md sm'w, rh nzwt, hm-ntr r' m nhn-r', hm-ntr snfrw, hry-s3t3, hry-s3t3 n nb.f, hq3 hwt-'3t, hnty-s, hnty-s w'b-swt-wsr-k3f, hrp w'b.**

From the general arrangement of chapels at Dahshur, it would seem that this is one of the earlier examples. Certain features of the false door give an indication of the date: on the panel appear most of the first twenty elements of the canonical offering list, which suggests the middle of the fifth dynasty (Chapter 2.I.G.2). This list is not unlike that of **ty**, probably of the reign of Sahure or slightly later.¹ The inner jambs are wider than the outer ones, and bear a large figure of the deceased, another feature of the first half of the fifth dynasty (Chapter 2.I.B). The use of sunk relief is generally uncommon on doors of this period, but since the tomb was completed by his son '**nh-m-'-r'**', this method may have been used to speed up the completion of the tomb.

Suggested Date: Middle fifth dynasty or slightly earlier.

d3-mrw 163

Source: Depicted amongst the courtiers of Pepy II in the antechamber and sanctuary of his mortuary temple at South Saqqara.

Bibliography: Jéquier, *Pepi II II*, pl. 59, 72.

Relevant Titles: **imy-r šnwty.**

Other Titles: **iry p't, h3ty-', smr w'ty.**

The name and titles of **d3-mrw** did not figure in the original decoration of the temple. In both cases his name has been added later: on the east wall of the antechamber (pl. 59), his name and the titles **iry p't, h3ty-'** and **imy-r šnwty** have replaced the name of

1 Cairo, CG 1380

another official who perhaps just held smr w'ty, while on the south wall of the sanctuary just the name has been changed (pl. 72), leaving the original smr w'ty intact. Consequently it is not certain whether this title really belonged to him.

The position of d3-mrw in these reliefs is not unlike that of h'-b3w-hnmw (102), that is, he was not included in the original scheme of decoration, and so his date could well be similar.

Suggested Date: Third quarter of the reign of Pepy II.

d3ty 164

Source: Tomb in the Cemetery en Echelon at Giza, G5370 (LG 31).

Bibliography: **PM** 3², 161; The false door of d3ty mentioned there as coming from G2337X is of a totally different man, see Simpson, **Fs Edel**, 489-90.

Relevant Titles: imy-r k3t nzw.

Other Titles: wr md šm'w.

The most important find in this mastaba was a wooden chest bearing sealings of lector priests of Sahure and Neferirkare. This does not necessarily mean that the burial was effected in the latter reign, but it is likely that the chest would have been placed in the tomb not long after the sealings were made. The serdab of r'-wr I was built against this tomb,¹ and if he were a son of sšm-nfr I (129), then the date of his tomb would perhaps be the reign of Neferirkare to Neweserre; the tomb of d3ty is a little earlier than this.

It is to be wondered whether he is the same man as the similarly-named son of d3ty (165) depicted in tomb G7810 at Giza (d3ty (166)). This man held the almost identical titles of imy-r k3t nt nzw and wr md šm'w, and the date to be suggested below on independent evidence would be in agreement with that noted above and renders such an identification possible.

Suggested Date: Perhaps the reign of Neferirkare, or a little later.

d3ty 165

Source: Tomb in the Eastern Cemetery at Giza, G7810.

Bibliography: **PM** 3², 204-5; almost completely unpublished - examination of excavation records in Boston.

Relevant Titles: [imy-r] k3t nbt nt [nzw].

Other Titles: imy-r mš', z3 nzw, z3 nzw n ht.f, smr ?.

1 Tomb G5270; **PM** 3², 158.

The parents of d3ty are completely unknown, although as a z3 nzwt n ht.f buried in the Eastern Cemetery at Giza there is a possibility that his parents were at the least the offspring of a king.¹ Tomb G7810 is part of the addition to the original mastabas of the cemetery, which consisted of the cores to the south and north of the mastaba of 'nh-h3f (34). One suspects that the southern group of tombs is the earlier, as it consists of more mastabas, construction moving to the area north of G7510 when space ran out.

The mastabas to the south of G7510 consist firstly of those of two queens, htp-hrs II and mrs-'nh III,² dating probably to the reigns of Khafre and Menkaure. htp-hrs was the wife of k3i-w'b (140) and later probably of Djedefre; mrs-'nh was her daughter by her first marriage, who then became the wife of (probably) Khafre. The other tombs in which the owners' names have survived are those of dw3-n-hr, 3ht-htp and mrt-itis, k3i-m-shm and ddf-minw.³ Of these people, dw3-n-hr, k3i-m-shm and ddf-minw were almost certainly true king's sons, as they bear titles with the tag n iti.f, and it is thus unlikely that they were sons of k3i-w'b as Reisner suggested;⁴ the king is not specified, but it must be Khufu.⁵ It is likely that mrt-itis was a daughter of Khufu who married a non-royal official; d3ty could be yet another of these children of Khufu.⁶

Stylistically, this group of mastabas is firmly in the tradition of the earlier ones in the cemetery (Chapter 2.II.C.2). If they all belonged to children of Khufu, it would be logical that they were very junior offspring, and so extra tombs had to be added to the original layout of the cemetery. None of these men was a vizier, although the evidence for any conclusions from these tombs is slight, and it is possible that by the time they attained a suitable age for such an office, the sons of Khafre had already established their claims. Such offering lists as survive from these tombs show mrt-itis having one of the old pattern with a linen list, while those of dw3-n-hr and d3ty represent a stage between that and the new form using the canonical list type (Chapter 2.II.B). As less important members of the family, they were perhaps less likely than viziers (h'f-hwfw I (104)) and queens (mrs-'nh III) to use the newest developments in tomb design, but stayed

- 1 Reisner suggests mrs-'nh II as his mother for no clear reasons; Giza I, 209 (34).
- 2 Tombs respectively, G7350, **PM** 32, 193; G7530 + 7540, **PM** 32, 197-9.
- 3 Tombs respectively, G7550, **PM** 32, 200; G7650, **PM** 32, 200-1; G7660, **PM** 32, 201-2; G7760, **PM** 32, 203-4.
- 4 For example, Giza I, 208-9; his reasoning is uncertain, but it may be due to their proximity to the tomb of mrs-'nh III, certainly a daughter of his.
- 5 The sons of Khafre are buried in the quarry cemetery east of the second pyramid, and the one certain son of Menkaure in the Menkaure Quarry cemetery.
- 6 A similar argument may be applied to iy-nfr of tomb G7820; **PM** 32, 205.

with the current ones for a time. The tomb of d3ty shows the deceased and wife seated opposite each other on the panel of the false door, an arrangement not previously encountered in the Eastern Cemetery, and perhaps indicating a later example.

On this basis, assuming d3ty to have been born in the later part of the reign of Khufu, his tomb and period of office-holding may be dated to the end of the fourth dynasty.

Suggested Date: End of the fourth dynasty.

d3ty 166

Son of d3ty (165)

Source: Represented in the tomb of his father in the Eastern Cemetery at Giza, G7810.

Bibliography: None - examination of unpublished material in excavation records in Boston.

Relevant Titles: imy-r k3t nt nzwt.

Other Titles: wr md šm'w.

On the basis of the date decided above for his father, d3ty presumably dates to the early part of the fifth dynasty, perhaps the reign of Neferirkare. For a possible connection between this man and the similarly-named owner of tomb G5370 at Giza, see d3ty (164).

Suggested Date: Perhaps reign of Neferirkare.

df3wi 167

Source: Tomb at North Saqqara, no. 55 (D 25).

Bibliography: PM 3², 466.

Relevant Titles: imy-r pr-ḥd, imy-r pr-ḥd n ḥnw, imy-r prwy-ḥd.

Other Titles: imy-r iz [ḥkr] nzwt, imy-r prwy-nwb, imy-r swt df3w, imy-r sšr nzwt, wr bzt, ḥm-ntr [ny-ws]r[-r'], ḥm-ntr rnnwtt ḥntt ḥ3t ḥt, ḥry-sšt3, zš n ḥryt-' nt nzwt.

This tomb has a small squarish offering room, the only decoration of which is on the false door. This decoration includes butchers and offering bearers as well as the usual inscriptions.

Baer can give no more precise date than the middle fifth dynasty or later,¹ based on df3wi 's priesthood of Neweserre, and thus the false door is left as the main item usable for dating. There is only one example which is somewhat similar, that of šḥm-k3i.² The jambs of the latter door are larger, and there are more items in

1 Rank and Title, 157 (594).

2 Murray, Saqqara Mastabas I, pl. VII.

the offering list on the panel. Such wide jambs are a feature of fifth dynasty doors (Chapter 2.I.B), and panel offering lists also indicate the same date. The inscriptions of sh̄m-k3i invoke Osiris and those of df3wi do not, although this need not make df3wi the earlier.

The owner of this tomb should thus be dated to the period between the reign of Neweserre and the later fifth dynasty, preceding the acceptance of the false door with torus and cornice false door as the principal form.

Suggested Date: Mid-late fifth dynasty.

ddf-ḥr 168

Son of Khufu

Source: Tomb in the eastern cemetery at Giza, G7210 + 7220.

Bibliography: **PM** 3², 191; incompletely published - examination of excavation records in Boston.

Relevant Titles: imy-r k3t [nbt nt nzwt].

Other Titles: imy-iz, 'd-mr imw, mniw nḥn, ḥ3ty-', z3 nzwt n ht.f, s[mr] w'[ty].

ddf-ḥr was presumably a son of Khufu, on the analogy of the neighbouring tombs. That his mother was the queen buried in subsidiary pyramid G1a is a speculation of Reisner's, and is perhaps best disregarded (see above under k3i-w'b (140)).

Reisner and Smith have argued that ddf-ḥr may have been dead by the beginning of the reign of Khafre, based on the assumption that the damage done to the tombs in the northernmost row of nucleus cemetery G7000 - those of k3i-w'b, ddf-ḥr and the unnamed owner of G7310 + 7320 (170) but particularly to that of ddf-ḥr - was as a result of a persecution by Djedefre, who may have executed some of these men.¹ There is no support for this romantic speculation, and Junker has suggested that the damage done to the tomb of ddf-ḥr occurred after the end of the Old Kingdom.² A further possibility arises from the association between Djedefre and ddf-ḥr proposed by Altenmüller, namely that his tomb was defaced together with the pyramid of that king, perhaps in the reign of Khafre.³ One would have to assume that ddf-ḥr was dead by that time.

Two problems arise from this: firstly, Junker argues that if the tomb was defaced in the fourth dynasty, the likelihood of the existence of his cult in the sixth dynasty is reduced (**loc. cit.**), and secondly, it is stated in the Book of the Dead (Chapters 30, 64, 148) that ddf-ḥr was alive in the time of Menkaure. The first argument may be overcome by seeing a restitution of the cult of

1 Giza II, 8.

2 Giza VI, 26; **Fs Rosellini**, **Studi** II, 137 ff.

3 **CdE** 45 (1970), 232-5.

ddf-hr in the fifth dynasty (a time perhaps better predisposed to him), and the second by treating the funerary literature with the customary caution as to their historical accuracy.

The remains of the false door of ddf-hr, with its carved representations of offering stands on the jambs, resemble that of h'f-hwfw I (104), probably to be dated to the reign of Khafre.

Suggested Date: Middle reign of Khafre or later, perhaps even early reign of Menkaure.

ddf-hnmw 169

Source: Rock-cut tomb to the east of the Eastern Cemetery at Giza, G7711a.

Bibliography: PM 3², 202.

Relevant Titles: imy-r k3t nzwt.

Other Titles: wr md šm'w, rh nzwt, z3 nzwt.

The evidence for dating this tomb is very slight. Baer has pointed out that ddf-hnmw can hardly have been a son of one of the fourth dynasty kings, and suggests dates that cover both the fifth and sixth dynasties.¹ The other tombs of important administrative officials which were also not part of the original cemetery are of fifth dynasty date, including notably another king's son, h'f-hwfw II (105), which suggests a possible date for ddf-hnmw.

Suggested Date: Early to middle fifth dynasty ?

Name Lost 170

Probably son of Khufu

Source: Tomb in the Eastern Cemetery at Giza, G7310 + 7320.

Bibliography: Unpublished - examination of excavation records in Boston. See also Simpson, Fs Edel, 492-3.

Relevant Titles: imy-r k3t [nbt nt] nzwt, t3yty [z3b t3ty].

Other Titles: imy-[iz], [imy-r] wsht, iry p't, '3 dw3w, wr 5 [pr-dhwty], mniw nbn, [r p] nb, h3ty-, [hm-ntr] wnw-r [hnty minw], hm-ntr b3 'npt, hm-ntr b3stt, hm-ntr spdw, hrp 'h.

The only reasonably certain fact about this man is that he was a son of Khufu; as discussed above under k3i-w'b (140), the identity of his mother is very uncertain. Reisner was inclined to assign this tomb to the b3wf-r' mentioned in the Westcar Papyrus.² Simpson (*loc. cit.*) suggests that this mastaba belonged to a b3-b3f or

1 Rank and Title, 158 (596).

2 cf. Reisner-Smith, Giza II, 7.

hnmw-b3f. The only trace that survives which could have formed part of a name is a ram (**b3** or **hnmw**), but this sign could be an element of a title such as **hm-ntr b3 'npt** which is attested elsewhere in the tomb, or it could belong to an entirely separate person - the proximity of the title **hm-k3** to one occurrence of the sign may suggest this.¹ Along with **h'f-minw** he is the only man in this group of tombs to be called vizier in the inscriptions of the tomb itself. Assuming no vast difference in the age of these tomb-owners and that the tombs were all built at an approximately similar time, his may be one of the earlier ones, conceivably dating to the reign of Khafre.

Suggested Date: Perhaps early reign of Khafre.

Name Lost 171

Source and Bibliography: A seated statue from Saqqara, exact provenance unknown; now Cairo, CG 49.
 Relevant Titles: **imy-r pr-hd n hrw**.
 Other Titles: **wr bzt, hm-ntr ///**

The publications suggest that this piece is of fifth dynasty date. It is unlikely to have been early in that dynasty, when few tombs were built at Saqqara. The traces visible of the **pr-hd** group suggest the form  in use before the later part of the fifth dynasty (see below page 280).

Suggested Date: Middle fifth dynasty or later.

Name Lost 172

Source: Three blocks in the Metropolitan Museum, New York, MMA 04.2.4-6, possibly from Saqqara.
 Bibliography: **PM** 3², 760; to be published by the writer in **JEA** 71 (1985).
 Relevant Titles: **imy-r pr-hd n hufw, imy-r pr-hd n snfrw, imy-r pr-hd ddf-r'**.
 Other Titles: **imy-r iz ///**, **zš ' nzwt**.

The variety of kings mentioned on these blocks raises the possibility that they may not have come from Saqqara. The criterion most useful for dating is again the form of the **pr-hd** group (),

1 This is unlikely to be the title **hm-k3** (name of tomb-owner), as priests do not seem to be so named on wall scenes in Old Kingdom tombs.

suggesting a date no later than the later fifth dynasty (see below page 280).

Suggested Date: Perhaps middle to late fifth dynasty ?

Name Lost 173

Brother of **nhbw** (90)

Source: Mentioned in the biography of his brother.

Bibliography: **Urk.** I, 216-7.

Relevant Titles: **imy-r k3t.**

Other Titles: **imy-r qd, mdh qd nzwt, mdh qd nzwt m prwy, smr w'ty, shd qd.**

In his biography, **nhbw** describes himself as serving alongside his brother as the latter proceeded through the above offices. The only possible indication of his identity is a relief from the tomb of **nhbw** with the relief of a brother named **ppy-mry-ptb-'nh**, although it is unknown whether this is the same brother as in the biography.¹ This brother was clearly senior to, and thus probably older than, **nhbw**; on the date given above for the latter, this brother would have held office in the middle of the reign of Pepy I.

Suggested Date: Middle of the reign of Pepy I.

1 Dunham, **JEA** 24 (1938), 7; a brother, whose name is lost, is shown in a marsh scene in this tomb - Smith, **BMFA** 56 (1958), 59, fig. 2.

PART III

Six High Administrative Titles of the Old Kingdom

Introduction to Titles

Each of the following chapters is in two parts, a discussion of the most common forms of the title in question and the titularies of the officials holding them, and a study of the wider functions of the particular office and the administrative department with which it was concerned.

The titularies of the viziers who held the title that forms the subject of the chapter will be discussed separately from those of the non-viziers. Study of the titularies of viziers shows them to have a greater number of more important titles of almost all types than the majority of non-viziers. Out of a total of about 2600 titles for 176 officials relevant to this work, approximately 1410 of them belong to 67 viziers. A non-vizier would rarely hold more than two of the five offices *imy-r ḥwt wrt*, *imy-r zš ' nzw*, *imy-r k3t nbt (nt) nzw*, *imy-r šnwty* and *imy-r prwy-ḥd*, while it is not uncommon for a vizier to hold all of them. The titulary of the vizier is also full of high 'honorific' titles such as *iry p't*, *ḥ3ty-* and so on; these titles are never found in the titularies of non-viziers in anything like the same concentration.

Having removed the vizierial holders of each title from the primary discussions, we can concentrate on those individuals who spent their period of tenure of these titles in only one or two administrative departments, a consequence of which will be that titles and title-patterns peculiar to these departments should be more easily visible. The viziers will not be ignored, but the overall consideration of the titles they held will be restricted to the chapter dealing specifically with the office of the vizier.

The Selection of Titles in the Titulary of an Official

An Old Kingdom official may hold titles of a number of different levels of importance, and it is imperative to make some remarks on how the titularies that we see today, principally in tombs, may have been composed. There are two main theories that one can attempt to document: that the titles given in a tomb represent 'the accumulation of a lifetime' (Baer, *Rank and Title*, 35), or that they represent those held by the individual at the time the tomb was to be decorated.

The material used to examine these ideas consists of the titles of those officials whose biographies give some unambiguous indications of promotions they received, and others whose tombs appear to have been decorated at two different phases of their careers. These are:

a. Biographies

<i>pth-špss</i>	
<i>k3i-gmni</i>	(151)
<i>sšm-nfr</i>	
<i>izi</i>	(Edfu)
Name Lost	(173)
<i>nhbw</i>	(90)
<i>ibi</i>	(Deir el Gebrawi)

b. Others

<i>ḥ'f-ḥwfw I</i>	(104)
<i>sš3t-ḥtp</i>	(126)
<i>k3i</i>	(136)
<i>sšm-nfr III</i>	(131)
<i>r'-špss</i>	(95)
<i>pth-ḥtp II</i>	(50)
<i>nfr-sšm-ptḥ</i>	(87)

This material is regrettably very restricted, and this problem should be considered when evaluating the following conclusions. In addition, as it all comes from a funerary context, it may give us some idea of title-holding as represented on tomb walls, but there is no way of relating this to the reality of the administration, given the less than historically accurate nature of many tomb inscriptions.

The following promotions are evident for the officials in group a:

- ptḥ-špss:** Urk. I, 52
 Weserkaf - [wr ḥrp ḥmwt]
 Sahure - ḥry-sšt3 n k3t nbt
- k3i-gmni:** Edel, MIO 1 (1953), Taf. II
 Djedkare - (lost)
 Wenis - z3b 'd-mr
- sšm-nfr** cf. Kanawati, Excavations at Saqqara I, 9
 Djedkare - z3b zš
 Wenis - z3b shd zš
 Teti - z3b 'd-mr, ḥry-tp nzwt
- izi:** Edel, ZAS 79 (1954), 13
 Djedkare - smsw ḥ3yt nt ///
 Wenis - ḥq3 ḥwt
 Teti - 1. mdḥ zš nzwt, z3b 'd-mr, ḥry-tp nzwt
 2. [ḥ3ty-', smr w'ty], ḥry-tp '3 n sp3t
- Name Lost** Urk. I, 216.11-217.1
 shd n qd
 imy-r qd
 mdḥ qd nzwt
 smr w'ty, mdḥ qd nzwt m prwy
 imy-r k3t
- nḥbw:** Urk. I, 216.1-4
 qd
 shd n qd, mty n z3
 ḥry-tp nzwt, mdḥ qd nzwt
 smr w'ty, mdḥ qd nzwt m prwy
- ibi:** Davies, Deir el-Gebrawi I, pl. XXIII
 Merenre - ḥ3ty-', smr w'ty, ḥry-tp '3 i3tft
 [Pepy II] - imy-r šm'w

Due to its unpublished condition, we cannot say any more about the other titles held by sšm-nfr. For the rest, where one of the titles in these biographies appears elsewhere in the tomb of that official, it seems always to be one of that man's highest titles. Some lesser titles are either ignored or were no longer held when the main sequences of titles were inscribed - for example, z3b 'd-mr in the biography of k3i-gmni and smsw ḥ3yt nt /// in that of

izi, although z3b 'd-mr does reappear in the other parts of the latter's tomb. Thus the biographies suggest that the principal title strings represented only those held by the owner at the time the tomb was decorated.

Listings of the different titles of the officials in group b will be found in the Prosopography; note that the material for one phase of the careers of pth-htp II and r'-šps is very slight. In the case of sš3t-htp the titles imy-r k3t nbt nzwt, wr md šm'w and wty inpw appear in both titularies; there are numerous overlaps in both titularies of k3i, but very few in those of h'f-hwfw I and nfr-sšm-ptb. The titles of sšm-nfr III are particularly interesting in that, unlike k3i, his earlier title of imy-r zš 'nzwt did not appear in his vizierial titulary, which is somewhat surprising in view of the incidence of this title among other viziers (see below page 314). Did sšm-nfr not list this title again as it appeared on an adjacent wall? Against this we note that the titles imy-r prwy-'h3w and hry-sš3 n wdt-mdw nbt nt nzwt are repeated.

The above evidence tends to suggest that lower-ranking titles found in the non-biographical inscriptions of a tomb need not necessarily have been held at a period before the official's promotion to the higher offices enumerated therein. From this one is forced to conclude that an official could hold a number of different positions in one administrative area simultaneously: for example, an imy-r šnwt may also have been hry-tp šnwt and zš šnwt at the same time. It is surely unlikely that an official could have exercised all these functions, and it seems quite probable that these titles were received in successive promotions; however he clearly wished to retain these titles, at least for use in his tomb inscriptions; perhaps they also served as a mark of his authority and level of competence in the administration.

In the following pages it may be stated or implied that a certain title was held before promotion to a higher office. As we have seen, such statements should be considered only as suggestions, which, although plausible, cannot be directly proved from the evidence presently at our disposal.

Terminology and Other Notes

The terms 'memphite' and 'provincial' will be used in relation to the place of burial of an official, 'memphite' covering the necropolises containing the tombs of men who in all probability were based in the capital city, the principal of which were Giza, Abusir, Saqqara and Dahshur, and lesser ones Abu Roash, Heliopolis and Meydum. 'Provincial' covers all other sites, the vast majority of which are to be found in the area between the Faiyum and Aswan.

The expression 'relevant officials' is adopted here to refer to men who have an entry in the Prosopography by virtue of holding one or more of the titles being studied; these titles can additionally be referred to as 'relevant titles'.

In the discussion of the titularies, the titles are split up into a number of groups as follows: legal titles, scribal titles, titles associated with the organisation of labour, granary titles,

treasury titles, honorific titles, titles of 'king's son', other high administrative titles, religious titles, royal institution titles, and other titles. Each appears only where there is something significant to be said. The first five groups each approximate to the area of administration covered by the principal titles *imy-r hwt wrt* (6), *imy-r zš 'nzwt*, *imy-r k3t (nbt) (nt) (nzwt)*, *imy-šnwt(y)*, and *imy-r pr(wy)-hd*, and the types of titles covered by each term will be summarised in the relevant chapter. Honorific titles are those which are more a representation of a man's status (or rank) and relationship with the king than an indicator of a specific office, although they may have originally embodied a particular function. *iry p't*, *h3ty-*, and *smr w'ty* are good examples of what is meant. 'Royal institution' refers to something, most frequently associated with a royal cult, set up by the king or for his benefit, examples of which are pyramids and sun temples. Other priestly titles are classed as religious titles, and 'other titles' concerns titles which do not fit easily into any other group but are worthy of discussion.

The related but different forms of the title forming the subject of each chapter, for example *imy-r pr-hd* vis-à-vis *imy-r pr-hd n hnw*, are discussed after the principal ones. These 'variant forms' will be considered as separate titles in their own right unless the evidence suggests them to be mere graphic variations on the principal title.

It should be noted that the order of officials in the lists at the beginning of each chapter is only approximate, and it must not be assumed that the writer believes that official X preceded official Y, but rather that the two of them were alive and held office in a similar period of the Old Kingdom.

3 The Overseers of the Great Mansions

General

Of the group of important administrative titles forming the subject of this study, those of **imy-r hwt wrt** and **imy-r hwt wrt 6** have been selected as representing the area of legal activity, **hwt wrt** (literally perhaps 'great mansion') being conventionally translated as 'court' or similar.¹

Table 7 gives the known holders of these titles buried in the memphite necropolises in the Old Kingdom or early First Intermediate Period. One example not included in this list is part of a block found in the vicinity of the tombs of **q3r** and **idw** at Giza, the title being **imy-r hwt wrt 6 m3'**;² this is the only occurrence of the element **m3'** with this title. As the title is not attested for either **q3r** or **idw**, the identity of the owner of the block is uncertain, and may duplicate another occurrence in this list.

The earliest holder of either title appears to be **k3i** (136), probably of the reign of Neweserre. There are three or four further holders of **imy-r hwt wrt 6** and seven of **imy-r hwt wrt** in the fifth dynasty and twelve or thirteen **imy-r hwt wrt 6** and twelve **imy-r hwt wrt** in the sixth and after, the latest of which is **ttw** (160) (First Intermediate Period).

There is only one possible holder of **imy-r hwt wrt 6** buried outside the memphite region, **ny-'nh-ppy km** of Meir. He dates to the middle sixth dynasty, and the title is here written



³ No parallel for this would seem to exist, as

the writing suggests a unique title **imy-r pr-wr 6** rather than **imy-r hwt wrt 6**. It thus appears probable that neither of the two titles currently under consideration are found outside the capital.

1 **Wb.** III, 4.

2 Simpson, **Giza Mastabas II**, 31, fig. 42.

3 Blackman, **Meir V**, pl. XII; date, Baer, **Rank and Title**, 84 (212)

Table 7

List of holders of *imy-r hwt wrt* and *imy-r hwt wrt 6*1. *imy-r hwt wrt*

Mid fifth dynasty		* 'nh-m'-hr; zzi	(30)
		nfr-sšm-ptḥ	(87)
* k3i	(136)	zṯw	(115a)
'nh-m'-k3i	(31)	* mḥw	(69)
ntr-wsr	(91)		
		Middle sixth dynasty	
Djedkare ?		k3i-pw-inpw	(142)
h'-mrr-ptḥ	(106)	r'-ḥwf	(94)
šhm-'nh-ptḥ	(124)	iḥy	(14)
		idw	(23)
Late fifth dynasty		Later sixth dynasty	
sšm-nfr; ḥb3	(132)	hkni-hnmw	(99)
3ḥt-ḥtp	(4)	ḥnty-k3w-hr	(110)
* ptḥ-ḥtp; tfi	(50)	* wr-k3w-b3; ikw	(40)
Teti-early Pepy I			
* nfr-sšm-r'; šši	(88)		

2. *imy-r hwt wrt 6*

Mid fifth dynasty		* mrrw-k3i; mri	(68)
		* mḥw	(69)
* k3i	(136)		
		Middle Pepy I-middle Pepy II	
Djedkare		* ptḥ-ḥtp	(51)
* ptḥ-ḥtp dšr	(47)	* mry-tti	(63)
* ptḥ-ḥtp	(48)	* mrrr	(67)
* sndm-ib; inti	(120)	* nfr-sšm-sš3t; ḥnw	(89)
Late fifth-early sixth dynasty		Later Pepy II	
* hnmw-nti	(113)	* nb-k3w-hr; idw	(82)
* k3i-gmni; mmi	(151)	* h'-b3w-hnmw; biw	(102)
Middle Teti-middle Pepy I		End Old Kingdom or later	
* nfr-sšm-r'; šši	(88)	mri; idw	(57)
		* tṯw	(160)

* indicates vizier at some point in his career

The writings of both titles are quite regular, and show no obvious development during the Old Kingdom that might render them useful for palaeographic study. At all periods writings of the group **ḥwt wrt** with or without the final **t** and/or the house determinative are common. The the writing of the figure six is most frequently $\equiv \equiv$, but occasional forms $\begin{array}{c} | | \\ | | \end{array}$ are found.

The differentiation of **imy-r ḥwt wrt** and **imy-r ḥwt wrt 6**

All holders of **imy-r ḥwt wrt 6** were viziers and may consequently be set aside and dealt with more fully in the study of the vizierate below. The one exception to this rule is **mri; idw** (57), and as such is immediately suspect. The late date of this example may explain the title **imy-r ḥwt wrt 6** as a corruption of **imy-r ḥwt wrt**.¹ He will thus to all intents and purposes be considered as a **imy-r ḥwt wrt**, but his titularial will only be compared with those of the more obvious **imy-r ḥwt wrt** after this title has been discussed (page 186).

The Titularies of the **imy-r ḥwt wrt**

There are three holders of **imy-r ḥwt wrt** whose careers may be divided into two parts: **k3i** (136), **pth-ḥtp II** (50) and **nfr-sšm-ptḥ** (87). In each case **imy-r ḥwt wrt** is only found in the earlier parts of their careers, which selection of titles only will be used in the following discussion. Other vizierial holders will be ignored for the present.

1. Legal Titles

As Helck has noted, the titles **mdw rhyt**, **iwn knmwt**, **nst ḥntt** and **ḥm-ntr m3't** are very much of a legal character.² The meaning of the first three is not clear, although the first two may be connected with legal matters for groups of the population indicated by the terms **rhyt** and **knmwt**. For the associations of **nst ḥntt** with other legal titles see further below pages 180-1. The presence of **z3b** in **z3b 'd-mr** suggests links with legal administration.³ The association of the goddess Maat with the concepts of order and justice explain the frequent appearance of the title **ḥm-ntr m3't**, and this title is doubtless in the period under consideration more of a secular and administrative than religious title. The titles connected with the **wsḥt**, 'broad hall', are also of a legal nature.⁴ Others with a similar function are obviously those connected with the **ḥwt wrt**. **wr md šm'w** also falls into this group, but this title

1 cf. Helck, *Beamtentitel*, 73 n. 45.

2 *op. cit.*, 74.

3 *id.*, *ib.*, 82.

4 *id.*, *ib.*, 72-3.

can also be associated with the organisation of workforces.¹ There are also titles specifically mentioning judgement (wd'-mdw).

Table 8

Principal Titles of non-viziers who held imy-r hwt wrt

Official	1	2	3	4	5	6	7	8	9	10	11	12	13	14	15
<u>k3i</u> (136)	X	X	X	X	I	X	X			2	0	X	2	X	
<u>'nh-m'-k3i</u> (31)	X	X	X	X		X	X			1	0	X	1	X	X
<u>ntr-wsr</u> (91)	X	X	X	X	X	X	X	X		3	1	X	2	X	
<u>h'-mrr-ptḥ</u> (106)		X	X	X		X				0	2	X	2		
<u>shn-'nh-ptḥ</u> (124)	X	X	X	X	H	X	X			3	0	X	2	X	
<u>sšm-nfr; ḥb3</u> (132)	X		X	X	H	X	X	X		2	0	X	0	X	X
<u>3ḥt-ḥtp</u> (4)	X	X	X	X	H	X		X	X	4	0	X	0		X
<u>ptḥ-ḥtp</u> II (50)	X	X	X	X	H	X				1	2	X	0	X	X
<u>nfr-sšm-ptḥ</u> (87)		X	X			X	X			1	0	X	0	X	X
<u>zṯw</u> (115a)				X		X	X		X	1	0		0		X
<u>k3i-pw-inpw</u> (142)	X	X	X	X	H	X				0	0	X	0		
<u>r'-ḥwf</u> (94)										0	0	X	0		
<u>iḥy</u> (14)		X	X							0	1	X	0		
<u>idw</u> (23)	X	X	X						X	3	0	X	0		X
<u>ḥkni-ḥnmw</u> (99)		X	X			X	X			1	6	X	0		
<u>ḥnty-k3w-ḥr</u> (110)		X	X							0	2	X	0		
<u>mri; idw</u> (57)	X	X	X			X				1	0	X	0		

mri; idw is included for comparative purposes

Key to Columns:

- | | |
|--|------------------------------|
| 1 <u>hm-ntr m3't</u> | 2 <u>mdw rḥyt</u> |
| 3 <u>iwn knmwt</u> | 4 <u>nst ḥntt</u> |
| 5 H = <u>ḥrp wsḥt</u> , I = <u>imy-r wsḥt</u> , X = both | |
| 6 <u>z3b 'd-mr</u> | 7 <u>wr md šm'w</u> |
| 8 Titles with <u>hwt wrt</u> | 9 Titles with <u>wd'-mdw</u> |
| 10 Number of scribal titles | |
| 11 Number of labour-related titles | |
| 12 <u>hry-tp nzwt</u> | |
| 13 Number of other high administrative titles | |
| 14 Titles with <u>wd(t)-mdw</u> | 15 Royal Institution Titles |

1 For the first view, Helck, *op. cit.*, 19; for the second, Fischer, JNES 18 (1959), 265-6.

Table 8 shows these and other titles to be discussed in this chapter arranged in a presence-absence chart. From columns 1-9 it is clear that the titles of **mdw rhyt** and **iwn knmwt** are the most consistent indications of a legal official. It would seem that the number of legal titles in such an official's titularies decreased in the sixth dynasty, and some of them are no longer found after the reign of Pepy I or so, most noticeably **hrp wsht** and **nst hntt**.

hrp wsht appears in the early fifth dynasty (**ny-'nh-r'** (71) at Giza) and is held by several officials of that period. Its occurrences from the end of that dynasty are much less frequent, and it seems to disappear by the mid-sixth dynasty. There seem to be no holders buried outside the memphite region.

The same is true for the memphite **nst hntt**. There are no officials with this element in their titularies certainly later than the early sixth dynasty, but there are several whose date cannot easily be determined. The title is found in the provinces, but these holders all date to periods later than that already mentioned.¹ **nst hntt** may have served a different function in the provinces, as it was held there by men of overall higher rank than those at the capital - they are all nomarch or **imy-r šm'w** - and the title is always found immediately following **z3b 'd-mr**, as opposed to the variety of combinations which are found at Memphis.

The possibility has been raised by Junker that **nst hntt** does not have an independent existence as a title in the Old Kingdom.² Fischer notes that it is a separate title in the twenty-sixth dynasty, but suggests that it was not so earlier.³ Both writers connect it with **z3b 'd-mr** or **wr md šm'w** as an epithet 'of foremost place', reading **ny nst hntt**. An examination of the Old Kingdom material reveals that the situation is not so simple: of a total of fifty-five memphite examples, in twenty-nine the sequence **z3b 'd-mr, nst hntt** only is found, in ten **wr md šm'w, nst hntt** only, and the rest are either unclear or more complex. The complex examples include the following:

- | | | |
|-------------------------|--|----------------------------------|
| tp-m-'nh | - a) z3b 'd-mr, nst hntt. ⁴ | b) hry-tp nzwt, nst hntt. |
| 'nh-m-'-k3i (31) | - a) z3b 'd-mr, nst hntt. ⁵ | b) wr md šm'w, nst hntt. |
| ntr-wsr (91) | - a) z3b 'd-mr, nst hntt. | b) wr md šm'w, nst hntt. |
| | c) shd wr md šm'w, nst hntt. ⁶ | |

1 For example, **q3r** of Edfu (reign of Merenre, *Urk. I*, 253.6), and **hm-r'**; **izi** of Deir el Gebrawi (First Intermediate Period, Davies, *Deir el Gebrawi II*, pl. XVII).

2 Giza VII, 199-200.

3 Dendera, 99 n. 451.

4 Borchardt, *Ne-user-re'*, a) Abb. 101. b) p. 121 (bottom).

5 Mariette, *Mastabas*, a) 214, 216, 217, 218. b) 219.

6 Murray, *Saqqara Mastabas I*, a) pl. XX, XXIV. b) pl. XX, XXI. c) pl. XXIV

k3i-'pr - **shd n srw, nst hntt.**¹
st-k3i - **hrp wr md šm'w, nst hntt.**²
sšm-nfr; hb3 (132) - a) **iwn knmwt, nst hntt.** b) **z3b 'd-mr, nst hntt.**³

None of these examples is later than the end of the fifth dynasty. There are also no certain examples of the title appearing at the beginning of a string; consequently it may be argued that it is an epithet, in the fashion of **m3'** or **n mrwt**. In one example, it actually appears twice (with different titles in each case) in the same string:

z3b 'd-mr, nst hntt, iwn knmwt, shd wr md šm'w, nst hntt, imy-r hwt wrt.⁴

The fact of its repetition must surely indicate that it was regarded as an epithet. Although not restricted in use to the titles **z3b 'd-mr** and **wr md šm'w**, it is found only with titles that are frequently held by legal officials. It thus seems to be an epithet connected with legal administration found mainly with **z3b 'd-mr**, and probably became associated solely with this title from the early sixth dynasty onwards.

Only two examples of the title **imy-r wsht** are found in the titularies of holders of **imy-r hwt wrt**, and it does not seem to survive beyond the fifth dynasty. Every holder of this title was of high status (some were viziers at one time in their careers) and often had many titles. It may thus have been granted only to very special or important officials.

These officials held titles incorporating the expression **wd'-mdw** only from the end of the fifth dynasty. A survey of other holders of similar titles suggests that it was one of the more frequently found legal titles in the sixth dynasty, although it is first found in the early fourth dynasty (**ph-r-nfr** (46)) and again in the early fifth (**'nh-irs** (25) and **ny-'nh-r'** (71)).

In table 8, the titularly of **k3i-pw-inpw** has more affinities with officials of the early than the middle sixth dynasty, and it is suggested that he be dated a little earlier in the sixth dynasty than suggested in the Prosopography.

2. Scribal Titles

It is likely that any official who attained a high administrative position would have held titles connected with scribal administration, as a man of such importance must have acquired the ability to read and write. This might especially apply in a legal environment, assuming that verdicts, disputes and so on were recorded either for archives or the benefit of the parties involved.

1 Hassan, **Giza II**, fig. 185.

2 Junker, **Giza VII**, Abb. 85.

3 a), b) Mariette, **Mastabas**, 399.

4 Tomb of **ntr-wsr** - Murray, *op. cit.*, pl. XXIV.

Column 10 of table 8 shows that most of the **imy-r hwt wrt** held such titles. In many cases the title is also associated with a legal function. One such title is **z3b shd zš** (held by **3ht-htp**), as well as those concerned with petitioners (**iry sprw1 - k3i**, **ntr-wsr**, **pth-htp II**, **3ht-htp** and **nfr-sšm-ptb**), and those connected with the **hwt wrt** or **wsht - sšm-nfr**; **hb3** and **'nh-m-'-k3i**.

3. Titles associated with the Organisation of Labour

These only appear in any great number in the titulary of **hkni-hnmw**, and are in all probability unrelated to his tenure of **imy-r hwt wrt**. He seems to have had two distinct aspects to his career (legal and concerned with the organisation of labour), and the titles from each appear in two groups, with **wr md šm'w**, which can belong with either, linking them together.

4. Honorific Titles

Column 12 of table 8 shows that all holders of **imy-r hwt wrt**, with the exception of **z1w**, the data on whom is incomplete, bore the title **hry-tp nzwt**. Such a connection between this and the legal 'profession' has already been noted by Junker and Helck.² Examination of the titularies of the remaining memphite holders of **hry-tp nzwt** suggests this still to be true. The situation of the provincial holders of **hry-tp nzwt** is not so clear, as the average number of legal titles held by these individuals is lower than in the memphite region; also it appears to be held almost always in conjunction with **smr w'ty**.³ The occurrence of the title **hry-tp nzwt m hwt wrt** in the tomb of **'nh-ppy hry-ib**⁴ may, by its use of a qualifier, emphasise a less prominent association of **hry-tp nzwt** alone with titles of a legal nature, suggesting that this title may have lost many of its older associations. On examining the relationship between the title **smr w'ty** and **hry-tp nzwt** in the capital, one finds a strikingly analogous situation: first sporadically in the early sixth dynasty and then more frequently as the dynasty advanced, a man holding **hry-tp nzwt** was likely to be granted the rank of **smr w'ty**, a peak being reached in the reign of Pepy II and the very end of the Old Kingdom. This is almost exactly paralleled in the provinces, and it appears to be a deliberate development in the patterns of titularies. This may have been as much due to a drop in the ranking of **smr w'ty** between the fifth and sixth dynasties as anything else; this conclusion may be drawn from the change in the latter title's position in Baer's ranking charts.⁵

1 Following this reading against that suggested by Fischer, ZAS 105 (1978), 58-9.

2 Respectively, Giza VII, 200-1; Beamtentitel, 60.

3 Exceptions: iti of Zawiet el Mayitin (LD II, 110e-g), although this tomb is damaged, and mniw of Meir (Blackman, Meir V, pl. XLVII-XLVIII).

4 id., Meir IV, pl. XV.

5 Rank and Title, 231-9.

The function of **hry-tp nzwt** may thus have changed as the sixth dynasty advanced, from a ranking title generally associated with particular administrative functions to a more general one. The specific functions seem to have been primarily legal, although it is also found with scribes and builders.¹

That the non-vizierial holders of **imy-r hwt wrt** were not of the highest rank is clear from the rarity of **smr w'ty** and the non-appearance of **iry p't** or **h3ty-** in their titularies. There is a similar lack of honorific titles of low rank, the only example being **rh nzwt** in the titulary of **hkni-hnmw**. This title is overall far more common than **hry-tp nzwt** and was mostly held by men with far less significant titles. It is likely that this exceptional occurrence is connected with the military and related titles held by this man, as it will be seen below that it is not infrequently held by overseers of works (pages 224, 230). **hkni-hnmw** also held **hry-tp nzwt**, and it is evident from the strings of titles in his tomb that the titles concerned with the organisation of labour (including **rh nzwt**) appear in a group at the beginning and the legal ones at the end, clearly indicating two separate aspects to his career.

5. Other High Administrative Titles

Such titles appear in the titularies of the **imy-r hwt wrt** only in the fifth dynasty, and occurrences consist principally of **imy-r zš ' nzwt** and **imy-r k3t nbt (nt) nzwt**:

	1	2	3	4
k3i (136)	X	X		
'nh-m'-k3i (31)		K		
ntr-wsr (91)	X	X		
h'-mrr-ptḥ (106)	X	X		
shm-'nh-ptḥ (124)	X		X	

Key to Columns:

- 1 **imy-r zš ' nzwt**
- 2 X = **imy-r k3t nbt (nt) nzwt**, K = **imy-r k3t (nt) nzwt**
- 3 **imy-r šnwt** 4 **imy-r prwy-ḥd**

It would appear that there was some concentration of the offices of **imy-r k3t nbt (nt) nzwt**, **imy-r zš ' nzwt** and **imy-r hwt wrt** on the same man in the middle to late fifth dynasty, or alternatively that the same official could hold a certain limited number of offices. This practice was discontinued towards the end of the dynasty, at

1 cf. Helck, *loc. cit.*

least as far as the **imy-r hwt wrt** were concerned, who henceforth held only that one high office. The generally less elaborate nature of these officials' tombs in the sixth dynasty is suggestive of lower status in that period.

The almost complete lack of titles relating to the granaries or treasuries shows that the economic side of the administration was not usually connected with the areas responsible for legal, scribal and labour-organisation matters, at least as far as non-viziers were concerned.

Table 9

Principal Titles of holders of **hm-ntr hqt** and **ht h3**

	1	2	3	4	5	6	7	8	9	10
ph-r-nfr (46)	X	X				X	X	0		0
wp-m-nfrt ^a	X	X				X		0	X	0
ssm-nfr I (129)	X	X			X	X	X	0		1
'nh-wsr-k3f (27)	X	X	X		X	X	X	0		0
k3i (136)	X	X	X	X	X	X	X	1	X	0
Name Lost ^b	X	X	X		X		X	0		0
ph-n-wi-k3i (45)	X	X	X		X		X	2		0
'nh-m-'-k3i (31)	X		X	X	X	X	X	1		0
r'-šps (95)	X	X	X	X	X	X	X	1	X	1
ssm-nfr; hb3 (132)	X	X		X	X	X	X	1		1
k3i-'pr ^c	X				X		X	0		0
3ht-htp (4)	X		X	X	X		X	2		2
pth-htp II (50)	X	X	X	X	X		X	1		0
'nh-m-'-hr (30)	X		X	X			X	0	X	0

References to unnumbered officials:

a. Reisner, **Giza I**, pl. 17ab. Borchardt, **Nefer-ir-ke3-re'**, 68, Abb. 74c. cf. **PM 32**, 762

Key to Columns:

1 **hm-ntr hqt**2 **ht h3**3 **mdw rhyt**4 **iwn kmwt**5 **z3b 'd-mr**6 **wr md šm'w**7 **hry-tp nzwt**8 Number of legal/scribal titles, such as **hrp zš iry sprw**9 **mdh zš nzwt**

10 Number of other scribal titles

6. Religious Titles

hm-ntr hqt was held by k3i, 'nh-m'-k3i, sšm-nfr; hb3, 3ht-htp and pth-htp II. Helck notes that it is often found with the title ht

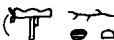
h3 (), but he would prefer to associate these two titles

with scribes, suggesting that hqt in particular was a protective deity for that profession.¹ There are three occurrences of the second title amongst the holders of imy-r hwt wrt: k3i, sšm-nfr; hb3 and pth-htp II, all of whom also held hm-ntr hqt. Table 9 shows the correlation of the two titles with each other and a number of further ones, and suggests that these two titles were probably more associated with legal than scribal titles for the period of their existence (both disappear at the beginning of the sixth dynasty). The most common scribal titles are those which also have legal associations (column 8); these aside, the high-ranking title mdh zš nzw is the most common (column 9). Two very consistent features are the frequency of their occurrences with z3b 'd-mr and hry-tp nzw, both of which titles strongly associated with legal titularies. It is perhaps likely that hm-ntr hqt and ht h3 had in themselves a type of honorific function as they were only granted to quite important officials and do not form part of a standard legal titulary. They may indeed have been guardian deities for this profession.

7. Titles connected with Royal Institutions

Examples of such titles held by the imy-r hwt wrt are listed below:

<u>'nh-m'-k3i</u> (31)	<u>hm-ntr r' m nhn-r'</u> <u>hm-ntr s3hw-r'</u>
<u>sšm-nfr</u> ; <u>hb3</u> (132)	<u>hm-ntr mn-swt-ny-wsr-r'</u> <u>hm-ntr ntr-swt-mn-k3w-hr</u> <u>hm-ntr nfr-dd-k3-r'</u> <u>zš n z3 nfr-dd-k3-r'</u>
<u>3ht-htp</u> (4)	<u>hm-ntr nfr-dd-k3-r'</u> <u>hm-ntr nfr-swt-wnis</u>
<u>pth-htp II</u> (50)	<u>imy-r niwt mn-swt-ny-wsr-r'</u> <u>shd w'b mn-swt-ny-wsr-r'</u> <u>imy-r niwt ntr-swt-mn-k3w-hr</u> <u>shd hm-ntr ntr-swt-mn-k3w-hr</u> <u>imy-r niwt nfr-dd-k3-r'</u> <u>shd hm-ntr nfr-dd-k3-r'</u>
<u>nfr-sšm-ptḥ</u> (87)	<u>hnty-š dd-swt-tti</u> <u>shd hm-ntr dd-swt-tti</u>
<u>zṯw</u> (115a)	<u>z3b imy-r zš dd-swt-tti</u>
<u>idw</u> (23)	<u>shd w'b 3ht-hwfw</u> <u>shd w'b wr-h'f-r'</u> <u>hnty-š mn-nfr-mry-r' ppy</u>

1 Beamtentitel, 47-8, 121.

These examples are nearly all of fifth dynasty date, and only four of the officials of that period in table 8 do not appear in this list. One feature common to these four (**k3i**, **ntr-wsr**, **h'-mrr-ptḥ** and **shḥm-'nh-ptḥ**) is that they each held two further very important administrative titles while the remainder held either one other (**'nh-m-'-k3i**) or none (the rest). It would seem that, as far as holders of this title are concerned, the less important an official the more likely he was to hold titles connected with these institutions. The bulk of such titles in the fifth dynasty is found with officials of lower rank than that of the whole group of men studied in this work; they are almost non-existent in the titularies of viziers until the later fifth dynasty, when a reform of the ranking of these titles seems to have been undertaken.¹ The granting of these newer types of title seems to have been more selective, perhaps confined to specially favoured officials. The only exceptions to this are the priesthoods of **idw** at the Giza pyramids, which simply show the maintenance of these older cults.

8. Other Titles

Titles with **wd(t)-mdw** are not infrequent, particularly **wd-mdw (m3')** **n hryw-wdb** (column 14 of table 8). Other examples suggest an association of this expression with legal administration.² As all but seven of the thirty-six Old Kingdom holders of titles with **wd(t)-mdw** are officials discussed in this work, in addition to having these legal associations, such titles were perhaps the mark of important officials, perhaps signifying their power to command that the business for which they were responsible be carried out.

The features of the titulary of **mri; idw** may now be compared with the characteristics noted above. Although he held the title **imy-r hwt wrt** 6, it will be seen from table 8 that his titulary is not dissimilar to that of legal officials of the sixth dynasty, and it would seem that the grouping of him with the other **imy-r hwt wrt** is correct.

The Viziers

1. **imy-r hwt wrt**

These are six in number: **k3i**, **pth-htp II**, **nfr-s3m-r'**, **'nh-m-'-hr**, **mḥw** and **wr-k3w-b3**. Since it is possible to separate their pre- and post-vizierial titularies, the first two examples have already been discussed. An attempt will now be made to discern whether or not the remainder were also **imy-r hwt wrt** before becoming vizier.

1 Baer, *Rank and Title*, 271.

2 **ny-m3't-sd** (Cairo, CG 133) was **wd-mdw n hwt wrt**, while **mrrw-k3i** (68) was **wd-mdw n srw**, presumably **srw** referring to those officials who were often responsible for judgement. See also Helck, *Beamtentitel*, 74, with n. 52.

Table 10

Certain titles of Viziers who held **imy-r hwt wrt**

	1	2	3	4	5	6	7	8	9	10	11	12	13	14	15
nfr-sšm-r' (88)		X	X							1	1	X	6	X	X
'nh-m'-hr (30)	X	X	X							1	0	X	4	X	X
mhw (69)		X	X			X				1	2	X	5	X	X
wr-k3w-b3 (40)															
k3i (136)	X	X	X		H					7	0	X	5	X	

The titulary of **k3i** as vizier is given for comparison

Key to Columns:

- | | |
|---|------------------------------|
| 1 hm-ntr m3't | 2 mdw rhyt |
| 3 iwn kmwt | 4 nst hntt |
| 5 X = imy-r and hrp wsht , H = only hrp wsht | |
| 6 z3b 'd-mr | 7 wr md šm'w |
| 8 Titles with hwt wrt | 9 Titles with wd'-mdw |
| 10 Number of scribal titles | |
| 11 Number of labour-related titles | |
| 12 hry-tp nzwt | |
| 13 Number of other high administrative titles | |
| 14 Titles with wd(t)-mdw | 15 Royal Institution Titles |

Table 10 shows some significant title patterns of these viziers, with the titulary of **k3i** from that part of his career added for comparison. This latter individual carried over several of his legal titles from his earlier career but not **imy-r hwt wrt**.¹ The titles of **nfr-sšm-r'** and **'nh-m'-hr** include several which are to be found in the first titulary of the almost contemporary **nfr-sšm-ptḥ** (87) and the slightly earlier **sšm-nfr; hb3** (132) and **3ḥt-ḥtp** (4), suggesting that they held the office of **imy-r hwt wrt** before their promotion to the vizierate. The three tombs in the 'Rue de tombeaux' at Saqqara may thus originally have been built for individuals who at some time held the office of **imy-r hwt wrt**, all of whom were later promoted to higher offices. **mhw**, of the reign of Pepy I, shows some legal titles not unlike those of **iḥy** and **idw**. He also may have held the office of **imy-r hwt wrt** before promotion. The titulary of **wr-k3w-b3** is very different, with no distinctive legal titles. Allowing for the possibility that much of it has been lost, it suggests that titularies at the end of the Old Kingdom

1 It is impossible to ascertain the vizierial titulary of **ptḥ-ḥtp** II.

were much different to what had gone before, and even that *imy-r hwt wrt* could have been written for *imy-r hwt wrt 6* (cf. *mri*; *idw* above), the holders of which office bore fewer legal titles (see next section).

It would appear that the tenure of the title *imy-r hwt wrt* was essentially a feature of a man's career before he was promoted to the vizierate. Only in the case of 'nh-m-'-hr is this title found in the immediate vicinity of *t3yty z3b t3ty*;¹ nowhere do *imy-r hwt wrt* and *imy-r hwt wrt 6* appear together. Thus the evidence for the association of *imy-r hwt wrt* with the vizierate is not strong - in the cases of *k3i*, *nfr-s3m-r'* and *mhw* it was presumably replaced by *imy-r hwt wrt 6*.

2. *imy-r hwt wrt 6*

Since this title appears to be the prerogative of the vizier at least until the end of the Old Kingdom, a fuller treatment of the titularies of its holders will be found below in chapter 8. The only matter to be resolved here is the extent to which the holders of this title had legal careers judged in the terms of reference established for the holders of *imy-r hwt wrt*. It is evident that the number of legal titles in the titulary of a vizier bore but little relationship to tenure of the office of *imy-r hwt wrt 6*. For example, *3ht-htp*; *hmi* (3) held many legal titles but never occupied that position, while there are several *imy-r hwt wrt 6* in the sixth dynasty without any other legal titles: *k3i-gmni*, *mry-tti*, *mrri*, *nb-k3w-hr*, *h'-b3w-hnmw* and *ttw*, while several others held only one legal title. We may say that tenure of *imy-r hwt wrt 6* bore no clear relationship to other legal titles in the manner of *imy-r hwt wrt*.

The Functions and Organisation of the *hwt wrt*

A. The relationship of *imy-r hwt wrt* to *imy-r hwt wrt 6*

As with many of the major institutions of the Old Kingdom, the only study devoted to the *hwt wrt* (6) is by Pirenne.² He saw the establishment of the *hwt wrt 6*, presided over by the vizier, as the major change in the juridical administration of the Old Kingdom. Each of the six courts was in the charge of a *z3b iry nhn*, and *hwt wrt* alone referred to the nome courts, which he saw as central to provincial administration. Helck has noted that *imy-r hwt wrt 6* is held by viziers,³ and suggests that this title shows the uppermost level of control of the *hwt wrt*. He assumes that the six courts were situated in the residence, and that each individual court was

1 Firth-Gunn, *Teti Pyramid Cemeteries* II, pl. 6A; I do not have a record of the positions of *imy-r hwt wrt* in the tomb of *mhw*.

2 *Institutions et Droit* I, 274-7, II, 114-20, III, 78-80.

3 An observation first made by Sethe, *ZAS* 28 (1890), 44.

controlled by an **imy-r hwt wrt**.¹

The logical conclusion from these latter remarks is that there should have been six men holding **imy-r hwt wrt** simultaneously from the middle of the fifth dynasty to the end of the Old Kingdom. If one presupposes that a man might hold such an office for thirty years (probably too high an estimate), then each position would be expected to change hands at least seven times in the whole period, making a minimum of forty-two **imy-r hwt wrt** desirable. In fact there are twenty-one currently known; more may well be awaiting discovery, but this is unlikely to raise this figure by a significant amount. From this number it seems most probable that there was only one of these officials holding the office at one time, giving an average tenure of office of approximately fifteen years per man. The total numbers of holders of **imy-r hwt wrt** 6 is sixteen, which is sufficiently similar to the total of **imy-r hwt wrt** for there to have been one holder of each title at the same time (these figures assume that **mry; idw** (57) was effectively **imy-r hwt wrt**).

The view of Pirenne that the **z3b iry nhn** were in control of the individual elements of the **hwt wrt** 6 derives from the biography of **wni**. The latter 'heard alone, together with the vizier, all secret matters conducted in the king's name for the royal harim and the **hwt wrt** 6'.² Including this man there were at least seventeen **z3b iry nhn** in the Old Kingdom,³ one **z3b iry nhn m3'**,⁴ and one **z3b iry nhn n hwt wrt**.⁵ This total is not unlike that of the **imy-r hwt wrt** and the **imy-r hwt wrt** 6, and although it may be a simple coincidence, the holders of **z3b iry nhn** could have acted alongside the **imy-r hwt wrt** or the vizier, one at a time. It is in fact the latter that is suggested by the biography of **wni**: this text does not associate this office particularly with the **hwt wrt** but stresses rather the connection with the vizier.⁶ Further evidence from the same text lends support to this interpretation: **wni** is said to have acted as the sole judge at the trial of the unnamed queen of Pepy I, assisted only by a **z3b iry nhn**, without the vizier or any other official being present.⁷ Here **wni** was surely acting as the vizier would have done and consequently the presence of the unnamed **z3b iry nhn** is explained by the association of that office with the vizier.

This conclusion is strengthened by the existence of the title **z3b iry nhn n hwt wrt**. Here a specific connection with the **hwt wrt** is noted, and the singularity of this title suggests that such an

1 **Beamtentitel**, 73.

2 **Urk.** I, 99.5-6.

3 Some examples, **ny-m3't-sd** (Mariette, **Mastabas**, 329), **sh̄m-k3i** (Murray, **Saqqara Mastabas** I, pl. VII), **sn̄dm-ib** (Cairo, CG 57007), **ny-k3w-r'** (Cairo, CG 1416), **inti** (Martin, **Hetepka**, pl. 34 (100-1)).

4 **hwi**, Fischer, **MMJ** 9 (1974), fig. 7.

5 **sh̄m-k3i**, Murray, *loc. cit.*

6 cf. Helck, **Beamtentitel**, 74 n. 50.

7 **Urk.** I, 100-1.



association was not normal for that office.¹

From the evidence of their titularies, it seems that the **imy-r hwt wrt** were almost always holders of several further legal titles, while the **imy-r hwt wrt 6** were not. For the most part, the **imy-r hwt wrt** held few or no other high administrative titles while the **imy-r hwt wrt 6** did. It is thus not inconceivable that that many of those viziers who held the special title **imy-r hwt wrt 6** did so by virtue of being the senior administrative official who had the overall supervision of the courts in his charge,² while the ordinary day-to-day running of the institution was carried out by the **imy-r hwt wrt**.

On this basis, one might expect all the other titles incorporating **hwt wrt** to refer to it in numbers less than six. As will be seen later in table 11, the majority of titles do in fact refer to the **hwt wrt** in the singular, but there are a few instances of **hwt wrt 6**. Four of the examples of the latter date from the reign of Pepy II and later, at which time it is possible that the terms **hwt wrt** and **hwt wrt 6** were interchangeable (page 188), and the meaning of these titles could be a little ambiguous. The rarity of subordinate titles at the **hwt wrt 6** suggests that the positions cannot have been particularly regular and may in fact have been special appointments for favoured individuals, associating them with an office otherwise reserved only for viziers.

One may only speculate on the reasons for the number six. Presumably the central legal establishment (wherever it was) was at some time composed of six courts, and by actually specifying the total number supreme overall control was intended, thus separating the holder of such a title from the next man in the chain of command, even though the number of courts for which the **imy-r hwt wrt** and the **imy-r hwt wrt 6** were responsible may well have been the same.

B. Other Aspects

The exact location of these 'great courts' is unknown. In no instance of either title of overseer is their place specified. However, two officials held titles which give locations to individual **hwt wrt** 's: the earlier is **hry-sšt3 n nzwt m hwt wrt nt pr nzwt**,³ and the later **z3b shd zš n hwt wrt** ( ) **imy-wrt nt hnw**.⁴ The first title seems to be the earliest certain

-
- 1 de Cenival has observed that the other elements in the titularies of **z3b iry nhn** suggest that they may have been involved in administrative as well as judicial work (RdE 27 (1975), 68-9).
 - 2 This is perhaps implied by a passage in the biography of **k3i-gmni**, where he says that he saw to all the matters dealt with in the **hwt wrt 6** for the king (see further below page 192).
 - 3 **3ht-htp**, Mariette, **Mastabas**, 70
 - 4 **wr-hnw**, LD II, 43b.

mention of the institution, and antedates further examples by several years.¹ No other institutions are known in the place termed **imy-wrt nt hnw**, but further references may be found to administrative titles or institutions compounded with **imy-wrt**.² Both of these Old Kingdom titles are unique, and such uniqueness may suggest that they refer to special positions. This lack of precision in most Old Kingdom titles impedes one's understanding of the workings of the **hwt wrt** or any section of the administration. Even the infrequent examples of the **hwt wrt** (6) mentioned outside titles (see below) do not give any indication of their location. Since little is known of the whereabouts of administrative departments in the Old Kingdom, Helck's suggestion of the residence can be only a guess. It is not impossible that the locations of these institutions were split in several places, some of them being in the residence (**hnw**; perhaps two were on the right side (**imy-wrt**) and two on the left ?), and possibly one in the **pr-nzwt**.

Pirenne would locate the **hwt wrt** (as opposed to the **hwt wrt** 6) away from the residence. He sees the former as nome-courts, based on the older view of the **z3b 'd-mr** as a provincial administrator.³ None of the holders of **imy-r hwt wrt** would now however be associated with provincial administration. The complete lack of instances of the **hwt wrt** in titles of provincial administrators would also argue against this view. Only one certain occurrence of this term is found outside the memphite region, in the Abydos decree of Neferirkare (see below), but this, concerned as it is with temple exemption, would surely be dealt with at the highest (memphite) level, particularly in the earlier parts of the Old Kingdom when provincial administration was not very highly developed.

The following restricted amount of material derives from contemporary sources (other than titles) and tells us a little about what took place in the **hwt wrt** (6) in the Old Kingdom:

- 1 The **hwt wrt** is mentioned in the Abydos Decree of Neferirkare, in which temple lands and servants are exempted from various duties:-

ir rmt nb n sp3t it.ty.fy hmw-ntr nbw ntyw hr 3ht-ntr
w'b.ty.sn hr.s m sp3t tw mrt ntt hr 3ht-ntr r-' idrw hn'
k3t nbt nt sp3t m3'.k sw r hwt wrt dy [ds.f r k3t] m m3t
sk3 it bdt ////.⁴

- 1 Although the term **hwt wrt** seems to appear in an inscription of the third dynasty vizier **mn-k3**, Lauer, *Pyramide à Degrés V*, pl. I
- 2 Another is also in the tomb of **wr-hww**, **imy-r gs imy-wrt '3 hr**; one is in a sixth dynasty letter to the vizier, **sht imy-wrt** (Grdseloff, *ASAE* 48 (1948), 510-11); there is also an example in the eighteenth dynasty - **z3b n imy-wrt** in the titulary of the vizier **imn-m-ipt** (Urk. IV, 1440 (D)).
- 3 *Institutions et Droit* II, 118-20.
- 4 Goedicke, *Königl. Dokumente*, Abb. 2.

As for any man of the nome who shall take a) any priest who is on the god's land and who does priestly service in return for it in this nome, or b) the **mrt** who are on the god's land, for estate-work and also any work of the nome,¹ you shall send him to the **hwt wrt**. He shall be sent to the granite (quarries) and his harvest (?) shall be given to...?? .²

- 2 A letter among the Abusir Papyri, almost certainly dating to the reign of Djedkare, refers to officials who were stationed at the door of the **hwt wrt**: - in **hr.ti** (?) **n m-' srw n rwt hwt wrt** - 'Have I not come back because of the officials at the gate of the **hwt wrt** ?'.³
- 3 In the biography of **k3i-m-tnt** (146), the ' matters of the secrets in the **hwt wrt** 's' are mentioned:- **///w hr mdw n št3 m hwt wrt**.⁴
- 4 In the first section of the biography of **3ht-htp; hmi** (3), officials of the **hwt wrt** are addressed by the deceased, but the text of the address has been lost. However, the second section gives us an idea of what could happen to an individual through the actions of the **hwt wrt**: **ir rmt nb hr.s n hr.s hwiw.sn hr.s m hwt wrt** - 'As for any man ... who is imprisoned or beaten on account of it in the **hwt wrt**...'.⁵
- 5 The responsibility of **k3i-gmni** (151) for carrying out the desires of the king in the **hwt wrt** 6 appears in his biography:-

sk wd.n hm.f ht nbt mrrt hm.f irt m hwt wrt 6; ir ht nbt wdt n hm.f irt m hwt wrt 6 r m3' hpr n m-'i r m3'.⁶

Lo, his majesty ordered all that he desired to be done in the **hwt wrt** 6; regarding all the things which his majesty ordered to be done in the **hwt wrt** 6 in truth, they happened truly through my action.

- 6 The function of the vizier and the **z3b iry nhn** is mentioned in the biography of **wni** (see discussion above page 189).

The references to the **hwt wrt** 6 (numbers 5 and 6) are in very general terms, and as such substantiate the idea that the number six was used to refer to all the happenings in the law-courts. It

- 1 For these terms, Goedicke, *op. cit.*, 26-7 (5).
- 2 For this restoration, *id.*, *ib.*, 31-2 (23-4).
- 3 **HPBM**, pl. LXXXA (3); Posener-Krieger, **ArchAb** II, 453, 458-60, 464-5.
- 4 **Urk.** I, 183.10; Schott, **Fs Otto**, 450.
- 5 Inscription A: Hassan, **Saqara** I, pl. XXVII B, fig. 18; Inscription B: *id.*, *ib.*, pl. XXVIII C, fig. 17
- 6 As reconstructed by Edel, **MIO** 1 (1953), Taf. II, columns 4-7.

is clear from the Abydos decree that the/a **hwt wrt** dealt with disputes arising from infringements to the exemptions granted to temples by the crown. The letter from Abusir (the place of writing, writer and addressee of which are unknown) refers to a method of dispensing judgement well-known from Egypt and which appears in all periods.¹ The biography of **k3i-m-tnt** contains the only reference to these institutions explicitly in the plural; the fact that it does not employ the term **hwt wrt** 6 further suggests that this was only used in special contexts, such as titles and when referring to functions of the vizier. Inscription B of the biography of **3ht-htp; hmi** is the only evidence for the punishments meted out by the **hwt wrt**.²

Sparse though this material is, it shows clearly that the **hwt wrt** were part of the legal system; it reinforces the conclusion that the individual **hwt wrt** 's were where actual judgement took place, and that the figure six was added in special cases to stress overall authority.

More evidence is forthcoming concerning legal organisation from later periods, and some of it may be of use in matters concerning the functions and location of the **hwt wrt** (6). Helck's suggestion that the **hwt wrt** were in the residence may derive in part from a

Middle Kingdom title  found on a stela of

ddw-sbk.³ The exact nature of these **hwt wrt** is not specified; the major objection to believing them to be the **hwt wrt** 6 is that **ddw-sbk** does not appear to have been a vizier while all true **imy-r hwt wrt** 6 seem to have held this office.⁴ Allowing for this problem it is still possible (by analogy) that these institutions existed in Memphis in the Old Kingdom.

On a fragment from the tomb of **dhwtj-nht** at El Bersheh (no. 1)

 , presumably **imyw-r hwt wrt**, are shown among people pulling a shrine.⁵ With them are men of **p**, **dp**, **wnw**, Lower Egyptian

1 See Posener-Kriéger, *op. cit.*, 459-60 (p), 464-5.

2 There is one further reference possibly of Old Kingdom date to the **hwt wrt**, the context of which is unclear. Part of a false door from the Teti Pyramid Cemetery bears the text **/// hr.s gri m hwt wrt ipi** (el-Fikey, *The Tomb of the Vizier Re'-wer at*

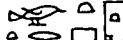
Saqqara, pl.16 (5)). **hwt wrt** is here written  , an

unusual writing for the Old Kingdom, and so it may be of First Intermediate Period date.

3 British Museum 255 - *BM Stelae IV*, pl. 36, cf. Helck, *Verwaltung*, 73 and *Beamtentitel*, 73.

4 For a convenient, if not exhaustive, set of examples, see Weil, *Veziere*, Indices, 54 (Middle Kingdom), 123 (New Kingdom) and 162 (Late Period).

5 Newberry, *El Bersheh II*, pl. IX (8).

Nomes 4/5 as well as the **mrt nzwt** and the **msw nzwt**. Little else seems to be known about the **hwt wrt** in the Middle Kingdom, but the association of these men with such ceremonies as this suggests that there could well have been a ceremonial role for the **imy-r hwt wrt** in the Old Kingdom.

A late Middle Kingdom or Second Intermediate Period text shows the **imy-r hwt wrt 6** (the vizier **imn-m-h3t**) acting in judgement regarding the possession of a slave-girl, and enforcing his judgement when it was queried.¹

From the New Kingdom there are no such references to the **hwt wrt** except in titles, but more is known about the structure of legal organisation, at least from the standpoint of the vizier. The principal source of this is the three parallel texts known as the 'Duties of the Vizier' found in Theban private tombs.² It is clear that the vizier was regarded as the highest judicial authority in the land (or at least in the part of the land under his control), who was required to act in certain types of dispute, and perhaps function as a 'court of appeal' in other cases. Legal affairs seem to have held an important position among the concerns of the vizier at this time. The inscriptions always speak of the vizier holding

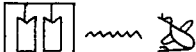
court in the 'Hall of the Vizier' (), and the **hwt**

wrt never in fact receives a mention, yet the owners of the tombs in which these texts are found were all **imy-r hwt wrt 6**. Consequently, either the function of the **hwt wrt 6** is not covered in these texts, or else they did not represent an actual institution at that time but rather refer back to an ancient one that had survived in a title only held by the senior legal official of the land. Old Kingdom evidence suggests that the **hwt wrt (6)** were very much real institutions in that period, but it is probable that they were replaced by a newer systems at a later date, with the title **imy-r hwt wrt 6** remaining as part of the titulary of a vizier.

Since there is no representational evidence for the **hwt wrt** in the Old Kingdom, we now turn to the range of activities shown by titles associated with it (table 11). Numbers 1-6 in this table are scribal in character, 7-17 connected with judgement, and 18-24 administrative and/or judicial. It is notable that the scribal titles are in the minority, although one might expect there to have been many such officials to keep the records. Perhaps the scribes who worked in the **hwt wrt** were not necessarily attached to that

1 Smither, *JEA* 34 (1948), 31-4.
 2 In the tombs of **wsr** (no. 61; *PM* 1², 246), **imn-m-ipt** (no. 29; *PM* 1², 46), and **rh-mi-r'** (no. 100; *PM* 1², 206). A convenient edition may be found in *Urk.* IV, 1103-17. These texts are translated by Davies (*Rekh-mi-re'* II, 88-94) and Helck (*Verwaltung*, 29-43 with comments). Helck considered this text to be a Middle Kingdom composition (*op. cit.*, 2), but it has been argued recently that it is an early eighteenth dynasty work, alluding to earlier periods (van den Boorn, *Or* 51 (1982), 369-81).

Table 11

Titles incorporating the element *ḥwt wrt* (6)

Title	Number of Holders
1 <i>šḥd zš n ḥwt wrt</i>	2
2 <i>imy-r zš ḥwt wrt</i>	1
3 <i>ḥrp zš n ḥwt wrt</i>	2
4 <i>zš smsw n ḥwt wrt</i>	1
5 <i>imy-r zš 'prw n ḥwt wrt</i>	1
6 <i>zšb šḥd zš n ḥwt wrt imy-wrt nt ḥrw</i>	1
7 <i>ḥry-sšt3 n wd'-mdw (nb) n/m ḥwt wrt</i>	4
8 <i>ḥry-sšt3 n wd'-mdw (nb) n/m ḥwt wrt 6</i>	3
9 <i>ḥry-sšt3 n wd'-mdw št3 (nb) n ḥwt wrt</i>	3
10 <i>ḥry-sšt3 n scmt w' m ḥwt wrt 6</i>	1
11 <i>wd'-mdw m ḥwt wrt</i>	2
12 <i>wd'-mdw m ḥwt wrt 6</i>	1
13 <i>wd'-mdw št3 n ḥwt wrt</i>	2
14 <i>sm3' wd'-mdw n ḥwt wrt</i>	3
15 <i>wd-mdw n ḥwt wrt</i>	1
16 <i>zšb iry nḥn n ḥwt wrt</i>	1
17 <i>šḥd nḥt-ḥrw n ḥwt wrt</i>	1
18 <i>ḥry-sšt3 n mdw št3 n ḥwt wrt</i>	1
19 <i>ḥry-sšt3 n mdw št3 n ḥwt wrt 6</i>	1
20 <i>ḥry-sšt3 n ḥwt wrt</i>	8
21 <i>wr md ḥwt wrt</i>	1
22 <i>ḥry-sšt3 n md3t n ḥwt wrt</i>	1
23 <i>ḥry-sšt3 nzwt m ḥwt wrt nt pr-nzwt</i>	1
24 <i>ḥry-tp mdw n wd'-mdw št3 n ḥwt wrt</i>	1
25 <i>ḥry-tp mdw št3 n ḥwt wrt</i>	1

References:

- wr-ḥww* - LD II, 43b
inpw-m-ḥ3t - Quibell, *Excav. Saqq.* (1905-06), pl. XV
- pth-ḥtp; iy-ni* - Hassan, *Saqqara II*, pl. LXXXVII (B)
- sšm-nfr; ḥb3* (132) - Mariette, *Mastabas*, 399
pth-ḥtp; iy-n-'nh - Hassan, *op. cit.*, fig. 34b
- pth-ḥtp; iy-n-'nh* - as 3
- sbky* - Daressy, *ASAE* 16 (1916), 198-204
- wr-ḥww* - LD II, 43b
- 3ḥt-mḥw* - Giza tomb G2375, unpublished
pth-ḥtp - Junker, *Giza VII*, Abb. 89
b3-šps - Curto, *Gli scavi italiani a el-Ghiza*, fig. 16b
3ḥt-ḥtp (4) - Petrie-Murray, *Memphite Tomb Chapels*, pl. IV
- mrrw-k3i* (68) - Duell, *Mereruka II*, pl. 212
ny-'nh-snfrw - de Morgan, *Dahchour II*, fig. 27
sbky - as 5

continued

Table 11 continued



- 9 **mḥw** - Smith, *BMFA* 56 (1958), 56-7, fig. 1
r'-wr II - Junker, Giza III, Abb. 46
pth-ḥtp - *id.*, Giza VII, Abb. 89
- 10 **pth-špss; imy** - Fischer, *MIO* 7 (1960), 304 n.9
- 11 **k3i-'pr** - Hassan, Giza II, fig. 185
3ḥt-mḥw - as 7
- 12 **iḥy** - Maspero, *MMAF* II, 202
- 13 **st-k3i; si** - Junker, *op. cit.*, Abb. 86; **3ḥt-mḥw** - as 7
- 14 **ḥrw** - *BM Stelae* I², pl. IX (1)
k3i-'pr - Hassan, Giza VI³, fig. 150
'nh-m-tnt - Fischer, *op. cit.*, fig. 3
- 15 **ny-m3't-sd** - Cairo, *CG* 133
- 16 **šḥm-k3i** - Murray, *Saqqara Mastabas* I, pl. VII
- 17 Name unknown - Fischer, *Offerings*, 80 n. 26
- 18 **ntr-wsr** (91) - *id.*, *ib.*, pl. XX
- 19 **r'-špss** (95) - *LD* II, 64b
- 20 **k3i-m-nfrr** - Cairo, *CG* 65
ny-m3't-sd - Mariette, *op. cit.*, 329
ḥtp-ḥr-3ḥt - *id.*, *ib.*, 341; **pth-špss** - *id.*, *ib.*, 323
iti-sn - Hassan, Giza V, fig. 122
ny-sw-qd - Mariette, *op. cit.*, 403
wr-dd-ptḥ - Firth-Gunn, *Teti Pyramid Cemeteries* II, pl. 62
pth-ḥtp - Junker, *op. cit.*, Abb. 89
- 21 **[s]ndm-ib** - Hassan, *op. cit.*, 276
- 22 **pth-m3'-ḥrw** - Quibell, *Excav. Saqq.* (1907-08), 26 (916)
- 23 **3ḥt-ḥtp** - Mariette, *op. cit.*, 70
- 24-5 **3ḥt-mḥw** - as 7

institution, or else only certain favoured individuals were permitted to use the term **ḥwt wrt** in titles. In addition, titles termed legal/scrival ones (such as **z3b imy-r zš** and **ḥrp zš iry sprw**) may have fulfilled these functions. Scribal titles were present in the titularies of most **imy-r ḥwt wrt**, and so the institution was in many cases probably not specified. Many additional officials may have been of insufficient status or means to possess an elaborate tomb.

Far more references are made to the **ḥwt wrt** in titles connected with judgement (**wḏ'-mdw**) or the administration of the institution. This is hardly surprising as these functions were conceivably more specialist than scribal ones. The titles connected with judgement differentiate between judging everything (**wḏ'-mdw (nb)**) and judging secret matters (**wḏ'-mdw št3**). These may be not unrelated to the two categories of legal documents referred to in the eighteenth dynasty 'Duties of the Vizier' texts.¹ Titles employing **nḥt-ḥrw**

1 For example, *Urk.* IV, 1109.11-1110.8.

seem sometimes to have associations of judgement.¹

For the associations of the title **z3b iry nhn** with the **hwt wrt** see above page 189. The element **iry nhn**, written  or  ,

is found in the titularies of viziers in the Middle and New Kingdoms to such an extent that it must surely be a survival of a more ancient functional title, perhaps of a legal nature.²

The title **wr md hwt wrt** recalls the groups of ten men present in the 'Duties of the Vizier'.³ These latter groups are the **wr md sm'w**, which have a separate existence in the Old Kingdom, and were possibly concerned with work-organisation as well as legal matters.⁴ The title **wr md hwt wrt** is only held by one man who also holds the comparable (and similarly unique) title of **wr md hwt-nh**. These may be special titles referring to a more ordinary function such as **wr md sm'w** (not held by this man, **sndm-ib**) in the later Old Kingdom, and may be associated with legal administration. Thus in this respect the functions of the **hwt wrt** in the Old Kingdom may indeed parallel that of the Hall of the Vizier in the New Kingdom.

The principal lower administrative title in the **hwt wrt** would seem to be, to judge from the number of holders, **hry-sst3 n hwt wrt**. The eight holders of this office date between the middle of the fifth and the early sixth dynasty. Their titularies differ from those of the **imy-r hwt wrt** in some degree, and no holder of this office seems to have attained this latter title. Legal titles do not seem to be particularly prevalent among the holders of **hry-sst3 n hwt wrt** with the exception of **k3i-m-nfrt**; only the title **hm-ntr m3't** is held in nearly all cases. The most frequent honorific title they held is not **hry-tp nzwt** but rather **rh nzwt**, indicating lower rank. However, titles that may have some lower-ranking judicial connotations (**z3b imy-r/shd z3**, **z3b shd iry md3t**) are not infrequent, and indicate their association with the administrative functions of the **hwt wrt**.

It is tempting to see in the above title the immediate subordinate of the **imy-r hwt wrt**. It is unclear why the title should disappear after the early sixth dynasty, as there does not seem to be any obvious replacement for it among those discussed above. Perhaps there was an administrative reorganisation at that time, the main result of which was to reduce the number of titles extant in various institutions.⁵ It follows from this that the most

1 Fischer, *Offerings*, 73.

2 Examples, Weil, *Veziere*, Indices, 54 (Middle Kingdom) and 122 (New Kingdom). It is perhaps unlikely that it is connected

with the Old Kingdom title   , probably read **mnw nhn**.

3 *Urk.* IV, 1104.8; for an illustration, see Davies, *Rekh-mi-re'* II, pl. 25.

4 Fischer, *JNES* 18 (1959), 265-6.

5 This is reflected in the lower number of titles and tombs in this dynasty as opposed to the fifth; evidence will be

probable solution is that the functions of **hry-sšt3 n hwt wrt** were incorporated into those of another title, perhaps **imy-r hwt wrt**, which seems to have been the only regular administrative title associated with the **hwt wrt** in the sixth dynasty. The fact that there is no titulary of a holder of **imy-r hwt wrt** which contains **hry-sšt3 n hwt wrt** or indeed many titles incorporating **hwt wrt** makes it impractical to suggest any further ranking of offices within that institution.

Conclusions

From the middle of the fifth dynasty it would appear that in overall charge of the legal system was the vizier with the title **imy-r hwt wrt 6**. The courts (the overall number and location of which are uncertain) were controlled on a practical basis by an **imy-r hwt wrt**, who would be a legal official, to judge from the evidence of his earlier career. The exact division of the processes of judgement is unknown, but there were many men who had titles that associate them with the act of **wd'-mdw** in the **hwt wrt**, some of whom also held other functions in that institution. These men were again usually legal officials. It is to be presumed that they would assist the **imy-r hwt wrt**, with the **imy-r hwt wrt 6** as the hearer of special types of case or perhaps acting as a court of appeal.¹ The number of specified scribal functions in the **hwt wrt** is not great, but it is assumed from the scribal associations of many of its officials that it was often not specifically mentioned. There are some scribal/legal positions which may have involved duty in legal institutions. The evidence is insufficient for a ranking table of titles in the **hwt wrt** to be usefully established.

found in the following chapters for further reductions in the numbers of important title-holders in the sixth dynasty.

- 1 The statement in the 'Duties of the Vizier' that the vizier heard every case (**Urk. IV, 1114.12**) must be a generalisation about the theoretical nature of his duties rather than the practical. One may compare this to the situation of the king being the high priest of every cult - in practice, he can only have occasionally carried out the duties, delegating most of the everyday work to full-time priests.

4 The Overseers of the King's Documents

General

The title **imy-r zš ' nzwt** is usually considered the most important title in the scribal administration of the Old Kingdom. Helck sees it as a later equivalent of the older title **mdḥ zš nzwt**,¹ although this would seem a little simplified as it ignores the element ' **nzwt** (see page 215-16 below). Its importance may be judged from its frequent appearance in the titularies of viziers and other high officials.

A list follows of the known holders of this title in the Old Kingdom. There appear to be two variant forms, **imy-r zš ' nzwt n k3t nbt nt nzwt** and **imy-r zš ' nzwt n wdt-mdw nbt nt nzwt**, both held by **mrw-k3i** (65), who does not hold **imy-r zš ' nzwt** alone. The uniqueness of these examples probably justifies our treating the qualifying phrases as simple embellishments; we will see that labour-organisation and **wdt-mdw** are frequently associated with the functions of **imy-r zš ' nzwt**.

Although we have not included it in table 12, the title **imy-r zš md3t** held by **h'-b3w-hnmw** (104) may perhaps be an abbreviation for **imy-r zš ' nzwt**. This title is written inside a small compartment on a wall of his burial chamber,² and it will be argued below (page 234) that **imy-r k3t nbt** in the same location is in fact **imy-r k3t nbt nt nzwt** shortened for reasons of space; **imy-r zš md3t** could fall into the same category.

1 Beamtentitel, 75-6.

2 Jéquier, Pepy II III, pl. 52

Table 12

List of holders of *imy-r zš ' nzw*

A. Memphite:

Neferirkare

* *wšš-pth; izi* (37)

Neweserre/mid fifth dynasty

sšm-nfr II (130)* *sh̄m-'nh-pt̄h* (123)* *kš̄i* (136)*z̄tw* (115)

Menkauhor

* *ph̄-n-wi-kš̄i* (45)*ty* (157)*n̄tr-wsr* (91)

Early Djedkare

* *sšm-nfr* III (131)* *r'-šps* (95)* *pth-htp dšr* (47)

Mid-later Djedkare

* *pth-htp* (48)* *pth-htp I* (49)

Later fifth dynasty

h̄'-mrr-pt̄h (106)*kš̄i-pw-inpw* (141)*mš-nfr* (54)*sh̄m-'nh-pt̄h* (124)

Early Wenis

* *sndm-ib; inti* (120)* *šht-htp* (2)* *šht-htp; h̄mi* (3)*irw-kš-pt̄h* (13)* *sndm-ib; m̄hi* (121)

Later Wenis

* *iḥy* (15)* *iy-nf̄rt; šš̄nf* (6)

End fifth-early sixth dynasty

* *hnmw-nti* (113)* *kš̄i-gmni; mmi* (151)

Teti

* *nfr-sšm-r'; šš̄i* (88)* *'nh̄-m-'-hr; zzi* (30)* *mrrw-kš̄i; mri* (68)

Early Pepy I

* *h̄nty-kš̄i; iḥhi* (109)* *mhw* (69)* *pth-htp* (51)

Middle Pepy I-early Pepy II

* *mry-tti* (63)* *mrr̄i* (67)* *nfr-sšm-sš̄t; h̄nw* (89)* *idw I; nfr* (22)* *'nh̄-mry-r'* (33)

Middle Pepy II ?

hnmw; hnmw-nti (111)* *mry-r'-mry-'nh̄-pt̄h* (62)

Later Pepy II

* *ny-h̄b-sd-nfr-kš-r'* (72)* *tti* (156)

Table 12 continued

Late Pepy II-post Old Kingdom

* šm3i	Koptos ¹
* hnqꜣ; iy...f	Deir el Gebrawi ²

* indicates vizier at some time in their careers

Three titles which have been interpreted as *imy-r zš ' nzwt* are not so considered here; all antedate the earliest certain occurrences of the latter in the reign of Neferirkare. In the tomb of *k3i-m-nfrt* at Giza (GIIS), a damaged block bears the text  ,

restored by Junker to *imy-r zš ' nzwt*.³ It is also possible to restore *zš ' nzwt*, which title has the advantage of being attested in the fourth dynasty (*izi* (17) and *nfr* (84)), while *imy-r zš ' nzwt* is not.

The second occurrence is in the tomb of *mry*. (58) at Saqqara, where  is read by Helck as *imy-r zš ' nzwt*, but

corrected by Fischer to *imy-r zš md3t n 'w nzwt*.⁴ Although not an example of the title under consideration here, it may represent an earlier equivalent (see page 216 below).

The third example comes from the lower lintel of the southern false door of the tomb of *k3i-pw-nzwt; k3i* at Giza (G4651):⁵



As there is a substantial break beneath the *r*, it is unlikely that all the signs are to be read as one title *imy-r zš ' nzwt*. Since both *imy-r pr* and *zš ' nzwt* form part of the titulary of *k3i-pw-nzwt*,⁶ there can be little doubt that they should be restored here.

The title of *imy-r zš ' nzwt* first appears in the titulary of the vizier *w3š-ptḥ*, dated to the reign of Neferirkare. There are twenty-four further holders in the fifth dynasty but only seventeen in the sixth, and those principally before the second quarter of

1 Mentioned in royal decrees, *Urk. I*, 295-304; date, Kanawati, *op. cit.*, 112-4.
 2 Davies, *Deir el Gebrawi II*, pl. XXIII-XXXVI; date, Kanawati, *op. cit.*, 117.
 3 *Giza X*, 30, Abb. 13.
 4 Respectively, *Beamtentitel*, 75 and *Varia*, 29-30.
 5 Junker, *Giza III*, Abb. 16.
 6 *id., ib.*, Abb. 15, and Abb. 17.

the reign of Pepy II. After that time only two or three holders are known for the period of sixty years or more to the end of the dynasty. No memphite examples have yet come to light from the seventh and eighth dynasties or the First Intermediate Period.

There are nine holders of this title buried in the provinces, and all were viziers. It was apparently an important element of the titulary of the 'Southern Vizier', as only four holders of that office did not hold *imy-r zš ' nzwt*. At least five of these viziers holding *imy-r zš ' nzwt* belong to the period from the middle of the reign of Pepy II to the end of the eighth dynasty (*d'w* to *šm3i*), and one (*hnqw*) to the First Intermediate Period.

In the fifth dynasty this title was evidently sometimes read *imy-r zš n ' nzwt*, with a extra n not belonging to the writing of *nzwt*.¹ The position of the t of *nzwt* varies in the fifth dynasty but in the sixth is most frequently written after the sedge plant,

above the *zš* sign. The ' element is usually written , but occasionally appears without the bookroll, or with the bookroll written after the *zš* sign. In the latter case (that of *h'-mrr-pth* (106)), it is indeed not impossible that the title should be read *imy-r zš md3t n ' nzwt* as with *mry* (58) (see previous page), although the rarity of this title and the relative commonness of *imy-r zš ' nzwt* perhaps argue against this.

The Titularies of the Non-viziers

Only eleven of the memphite holders of this title did not attain the vizierate. In addition, we can study the titles of three men who certainly held *imy-r zš ' nzwt* before their promotion to vizier - *k3i*, *sšm-nfr* III, and *r'-špss*, making a total of fourteen.

1. Scribal Titles

This heading can describe any title incorporating the word *zš*, which should indicate the holder's involvement with scribal functions at some point in his career. Some such titles have legal as well as (or perhaps even in preference to) simply scribal functions, such as *hrp zš iry sprw* and *hrp zš wsht*. These and other major title groups are represented as a presence-absence chart in table 13.

The most obvious conclusion from columns 1-8 of this table is that the number of scribal titles was not necessarily high, which suggests that these men often pursued careers not solely involved with the processes of writing, since such a general scattering of scribal titles would probably come about from involvement with the bureaucratic aspects of any administrative department.

 1 On the question of this extra n, and a somewhat unlikely later interpretation, see Ward, *Or* 51 (1982), 382-9.

Table 13

Principal Titles of non-viziers who held **imy-r zš ' nzw**

	1	2	3	4	5	6	7	8	9	10	11	12	13	14	15
sšm-nfr II (130)				X		X			0	0	1		X		
k3i (136) *		X	X						7	0	2	X	X	X	
z_{tw} (115)			X						0	0	0			X	
ty (157)				X					0	1	1		X	X	X
mrw-k3i (65)									0	0	0		X		
ntr-wsr (91)	X	X							9	3	2	X	X		
sšm-nfr III (131) *									2	0	0		X		
r'-špss (95) *	X	X	X						10	0	2	X	X	X	
h'-mrr-pt_h (106)									4	2	2	X			
k3i-pw-inpw (141)	X	X						X	6	0	0	X	X		
m3-nfr (54)	X	X			X		X		8	0	0	X	X	X	
š_{hm}-nh-pt_h (124)	X				X				7	0	2	X	X	X	
irw-k3-pt_h (13)									1	0	0				
hnmw (111)									0	0	0			X	

* indicates vizier in later career

Key to Title columns:

- | | |
|---------------------------------|----------------------------|
| 1 hrp zš (nb) | 2 hrp zš iry sprw |
| 3 mdh zš nzw | 4 zš hryt-' nzw |
| 5 zš wr md šm'w | 6 zš ' nzw |
| 7 hrp zš pr hry-wdb | 8 hrp zš wsht |
| 9 Number of legal titles | 10 Number of Labour titles |
| 11 Number of other high offices | 12 hry-tp nzw |
| 13 Titles with wd(t)-mdw | 14 Religious titles |
| 15 Royal Institution titles | |

2. Legal Titles

The number of legal titles held by **imy-r zš ' nzw** (as established in chapter 3) is given in column 9 of table 13. **hrp zš iry sprw** is counted as a legal as well as scribal title. Of the seven officials with many legal titles (**k3i**, **ntr-wsr**, **r'-špss**, **h'-mrr-pt_h**, **k3i-pw-inpw**, **m3-nfr**, **š_{hm}-nh-pt_h**), four attained the rank of **imy-r hwt wrt**. In the fifth dynasty, it appears that it was not unusual for a man who a man who attained this latter office also to be promoted to **imy-r zš ' nzw**.

Of the remaining officials (**sšm-nfr** II, **z_{tw}**, **ty**, **mrw-k3i**, **sšm-nfr** III, **irw-k3-pt_h**, **hnmw**), information on the titularies of **mrw-k3i**, **irw-k3-pt_h** and **hnmw** is so restricted that valid conclusions cannot really be drawn. **sšm-nfr** II is a rare example of an **imy-r zš ' nzw** who seems to have held a series of scribal offices. **z_{tw}** held the title **mdh zš nzw** which was presumably an important scribal office (see further below page 215-16). The relationship

of **sšm-nfr** III to **sšm-nfr** II suggests that his titular be explained in the same manner as that of his father. **ty** 's high office may have come about as a result of very favoured status (see under honorifics below).

3. Titles connected with the Organisation of Labour

Column 10 of table 13 shows that such titles are very restricted. The officials so indicated, **ty**, **ntr-wsr** and **h'-mrr-ptb**, also held **imy-r k3t nbt nt nzwt**, which presumably accounts for the occurrences of these titles.

4. Honorific Titles

The most frequently found honorific title is **hry-tp nzwt** (column 12 in table 13), perhaps not surprising in view of the relationship described above between this rank and legal titles - all seven holders of **hry-tp nzwt** among the **imy-r zš ' nzwt** also held legal titles.

The title **smr w'ty** was held by **zrw**, **ty**, and **hnmw**. This rank is perhaps more significant as far as the two fifth dynasty examples are concerned, as most of even the moderately important officials buried around the pyramid of Pepy II (of which **hnmw** is one) held at least **smr w'ty** and not infrequently **h3ty-**, his other high honorific title. The presence of **smr w'ty** in the titular of **ty** must be related to the very special status he enjoyed, the most obvious indication of which is his very elaborate tomb. Tombs almost as exceptional as that of **ty** were also possessed by other men with titles not unlike those of **iri šn** which he mentions very frequently, such as **ny-'nh-hnmw** and **hnmw-htp** (manicurists) and **nfr** and **k3h3i** (singers),¹ but their titularies are shorter than that of **ty** and do not contain such a high honorific title as **smr w'ty**. Thus **ty** was a man exceptionally honoured, and as such may have attained his high civil administrative titles of **imy-r zš ' nzwt** and **imy-r k3t nbt nt nzwt** as a result of royal favour.

zrw attained even higher rank than **ty**, possessing additionally the titles of **h3ty-**, **sd3wty bity**, and **r p nb** among others. His especially high status should be attributed to his position as **z3 nzwt n ht.f**, and since such individuals in the middle fifth dynasty did not generally hold high civil office,² he may have acquired the title before his attainment of the highest position, assuming that he was not a true king's son.

The titularies of **sšm-nfr** II and III do not incorporate a single honorific title, which may have something to do with the fact that they fall into neither of the two classes so far discussed (favoured individuals with many honorific titles or legal officials holding **hry-tp nzwt**). It seems that **hry-tp nzwt** was granted principally to legal officials, as otherwise one might expect them to have held it.

1 Tombs, see PM 32, 639-44.

2 Schmitz, *Königsohn*, 167-8.

Other honorific titles are few in number and in all cases seem to be held by either ty or z_{tw} (or both). This is in accordance with the points about their titularies made above.

5. Other High administrative Titles

A detailed breakdown of the distribution of these titles will be found below.

	1	2	3	4
<u>sšm-nfr</u> II (130)		X		
<u>k3i</u> (136)	X	X		
<u>ty</u> (157)		X		
<u>ntr-wsr</u> (91)	X	X		
<u>r'-špss</u> (95)		X	X	
<u>h'-mrr-ptḥ</u> (106)	X	X		
<u>šm-'nh-ptḥ</u> (124)	X		X	

Key to columns:

- | | | | |
|---|----------------------|---|--------------------------------|
| 1 | <u>imy-r hwt wrt</u> | 2 | <u>imy-r k3t nbt (nt) nzwt</u> |
| 3 | <u>imy-r šnwt</u> | 4 | <u>imy-r prwy-ḥd</u> |

The appearance of this category of titles is a feature of the fifth dynasty only. The connection of imy-r zš ' nzwt with the title of imy-r hwt wrt has been mentioned above on page 204, and the careers of holders of these two titles were often quite similar.

The number of men who held imy-r k3t nbt (nt) nzwt as well as imy-r zš ' nzwt in the fifth dynasty is very notable, suggesting that some relationship must have existed between the control of royal documents and the execution of works.¹ The title imy-r zš ' nzwt m k3t nbt nt nzwt of mrw-k3i emphasises this association.

From the almost complete lack of high titles connected with the treasuries and granaries, and the total absence of subordinate ones, it is evident that connections between imy-r zš ' nzwt and these institutions were almost non-existent. In fact, both examples of such titles above are in connection with the granaries, and the officials (r'-špss and šm-'nh-ptḥ) each held two further important civil administrative offices. It is possible that, having proved their reliability and trustworthiness, they were appointed to the granary post as a recognition of their ability.

6. Religious Titles

Examples are found mainly in the titularies of ty, z_{tw} and hnmw. The former two officials probably gained them by the importance of

1 Fischer, *OMRO* 41 (1960), 6.

their positions; in the case of the latter, such titles seem to have been a standard element of a titular in the reign of Pepy II. As for the remainder, *hm-ntr hqt*, *ht h3* and *hm-ntr m3't* form the bulk of examples, and are usually associated with legal officials. The title *hm-ntr hr qm3-* is found in three instances (*k3i*, *ty*, *m3-nfr*). Helck divides the holders of this title into two groups, close royal acquaintances and legal officials, and notes the diversity of the two types of holder.¹ It is perhaps better to term Helck's second group scribal rather than legal officials, which classification best covers the examples he quotes and others. In addition to the seven examples enumerated by Helck, this title was held by *h'f-hwfw* I (104), *špsi*,² *b3-b3f* (42) and *k3i*. *h'f-hwfw* and *b3b3f* fall into Helck's first category, while the titular of *špsi* contains primarily titles of a scribal nature (*imy-r zš sp3t*, *imy-r zš 3ht tb-ntrt* (Lower Egyptian nome 12), *zš pr hryw-wdb*); that of *k3i* contains both legal and scribal titles. The titular of *špsi*, along with that of *sšm-nfr* I, reinforces the conclusion that *hm-ntr hr qm3-* is to be associated more with scribal than legal titularies. However, clarification of the classes of holders cannot further reveal the meaning of the title which, as Helck observes, is still unknown. It may be regarded both as another of the group of religious titles associated with favoured individuals and as one occasionally found in the titularies of important scribal officials.

7. Titles connected with Royal Institutions

ty held the title *shd hm-ntr r' m st-ib-r'*, and was also *imy-r* of four sun-temples and two pyramids. The latter group of titles are unique in the fifth dynasty, and suggest that, whether they had any practical function or not, these titles were created by the king for an especially favoured individual. The titular of a typical holder of *imy-r zš 'nzwt* includes no titles connected with royal institutions.

8. Other Titles

Ten of the fourteen men under discussion here held titles incorporating *wd(t)-mdw*, the commonest of which is *hry-sšt3 n wdt-mdw (nbt) nt nzwt* (9 examples), with *k3i*, *ntr-wsr* and *shm-'nh-ptb* additionally holding *wd-mdw n hryw-wdb*. Such titles appear more frequently than with the holders of *imy-r hwt wrt*, and suggests that *hry-sšt3 n wdt-mdw* was in some way associated with the responsibilities of *imy-r zš 'nzwt*. Assuming *imy-r zš 'nzwt* to be involved with record keeping, the function of *wd(t)-mdw* may have been not dissimilar, particularly if connected with the term *wd nzwt* used at the beginning of royal decrees. The link between these two functions is further emphasised by the title *imy-r zš 'nzwt n wdt-mdw nbt nt nzwt* of *mrw-k3i*.

1 *Beamtentitel*, 120 n. 3.

2 Cairo, JE 68923; unpublished, cf. *PM* 32, 443.

The Viziers

It is dangerous to speculate which viziers may have followed scribal careers and perhaps even held **imy-r zš 'nzwt** before promotion to the highest office. The titularies of **k3i** (136) and **r'-špss** (95) show that they held the office both before and after their promotion to vizier, but if the south wall of his tomb represents his full titulary as vizier, then **sšm-nfr** III (131) did not.

Such insight, however small, into the promotion of **imy-r zš 'nzwt** is not available for the sixth dynasty, since there is only one example of a holder of this office who was not a vizier, **hnmw; hnmw-nti** (111). From this rare occurrence we may even go so far as to speculate that, from the reign of Teti onwards, this office became the preserve of the vizier alone, and it is conceivable that men who were designated as future holders of that office were granted **imy-r zš 'nzwt**, but since their tombs were built during their tenure of the vizierate there is no way of substantiating this proposal. **hnmw; hnmw-nti** could have been an intended vizier who died before he was able to hold the office.

The titularies of the vizierial holders of **imy-r zš 'nzwt** do contain a few scribal and legal offices, although not to the same extent as their non-vizierial fellows. Viziers who never seem to have held the title **imy-r zš 'nzwt** have far less of these distinctive features in their titularies. There is insufficient evidence to point to viziers who might have held **imy-r zš 'nzwt** at an earlier stage in their careers with the exception of the well-known examples of **k3i**, **r'-špss** and **sšm-nfr** III.

The Department of the King's Document Scribes

A. The Organisation of **imy-r zš 'nzwt**

We have suggested that one holder of **imy-r hwt wrt** existed alongside one of **imy-r hwt wrt 6**, the former having control of the practical running of the **hwt wrt** (s) and the latter (the vizier) being in overall charge. Such a situation is also possible for **imy-r zš 'nzwt**, although there is no particular form of the title used only by viziers.

Such duality is a problem only in the fifth dynasty, as there is only one non-vizier with this title in the sixth dynasty. Thirteen non-viziers holding **imy-r zš 'nzwt** are known for the fifth dynasty, together with fifteen or sixteen viziers (the exact sequence of viziers at the change of dynasty is not clear). It would seem that the office appears in the titulary of a vizier (**w3š-ptḥ** (37)) before it is found with a non-vizier (**sšm-nfr** II (130) or **k3i** (136)). It is apparent that the number of each class of holder is very similar, suggesting that there were likely to have been two **imy-r zš 'nzwt** simultaneously, a vizier in overall charge and a non-vizier who would then attend to the detailed daily administration of this section of the bureaucracy. Most of this group of viziers held one or more other high administrative titles, and it is likely that in the fifth dynasty at least it was felt necessary to spread the workload by appointing a subordinate who bore the

same basic title, although no evidence exists in writing for this subordination.

Such a partition was not maintained after the later fifth dynasty. This development may be connected with the other administrative changes in the late fifth dynasty suggested by Baer.¹ It may also be due to changes in provincial administration. Although all the sixth dynasty holders (with one exception) were viziers, not all of them were buried in the memphite region. The nine provincial holders of both $\bar{t}3y\bar{t}y \bar{z}3b \bar{t}3\bar{t}y$ and $\bar{i}m\bar{y}-r \bar{z}\check{s} 'n\bar{z}w\bar{t}$ date from the end of the fifth dynasty onwards. The administration headed by the $\bar{i}m\bar{y}-r \bar{z}\check{s} 'n\bar{z}w\bar{t}$ must have handled all the relevant provincial as well as memphite matters in the fifth dynasty, as there is no evidence of any such titles outside the capital. By appointing a 'Southern Vizier', and also granting him the title of $\bar{i}m\bar{y}-r \bar{z}\check{s} 'n\bar{z}w\bar{t}$ a degree of devolution of administration may have been obtained, and thus one of the probable functions of the non-vizierial $\bar{i}m\bar{y}-r \bar{z}\check{s} 'n\bar{z}w\bar{t}$ disappeared.

Only limited discussion has been devoted previously to the exact functions of this title, partly because little evidence is forthcoming and partly because the connection with royal records and document scribes is self-evident for most authors.²

The title is not found in such associations as to assist with conclusions about its functions, only its importance. Outside strings of titles in tombs, it appears in royal letters and decrees (see further below page 214-15), and without any surviving text to explain its appearance in the Abusir Papyri ($\bar{i}r\bar{w}-k3-\bar{p}th$ (13)).³

It is likely that work connected with the $'n\bar{z}w\bar{t}$ took place in the $\bar{i}z(\bar{w}y) n \bar{p}r 'n\bar{z}w\bar{t}$ mentioned in various royal decrees.⁴ This would seem to be one of four related administrative departments in the Old Kingdom - the others are the $\bar{i}z n \bar{p}r \bar{h}r\bar{y}w-\bar{w}db$, $\bar{i}z n \bar{p}r \bar{m}d3\bar{t}$ and $\bar{i}z n \bar{h}r\bar{y} \bar{h}t\bar{m} \bar{m}d3\bar{t}$. All four are often mentioned together in royal decrees. Helck remarks that there is no example of an overseer for the $\bar{i}z(\bar{w}y) \bar{p}r 'n\bar{z}w\bar{t}$ in a vizier's titulary to show overall control of this department, as there is for the other three.⁵ He suggests that $\bar{i}m\bar{y}-r \bar{z}\check{s} 'n\bar{z}w\bar{t}$ fulfilled that function. If so, it would be by far the most frequent of the four such overseer's titles, the clearest occurrences of which are in fact not in the titularies of viziers: $k3i$ (136), before his vizierate, was $\bar{i}m\bar{y}-r \bar{i}z\bar{w}y \bar{n}w \bar{h}r\bar{y} \bar{h}t\bar{m} \bar{m}d3\bar{t} 'n\bar{z}w\bar{t}/ \bar{p}r \bar{m}d3\bar{t}/ \bar{p}r \bar{h}r\bar{y}w-\bar{w}db$, and also $\bar{i}m\bar{y}-r \bar{z}\check{s} 'n\bar{z}w\bar{t}$; similar titles were held by $\bar{m}3-\bar{n}f\bar{r}$ (54).

1 Rank and Title, 300-2.

2 Helck is principally concerned with the history of the title (*op. cit.*, 75-6); he translates it as 'Vorsteher der Königlich-Briefschreiber'. Pirenne translates it as 'directeur de la chancellerie' (*Institutions et Droit* II, 181, III, 94), associating it with royal archives without further comment.

3 This latter is also the only high title found in these papyri apart from the mentions of bodies of priests named after viziers (Posener-Kriéger, *ArchAb* II, 568-70, 590).

4 *Urk.* I, 281.8; 281.14; 284.15; 290.12.

5 *op. cit.*, 72.

There are no further examples of overseers of the **pr md3t**, one of the **izwy pr hryw-wdb** (**ph-n-wi-k3i** (45)), and six of the **izwy hry htm md3t** (**r'-šps** (95), **pth-htp dšr** (47), **pth-htp** (48), **pth-htp I** (49), **k3i-gmni** (151) and **nfr-sšm-r'** (88)). It will be noted that all these officials were also **imy-r zš 'nzw**.

It is possible that the title of **imy-r zš 'nzw** may have carried with it overall responsibility for these other three related departments, as it is the only important title connected with them which is found consistently from the middle of the fifth dynasty onwards. There are a few lesser titles associated with the departments of the **pr hryw-wdb**, **pr md3t** and **(pr) hry htm md3t**.¹ Again, these titles are not frequently and consistently found, and show a distinct bias towards the later sixth dynasty. It would be logical for all these departments concerned with documents to a great extent to be supervised by the same man. **k3i** and **m3-nfr** must have been highly favoured to have been the only non-viziers to hold all these four offices.

B. Other Aspects

No indication may be obtained of the location of any of the offices of the departments concerned with the **'nzw**. Presumably they were part of a complex of departments administered by the vizier, probably at Memphis.

Much has been written as to the nature of an **'**. It would appear to be a term with a wide variety of uses, but was basically an authorisation, whether in a secular or religious context, which would declare something as a legal right.² It is used in the expression **ir.f ' n dqr.f**, 'to bring suit';³ it can define the limits of an official's jurisdiction, **mhty ' m niwt sp3wt rsy ' m mn-nfr-ppy**;⁴ and can even possibly refer to functions of gods, **'ntrwy '3 m qbhw**, probably referring to Hu and Sia.⁵ An **'nzw** is presumably a more specific example of the same, emanating from the most important source in the land - the king and officials acting on his behalf.⁶

The group of men most relevant to the further study of **imy-r zš 'nzw** are the **zš 'nzw (pr-'3)** themselves, who would have presumably written and administered the documents, A related title is **zš**

-
- 1 Some examples: **imy-ht pr hry-wdb** (**dw3-n-r'**, Mariette, **Mastabas**, 455), **shd pr md3t** (**nfr-sšm-k3**, Reisner, **Giza I**, fig. 308), **imy-r hry htm md3t** (**hnmw-htp**, Fakhry, **Sept Tombeaux à l'est de la grande pyramide de Guizeh**, fig. 7).
 - 2 For example, Théodorides, **RIDA 3e Ser.** 20 (1973), 78, n. 83; Vandier, **ASAE 36** (1936), 37; Baer, **ZAS 93** (1966), 6-7; Gunn, **JEA 34** (1948), 28 (3).
 - 3 **Urk. I**, 13.4.
 - 4 **Urk. I**, 220.2-3.
 - 5 **Pyr.** 467c, cf. Baer, *loc. cit.*
 - 6 cf. Goedicke, **JARCE 3** (1964), 31-2, with references, in particular n. 4.

' *nzwt hft-hr* (*pr*-³), the *hft-hr* element presumably referring to the 'presence' of the king. These two titles are only found four times in the titularies of *imy-r zš 'nzwt*. One of these officials is buried in the provinces ('*nh-ppy hry-ib* of Meir); the memphite examples are *sšm-nfr* II (130), *šhm-'nh-ptḥ* (123) and *idw* I (22). Of these four only *sšm-nfr* II was not a vizier.

A brief comparison of *zš 'nzwt* and *zš 'nzwt hft-hr* is relevant here. Of approximately thirty memphite holders of *zš 'nzwt hft-hr* (*pr*-³) and forty-seven *zš 'nzwt* (*pr*-³), only seven held both titles.¹ The most common honorific title with *zš 'nzwt* (*pr*-³) is *rh nzwt* while with *zš 'nzwt hft-hr* it is *hry-tp nzwt*, *rh nzwt* being found only with the earliest example.²

Some of these differences may be explained by examination of the dating of the holders. *zš 'nzwt* (*pr*-³) appears in the middle of the fourth dynasty (*izi* (17) at Saqqara and *nfr* (84) at Giza), and continues through to the end of the Old Kingdom, but is most frequent in the fifth dynasty. *zš 'nzwt hft-hr* (*pr*-³) makes its appearance in the middle/late fifth dynasty but is principally a sixth dynasty title. *hry-tp nzwt* is far more common than *rh nzwt* with *zš 'nzwt* (*pr*-³) in the sixth dynasty, thus making this difference less marked.

More of the higher honorific titles (*smr w'ty*, *sd3wty bity* and the like), more religious titles (especially *hry-hb*) and fewer legal titles occur with *zš 'nzwt hft-hr* (*pr*-³) than with *zš 'nzwt* (*pr*-³) in the sixth dynasty. From this it might appear that the former was the higher-ranking title in the sixth dynasty at least. There is only one example (*r'-wr* I) where these two titles appear in a rankable context, and in this case *zš 'nzwt* is the higher.³ There is more indirect evidence that the reverse was true in the sixth dynasty: the titulary of *idw* II, who holds both titles, contains the sequence *hry-tp nzwt*, *zš 'nzwt hft-hr*, *šhd zš 'nzwt*, *imy-r pr 'š*.⁴ One might expect *šhd zš 'nzwt* to outrank *zš 'nzwt* although there is no explicit evidence;⁵ on this assumption, *zš 'nzwt hft-hr* may have outranked *zš 'nzwt* in the later sixth dynasty. The situation thus changes between the fifth and sixth dynasties, and may be as a result of the increasing importance of the former title.

The basic title of *zš 'nzwt* is sometimes found as part of more complex ones. These attest *zš 'nzwt* in institutions such as the

1 *r'-wr* I (Junker, Giza III, Abb. 42a); *ir-n-3ḥt* (Hassan, Giza VI³, fig. 9); *idw* (Simpson, Giza Mastabas II, fig. 40); *ny-sw-ptḥ* (Junker, Giza VIII, Abb. 88); *mtw* (Cairo, CG 1397); *mrw* (Daressy, ASAE 16 (1917), 195); *idw* II (Junker, op. cit., Abb. 42-3).

2 *r'-wr* I (id., Giza III, Abb. 42a).

3 Baer, Rank and Title, 164; *r'-wr* is fifth dynasty.

4 Junker, Giza VIII, Abb. 41, 43.

5 The only other holder of either *zš 'nzwt* or *zš 'nzwt hft-hr* and *šhd zš 'nzwt* does not have the two titles in a rankable context (*r'-ḥtp*: compare statues Cairo, CG 163 and 312).

granary,¹ treasury,² and royal establishments,³ as well as in connection with fields.⁴ Titles such **zš 'nzwt** and **shd zš 'nzwt** hint at the hierarchy of the department, but we are unable to say whether any holders of **imy-r zš 'nzwt**, apart from the four mentioned above, held the lower offices before promotion to the highest one.

The title **zš 'nzwt** occurs several times in contexts other than that of tomb-owners, mostly with children and dependents depicted in the tomb of their father or patron. The following are some of the more interesting ones:

- 1 Two men, called **nfrt** and **k3i-m-nfrt** are shown with the titles **zš 'nzwt** and **imy-r pr** in the tomb of **ty** (157). Both carry papyrus rolls.⁵
- 2 One of the Wadi Hammamat inscriptions of **nḥbw** (90) shows a **zš 'nzwt** named **ḥnw** among the members of the expedition.⁶
- 3 A **zš 'nzwt**, **z3b imy-r zš**, (name lost) is shown doing accounts before the deceased in the tomb of **'nḥ-ppy ḥry-ib** at Meir.⁷
- 4 The late Old Kingdom or First Intermediate Period stela of **irt** from Akhmim bears the text in **h3y.s zš 'nzwt ḥrwy ir nn zš**, 'it is her husband, the **zš 'nzwt ḥrwy** who made this inscription'.⁸
- 5 The **ḥq3 ḥwt**, **zš 'nzwt ḥft-ḥr**, **gfgf** is shown among prostrate defaulters in the tomb of **mrrw-k3i** (68).⁹

In none of these examples is it clear whether the official concerned is acting in his capacity as **zš 'nzwt (ḥft-ḥr)** or otherwise. The men in example 1 are probably acting more as **imy-r pr**, which officials are frequently shown with a papyrus roll, reading or presenting it to the deceased.¹⁰ If the official in no. 2 were performing duties associated with the **'nzwt** which were probably needed to authorise the expedition, one might expect to find others like him in other texts left by quarrying expeditions, but no such examples are forthcoming; however, neither is it common for an

- 1 Such as **zš 'nzwt šnwt (irw-k3-ptḥ)** (13) and **shd zš 'nzwt šnwt ('nḥ-m-'-r'** (28)).
- 2 **shd zš 'nzwt pr-ḥd** in the titulary of **iy-mry**, Junker, Giza X, Abb. 53.
- 3 Among the titles of **r'-špss** (Cairo, CG 55).
- 4 **[zš] 'nzwt 3ḥt: ḥwti** (Cairo, CG 64).
- 5 Epron-Wild, *Tombeau de Ti I*, pl. XXI, XXVII.
- 6 *Urk. I*, 94.8.
- 7 Blackman, *Meir IV*, pl. XV (middle).
- 8 Cairo, CG 1613; *Urk. I*, 119.17.
- 9 Duell, *Mereruka I*, pl. 37.
- 10 For example, von Bissing, *Die Mastaba des Gem-ni-kai I*, Taf. XII.

overseer of works to be shown leading such an expedition, and these two observations may be related (above page 206). The officials from Meir and Akhmim appear to be acting as ordinary scribes, while the last example is in a predicament in which **hq3 hwt** often seem to have found themselves,¹ and the appearance of **zš 'nzwt hft-hr** is thus nothing particularly to do with this scene. One is forced to conclude that the proper functions of the **zš 'nzwt** were not subject-matter for the decoration of tombs, as was also the case with the activities of the **hwt wrt**.

The title **zš 'nzwt** continued into the Middle Kingdom, but most references also fail to give any idea of their function.² A /// (an uncertain sign, perhaps an overseer or the like ?) **zš 'nzwt whmwnf** appears in a list of men in the Illahun Papyri, the context of which is unclear - perhaps he was in charge of such men who worked in the Pyramid-town of Senwosret II.³

Titles incorporating **'nzwt** alone give further information on the types of activity supervised by the **imy-r zš 'nzwt**. Various 'letter-carriers' or just 'those concerned with papyri' (**iry md3t**) of the **'nzwt** are attested,⁴ as are sealers and men who dealt with 'authorisations'.⁵ Other titles referring to crews or divisions of men who were associated in some unclear manner with this area of administration.⁶ The existence of **'nzwt** for weapons presumably adds the **pr-'h3w** to the departments attested as involved with these documents.⁷ There are several unclear titles, one of which is perhaps to be associated with land.⁸

The above material displays the wide range of responsibilities of the department in the charge of the **imy-r zš 'nzwt**, and the number and variety of other areas of the administration with which it was associated.

-
- 1 Such as James, *Khentika*, pl. IX, although note that another scribal title, **mdh zš nzwt**, appears in a similar scene (Duell, *Mereruka I*, pl. 37).
 - 2 Several references, Helck, *Verwaltung*, 277 n. 5, 6.
 - 3 Griffith, *Hieratic Papyri from Kahun and Gurob*, Text, 41 (47); Plates, pl. 14.47.
 - 4 Such as **nfri** (Cairo, CG 1653) and **mry-nzwt** (Fischer, *Offerings*, fig. 1, with comments on p. 73). Depictions of **iry md3t** with papyrus rolls are common, for example, Epron-Wild, *Tombeau de Ti I*, pl. XXVII.
 - 5 Respectively, **hnmw-htp** (Fakhry, *Sept tombeaux à l'est de la grande pyramide de Guizeh*, fig. 7), and **imi-st-k3i** (Junker, *Giza VI*, Abb. 82). For the term **hryw-**, 'authorisations', see Fischer, *ZAS* 105 (1978), 52-6.
 - 6 The titles **imy-r izwt nw 'nzwt** of **k3i** (136) (Mariette, *Mastabas*, 230) and **shd 'prw 'nzwt** of **k3i-'pr** (Epron-Wild, *op. cit.*, pl. XXI).
 - 7 **imy-r 'nzwt 'h3w** in the titularies of **ny-htp-ptḥ** (LD II, 72a) and **ny-s'nh-3ḥt** (73) (Hassan, *Giza III*, fig. 107).
 - 8 **iry hnbtt n 'nzwt n pr-'3**, Fakhry, *op. cit.*, 14, fig. 6.

Conclusions

In the fifth dynasty, there were probably two men holding the office of **imy-r zš 'nzw**t at the same time. One of these was a vizier, who would have had overall control of the associated departments, and the other a less important official who would have supervised the details of the administration. In the late fifth dynasty a change is evident whereby the title was henceforth held only by the vizier, although there is an isolated non-vizier in the reign of Pepy II. This is perhaps to be associated with an expansion of local provincial administration.

The principal department controlled by the **imy-r zš 'nzw**t was known as the **izwy** or **pr n 'nzw**t, for which no other important title is attested. It is possible that three other related departments, the **izwy/pr hry htm md3t**, **izwy/pr md3t** and **izwy/pr hryw-wdb** came under his control as well, as independent titles at an elevated level associated with these are only infrequently found.

The activities of the department concerned with **'nzw**t covered a wide range. Administrative functions are evident (sealing, general overseeing and care), as are relations with other administrative entities (the granary, treasury, armoury, fields, and the organisation of labour). Basically only one type of scribal function is attested, the obvious **zš 'nzw**t (**pr-'3**) and **zš 'nzw**t **hft-hr** (**pr-'3**), the former being the more common in the fifth and the latter in the sixth dynasty. Although a wide range of associations with the (**pr**) **'nzw**t are found, more officials than are currently known must have been associated therewith. It is likely that relations with this department were so basic and essential that a specific association was not given in many titles.

Such a range of relations with other departments is not unexpected, as it is probable that these royal documents were essential for all that was carried out in the king's name. Associations seem to have existed with all the major administrative offices with the exception of the legal system. One might not envisage royal commands as appropriate in that context, although we can imagine much time was spent on legal matters resulting from disputes provoked by the contents of some **'nzw**t.

imy-r zš 'nzwt seems to have been one of the most important of the group of high titles presently under discussion when held by the vizier. All these titles occur frequently in the titularies of such officials, but in cases where the vizier is addressed directly by the king (in letters or decrees), the frequency with which the title **t3yty z3b t3ty** is accompanied by **imy-r zš 'nzw**t is remarkable. Examination of such texts in **Urk. I** shows this in the following examples (page numbers in brackets): The letters of Djedkare to **r'-špss** (p. 179) and **sndm-ib; inti** (pp. 60, 62); the Koptos decree of Pepy II addressed to **d'w** (p. 280); and two Koptos decrees

of Neferkauhor to šm3i (pp. 296, 302).¹ The other decrees of Neferkauhor and those of Horus dmd-ib-t3wy to šm3i and idi respectively (pp. 300, 303, 304) do not quote this title.

There is only one occurrence of another high administrative title in all the above inscriptions, imy-r k3t nbt nt nzwt in the inscriptions of sndm-ib; inti (120). This is doubtless to be explained by that man's importance as a builder, for which compare the rest of his biography. Thus imy-r zš ' nzwt seems to be the administrative title quoted most frequently along with that of the vizierate in the above contexts; in the example of r'-špss (95) it is the only title. In contexts such as these where space was restricted, it would have been logical to include only the most significant titles, perhaps showing the importance of this section of the bureaucracy.

We have seen that the title of imy-r zš ' nzwt is only attested from the reign of Neferirkare. Since a scribal bureaucracy evidently existed in the preceding period, we will attempt to ascertain what titles, if any, it superseded.

Helck sees imy-r zš ' nzwt as replacing a more ancient title, mdh zš nzwt.² Of the relatively few scribal titles that appear before the reign of Neferirkare, this is by far the most frequent. Six holders of this title antedate k3i (136) and ztw (115) in the middle of the fifth dynasty: hzy-r',³ wp-m-nfrt,⁴ hm-iwnw (96), mry (58), dw3-n-r' (161) and ztw.⁵ Only two were viziers, and the total would scarcely seem to suffice for the period of time involved (some point in the third dynasty to the early fifth). mdh zš nzwt continued to be held after the mid-fifth dynasty, most frequently by viziers (r'-špss (95) (before vizierate), izi of Edfu,⁶ 'nh-m-'-hr (30), mry-r'-nfr; q3r of Edfu,⁷ mrrr (67), nfr-sšm-sš3t; hnw (89) and nn-gm⁸). Some change in the functions of the title is evident as it is no longer found in conjunction with the title mdh

, the reading of which is still not known, but would seem to have been a scribal title.⁹ The reason for this may have been the change of mdh zš nzwt from a functional title to one granted as a mark of favour to certain officials, most of whom held the title imy-r zš ' nzwt.

There is also evidence that the title may have undergone a more fundamental change. In the tomb of mrrw-k3i (68) two men by the

1 The beginning of the address of the Dahshur decree of Pepy I is another possibility (p. 209), although this has been interpreted differently (Helck, *op. cit.*, 140).

2 Beamtentitel, 75-6.

3 Cairo, CG 1428.

4 Reisner, Giza I, pl. 17a.

5 Simpson, Giza Mastabas IV, fig. 47.

6 Alliot, Rapport sur les Fouilles de Tell Edfou (1933), 22.

7 Urk. I, 253.6

8 Unpublished, cf. PM 32, 622.

9 Helck, *op. cit.*, 76-7.

names of **mrr**i and **wḥ**mi are shown prostrate before taxing officials, and are given the titles of **ḥq3 ḥwt** and **mdḥ zš nzw**t.¹ There is a vast difference in rank between these men and the other sixth dynasty holders of **mdḥ zš nzw**t. Unless these men held the title in respect of the estates of **mrrw-k3i** (and there is no way of telling that this is not the case), it may have been reduced to a very low rank in the sixth dynasty and thus formed part of an earlier stage in the careers of the high officials who held it.

It is quite possible that in the fourth dynasty the office of vizier incorporated important scribal functions without expressing it in the form of titles. In the third to early fifth dynasties, some combination of viziers and earlier holders of **mdḥ zš nzw**t may have fulfilled the duties which were later the responsibility of the **imy-r zš 'nzw**t.

The title **imy-r zš md3t n 'nzw**t found with that of **mdḥ zš nzw**t in the titulary of **mry** (58) may represent a first attempt to introduce a new title to head the scribal departments, but its isolation in time indicates that it did not become a continuously occupied position.

1 Duell, **Mereruka** I, pl. 37.

5 The Overseers of Works

General

With the exception of the vizierate, titles translated 'Overseer of Works' - those beginning **imy-r k3t** - are the only ones studied here attested consistently from the beginning of the fourth dynasty onwards. They were presumably successors to the title **imy irty k3t nbt nzwt** found in the third dynasty titulary of '3-3ht.¹

Table 14 gives the known holders of these titles. These fall into four principal groups - **imy-r k3t nbt (nt) nzwt**, **imy-r k3t (nt) nzwt**, **imy-r k3t nbt**, **imy-r k3t**. The extent to which these represent the same title has never been discussed.² Because of this difficulty, when no specific title beginning **imy-r k3t** is intended, the group as a whole will be referred to by the translation 'Overseer of Works'.

For the same reason, the different writings and history of this group of titles will be described below following discussion of these differing forms.

Only one overseer of works is knowingly omitted from table 14: this is the unnamed **imy-r k3t nbt nt nzwt** mentioned in the tomb of **dbhn**, who may have been one of the well-known officials named in this list.³

1 Smith, *AJA* 46 (1942), fig. 9 (E); cf. Helck, *ZAS* 79 (1954), 76.

2 Helck would seem to group them all together (*Beamtentitel*, 99 n. 56), while Schmitz regards these forms as separate titles (*Königssohn*, 150).

3 *Urk.* I, 21.10; the nameless overseer of works in Borchardt, *Ne-user-re*, Abb. 50 is probably **minw-nfr** (55).

Table 14

List of Overseers of Works

A. Memphite:

1. imy-r k3t nbt (nt) nzwt

Early fourth dynasty		hn-k3	(97)
		* pth-špss	(52)
* nfr-m3't	(86)	ntr-wsr	(91)
ph-r-nfr	(46)	iy	(5)
Khufu		Djedkare (first half)	
* 'nh-h3f	(34)		
* hm-iwnw	(96)	* r'-špss	(95)
		* sšm-nfr III	(131)
Khufu-Khafre		* pth-htp dšr	(47)
		Djedkare (second half)	
* Name Lost	(170)		
* h'f-minw	(103)		
ddf-hr	(168)	* pth-htp	(48)
		* pth-htp I	(49)
Menkaure-early fifth dynasty		h'-mrr-ptb	(106)
		hwfw-htp	(107)
mry-ib	(59)	k3i	(137)
3hi	(1)	k3i-m-tntt	(146)
* sš3t-htp; hti	(126)	* sndm-ib; inti	(120)
d3ty	(165)		
'nh-hwfw	(36)	Wenis (first half)	
ny-'nh-r'	(71)		
		'nh-izzi	(26)
Sahure-Neferirkare		* sndm-ib; mhi	(121)
		Wenis (second half)	
* b3-b3f	(42)		
'nh-irs	(25)		
pr-sn	(44)	* ihy	(15)
* w3š-ptb; izi	(37)	h3zi	(98)
Neweserre/mid fifth dynasty		End fifth-early sixth dynasty	
'nh-wsr-k3f	(27)	* hnmw-nti	(113)
sšm-nfr II	(130)	* k3i-gmni; mmi	(151)
* minw-nfr	(55)	* nfr-sšm-r'; šši	(88)
ny-k3i-'nh	(75)		
* k3i	(136)	Middle-later Teti	
* šhm-'nh-ptb	(123)		
sšmw	(127)	s3bw; ibbi	(116)
		* 'nh-m-'-hr; zzi	(30)
Menkauhor-Djedkare		* mrrw-k3i; mri	(68)
		ny-k3w-izzi	(76)
* ph-n-wi-k3i	(45)		
ty	(157)		

Table 14 continued

Teti-early Pepy I		* mrrr	(67)
* hnty-k3i; ihhi	(109)	* nfr-sšm-sš3t; hnw	(89)
'nh-mry-r'; ny-sw-ihy	(32)	* idw I; nfr	(22)
		* 'nh-mry-r'	(33)
Middle to Late Pepy I		Middle Pepy II	
* mry-tti	(63)	* s3bw-ptḥ; ibbi	(117)
nhbw	(90)	* mry-r'-mry-'nh-ptḥ	(62)
Pepy I to early Pepy II		End Old Kingdom or later	
ptḥ-špss; impy	(53a)	* ttw	(160)
2. imy-r k3t (nt) nzwt			
Early fifth dynasty		k3i-tp	(152)
k3i-'pr	(139)	'nh-m-'-k3i	(31)
sšm-nfr I	(129)	dw3-r'	(162)
		itti	(20)
Neferirkare-Neweserre		Later fifth-early sixth dynasty	
snnw-k3i; kki	(119)	itti; 'nh-irs	(21)
ddf-hnmw	(169)	ny-k3w-r'	(79)
d3ty	(166)	r'-wr III	(92)
d3ty	(164)	'nh-ir-ptḥ	(24)
h'f-hwfw	(105)		
ny-k3i-'nh	(75)	Late Old Kingdom	
Middle fifth dynasty		k3i-'h3f	(139a)
sšmw	(127)		
3. imy-r k3t nbt			
End fourth dynasty		Later Pepy I	
iwn-r'	(8)	q3r; mry-r'-nfr	(135)
Later fifth-early sixth dynasty		Middle-later Pepy II	
h'-mrr-ptḥ	(106)	* mry-r'-mry-'nh-ptḥ	(62)
hṭp-hr-n-ptḥ	(100)	* h'-b3w-hnmw; biw	(102)

Table 14 continued

4. **imy-r k3t**

Mid fifth dynasty		Middle Teti	
k3i-'pr	(138)	* 'nh-m-'-hr; zzi	(30)
bb-ib; sndm-ib	(43)		
		Middle-later Pepy I	
Later fifth dynasty		Name Lost	(173)
s'nh-n-ptḥ	(118)	nhbw	(90)
		mry-ptḥ-mry-r'	(60)

B. Provincial:

1. **imy-r k3t nbt nt nzwt**

Middle Pepy II

* **ppy-nḥt** Abydos¹

2. Other Forms

Mid Fifth Dynasty

k3i-hnt I Hemamiya:²
imy-r k3t
imy-r k3t m sp3wt ḥrywt-ib šm'w

k3i-hnt II Hemamiya:³
imy-r k3t
imy-r k3t m sp3wt ḥrywt-ib (šm'w)

End Old Kingdom or later

tmrry Naga ed Deir:⁴
imy-r k3t nbt nt nzwt irrt m t3-wr
imy-r k3t nbt wdt irrt m t3-wr

* indicates vizier at some point in their careers

1 Cairo, CG 1573; date, Baer, **Rank and Title**, 71 (135), Kanawati, **Governmental Reforms**, 89.
 2 Petrie-Mackay, **Bahrein and Hemamieh**, pl. XX-XXVIII; date, Baer, **op. cit.**, 148 (543a).
 3 Petrie-Mackay, **op. cit.**, pl. IX-XIX; date, Baer, **op. cit.**, 147-8 (543).
 4 Peck, **Some Decorated Tombs of the First Intermediate Period at**

Chapter 5 - The Overseers of Works

There are a number of men whose inscriptions exhibit two of these overseer of works titles (never more):¹

ny-k3i-'nh (75)	imy-r k3t nbt nt nzwt imy-r k3t nzwt
sšmw (127)	imy-r k3t nbt nt nzwt imy-r k3t nzwt
h'-mrr-ptḥ (106)	imy-r k3t nbt nt nzwt imy-r k3t nbt
'nh-m-'-ḥr; zzi (30)	imy-r k3t nbt nt nzwt imy-r k3t
nhbw (90)	imy-r k3t nbt nt nzwt imy-r k3t
impy (62)	imy-r k3t nbt nt nzwt imy-r k3t nbt

In every example, one of the two titles is **imy-r k3t nbt nt nzwt**, and in no case do both occur in the same sequence, which immediately raises the possibility that the shorter form may simply be a compression of the longer due to the dictates of space.

In the tomb of **ny-k3i-'nh**, there is only one occurrence of each writing. Both are similarly arranged, with the **nzwt** sign appearing before the **imy-r**. The layout of the architrave illustrated by Mariette, where **imy-r k3t nzwt** appears, is cramped,² whereas the lintel shown by Petrie and Murray is more spaciouly arranged.³ Both writings appear again on the false door of **sšmw**, **imy-r k3t nbt nt nzwt** to the left of centre, **imy-r k3t nzwt** to the right. Both forms of **h'-mrr-ptḥ** again appear on the false door, the shorter on the panel, above the head of the deceased, the longer on the right inner jamb. The panel writing is almost certainly abbreviated for reasons of space. **imy-r k3t** in the tomb of **'nh-m-'-ḥr; zzi** is again found in cramped circumstances (before the kilt of the deceased), suggesting an abbreviated writing. All the titles that appear on the serdab blocks of **nhbw** are short ones, and it is likely that this is again **imy-r k3t nbt nt nzwt** compressed for reasons of space. This is also the case in one of the same man's Hammamat inscriptions (no. 21), where, having given the title in full at the beginning, it is necessary to refer to him as the father of another member of the expedition, and the title appears this time as just **imy-r k3t**. Finally **imy-r k3t nbt** of **impy** is found with his depiction in the mortuary temple of Pepy II, and the previous argument may apply again.

Naga ed-Dêr, 40-91, with dating on 83-7.

- 1 This disregards the occurrence of **imy-r k3t nbt nt nzwt m t3 r dr.f** in the titulary of **'nh-m-'-ḥr; zzi** as an example of the title **imy-r k3t nbt nt nzwt** with a epithet (rather like **m3'** and similar).
- 2 **Mastabas**, 311; now BM 1275, but with damage to the group of signs in question, see, **BM Stelae I²**, pl. XXI.
- 3 **Memphite Tomb Chapels**, pl. III.

Doubtless the title of **imy-r k3t nbt (nt) nzwt** was one very prone to compression, as the numerous omissions of the element **nt** show, but it is yet to be decided whether any of these shorter titles represent independent ones.

The Titularies of the Non-viziers

As in previous chapters, titularies will be examined using those of men who were not viziers, beginning with the most common form, **imy-r k3t nbt (nt) nzwt**.

A. **imy-r k3t nbt (nt) nzwt**

The principal titles of these officials are arranged in table 15. We shall use the titularies of three men who later became viziers, **sš3t-ḥtp, k3i (136)** and **r'-špss**.

1. Titles concerned with the Organisation of Labour

Helck has established a group of titles related in some way to the work of the **imy-r k3t nbt (nt) nzwt**,¹ of which the following are the principal ones: **sd3wty ntr...**, **imy-r mš'** and other 'military' titles, titles with **qd**, titles with **ḥmwt**, boat titles, titles with **'prw** or **nfrw**, **smsw izt** and **imy-r gs-pr**. To this list may be added **wr md šm'w**, which Fischer has suggested represents the organisation of groups of ten men,² as well as having legal associations - hence its position at the end of the labour titles and before the legal ones in table 15. There are also further titles incorporating the word **k3t**.

On these criteria, the following officials clearly spent much of their careers in this area of the administration: **mry-ib, sš3t-ḥtp, d3ty (165)**, **'nh-wsr-k3f, sšmw, iy, k3i-m-tnt, 'nh-izzi, 'nh-mry-r'** and **nhbw**. With the exception of **sšmw**, these men held high titles in none of the other administrative departments under consideration; although **sšmw** held the title of **imy-r šnwty**, the remainder of his titulary makes no reference to other positions that he may have held in the administration of the granaries.

Possible career patterns have already been suggested in the previous chapters for **sšm-nfr II** (scribal), **k3i (136)** (legal), **ty** (perhaps promoted due to royal favour), **ntr-wsr** (legal/scribal), **r'-špss** (legal/scribal) and **h'-mrr-pth** (legal). Several of these men held titles in the group related to the responsibilities of the overseer of works, such as **imy-r phw (ty and h'-mrr-pth)**, **smsw izt (ntr-wsr)** and **imy-r gs-pr (h'-mrr-pth)**. For **ty** and **ntr-wsr**, it is perhaps unlikely that the titles were held before promotion to the office of **imy-r k3t nbt (nt) nzwt**, as titles in other administrative areas are more prominent - these may have been granted

1 **Beamtentitel**, 92-105.

2 **JNES** 18 (1959), 265-6.

Chapter 5 - The Overseers of Works

Table 15

Principal Titles of Non-viziers who held **imy-r k3t nbt (nt) nzwt**

	1	2	3	4	5	6	7	8	9	10	11	12	13	14	15	16
ph-r-nfr (46)							X	0	0	2	X	X	X			
ddf-hr (168)					X			0	0	0				X	H	X
mry-ib (59)	X	X			X		X	0	0	0		X		X		X
3hi (1)						X	X	2	0	2		X				
s3t-htp (126)	X		X		X		X	0	0	0		X				X
d3ty (165)		X						0	0	0						X
'nh-hwfw (36)								0	0	0				X		
ny-'nh-r' (71)			X					4	0	0			X	X		X
'nh-irs (25)							X	2	0	0	X					
pr-sn (44)							X	0	1	0		X				
'nh-wsr-k3f (27)		X	X				X	3	0	0			X		H	
s3m-nfr II (130)								0	4	1	X					
ny-k3i-'nh (137)								0	0	0					X	
k3i (136)							X	7	2	2	X		X			
s3mw (127)	X	X	X		X	X		0	0	1	X					
ty (157)		X						0	2	1	X			X		
hn-k3 (97)							X	4	0	0	X					
ntr-wsr (91)			X				X	9	3	2	X		X			
iy (5)	X	X			X			0	0	0						
r'-špss (95)								10	3	2	X		X			
h'-mrr-pth (106)		X	X					4	0	2			X			
hwfw-htp (107)								0	0	0						
k3i (137)								0	0	1	X			X		
k3i-m-tnt (146)	X	X			X	X		0	0	0	X			X		X
'nh-izzi (26)	X	X			X	X		0	0	0	X			X		X
h3zi (98)			X					0	2	2			X			
s3bw; ibbi (116)			X	X				0	0	0	X					
ny-k3w-izzi (76)								0	0	0				X	X	
'nh-mry-r' (32)		X						0	0	0			X	X		
nhbw (90)			X					0	0	0			X	X		
pth-špss (53a)				X				0	0	0				X		

Key to Column Numbers:

- 1 **sd3wty ntr** ...
- 2 **imy-r m3'** and military titles, including **imy-r phw**
- 3 Titles using **qd**, **k3t**, and **smsw izt**, **imy-r gs-pr**
- 4 Titles using **hwmt**
- 5 Boat titles
- 6 Titles using **'prw/nfrw**
- 7 **wr md šm'w**
- 8 Number of Legal Titles
- 9 Number of Scribal titles
- 10 Number of Other High Offices
- 11 Titles with **wd(t)-mdw**
- 12 **rh nzwt**
- 13 **hry-tp nzwt**
- 14 **smr w'ty**
- 15 H = **h3ty-**, X = **h3ty-** and **iry p't**
- 16 Titles of "Kings's son"

along with **imy-r k3t nbt (nt) nzwt**. This may also be true of **h'-mrr-ptḥ**; he does however have more labour-related titles than the others, and so his career structure may be better described as legal/connected with the organisation of labour.

It is very difficult to suggest a career pattern for the remaining **imy-r k3t nbt (nt) nzwt**. From the lack of any other connection, one may place **ddf-ḥr** and **pr-sn** with those whose careers were concerned with the organisation of labour, although the former's position may have come about through his importance as a son of Khufu. The same may be said for **ny-'nh-r'**, although he was probably not a true king's son. The principal position of **s3bw; ibbi** and **ptḥ-špss; impy** was **wr ḥrp ḥmwt**. No other high priests of Ptah attained the office of overseer of works in the Old Kingdom, and so whether they gained this title by virtue of the traditional relationship of the **wr ḥrp ḥmwt** with craftsmen or by some other means is unknown. The high-ranking but otherwise uninformative titulary of **'nh-ḥwfw** suggests that his appointment as **imy-r k3t nbt (nt) nzwt** can only have been due to royal favour. For the remainder, one has to make the unsatisfactory suggestion that they were promoted either as a result of royal favour and/or by proven efficiency in the other high offices they held.¹

2. Legal and Scribal Titles

These titles are not particularly common; they are found most frequently with officials who held one or both of **imy-r ḥwt wrt** and **imy-r zš ' nzwt**. Such sporadic appearances of these titles suggest that they were not an important element in the titulary of a holder of **imy-r k3t nbt (nt) nzwt**. None at all appear after the end of the fifth dynasty.

3. Honorific Titles

Columns 12-15 of table 15 show the occurrences of the principal honorific titles. No one title stands out as being characteristic of **imy-r k3t nbt (nt) nzwt** for the whole period; a number of officials have no honorifics at all. From the first appearance of the title down to the later fifth dynasty, **rh nzwt** and **hry-tp nzwt** are the most frequent such titles. The status of **rh nzwt** in the fourth dynasty must have been higher than in the fifth and sixth, as it was held by two king's sons (**mry-ib** and **sš3t-ḥtp**, although not true 'princes') and the important official **ph-r-nfr**.

From the early fourth dynasty to the middle fifth there are six examples of **smr w'ty** in the table and two of **h3ty-**. The occurrence of the former title with **mry-ib** and **ny-'nh-r'** is doubtless connected with their status as king's sons, as is **h3ty-** in the titulary of **ddf-ḥr**. Although not a prince, **'nh-wsr-k3f** must also have been highly favoured to have held **h3ty-** - this is also suggested by the prominent location of his tomb at Abusir. It has

1 See also the breakdown of different types of overseers of works in de Cenival, **Chefs de Travaux**, 227-8.

been suggested above (page 205) that **ty** was another favoured individual, hence his title of **smr w'ty**; the same is probably true for **ny-k3i-'nh**. More instances of **smr w'ty** are found from the later fifth dynasty onwards. The title's occurrence with **k3i-m-tnt** and **'nh-izzi** must again be linked to their titles of **z3 nzwt**. It will be noted that, from a more general survey of Old Kingdom titles from this period, the title **smr w'ty** becomes more common with all categories of officials.

No one honorific title appears as being characteristic of **imy-r k3t nbt (nt) nzwt**, although **rh nzwt**, **hry-tp nzwt** and **smr w'ty** appear not infrequently. The rank of **imy-r k3t nbt (nt) nzwt** would thus seem to be similar to (or perhaps slightly lower than) that of **imy-r hwt wrt** and **imy-r zš 'nzwt**.

4. Titles of 'King's son'

The majority of titles incorporating the element **z3 nzwt** are to be found in titularies of fourth and early fifth dynasty date, before men of this rank were generally excluded from the administration. Of those indicated in column 6 of table 15, **ddf-hr** and **šš3t-htp**; **hti** were **z3 nzwt n ht.f**, while **ny-'nh-r'**, **k3i-m-tnt** and **'nh-izzi** were simply **z3 nzwt**. **mry-ib** and **d3ty** held both titles. **ddf-hr** was certainly a true king's son, as possibly was **d3ty**. The other two **z3 nzwt n ht.f** were almost certainly not true 'princes'; they possess very similar titularies, and could have been distant relatives of the king.¹ The two later fifth dynasty holders of **z3 nzwt**, **k3i-m-tnt** and **'nh-izzi**, illustrate a brief resurgence of the use of 'princely' titles for administrative officials.²

5. Other High Administrative Titles

The table on the next page shows that the only other high administrative title with which there appears to be a frequent association (for a time at least) is **imy-r zš 'nzwt**. This link may be due to a concentration of the offices of authorisations with the office of works,³ which prevailed for much of the fifth dynasty; from the latter part of that dynasty onwards however, the two offices were not held by the same man, with the exception of viziers. None of the other titles is found often enough for a pattern to be evident.

After the later fifth dynasty the non-vizierial **imy-r k3t nbt (nt) nzwt** held no additional high offices. This parallels the situation noted for **imy-r hwt wrt**, and emphasises the probability of a reform in the system of title holding in the later fifth dynasty.

1 The mother of **mry-ib** was **z3t nzwt nt ht.f** (LD II, 21).

2 Schmitz, *Königsson*, 30-2. These two and **ny-'nh-r'** can also be grouped together by virtue of having titles related to building work (*id.*, *ib.*, 88-90).

3 cf. Fischer, *OMRO* 41 (1960), 6.

7. Titles connected with Royal Institutions

The occurrences of these titles are as follows:

mry-ib (59)	hm-ntr hwf
'nh-wsr-k3f (27)	hm-ntr s3hw-r' m swt.f nbt
	shd w'b h'-b3-s3hw-r'
ny-k3i-'nh (75)	hm-ntr r' hwthr m st-ib-r'
	shd w'b w'b-swt-wsr-k3f
	shd w'b r' m nhn-r'
s3mw (127)	hm-ntr r' m st-ib-r'
ty (157)	see above page 207
hn-k3 (97)	imy-r h'wy-snfrw
s3bw; ibbi (116)	imy-ht hm-ntr nfr-swt-wnis
	imy-ht hm-ntr dd-swt-tti
	hm-ntr r' m nhn-r' / st-ib-r' /
	'szp-ib-r' / 3ht-r'
nhbw (90)	imy-r hnty-s mn-nfr-mry-r' ppy
	imy-r wpt nzwt mn-nfr-mry-r' ppy

It will be seen that the fifth dynasty examples were all men who held at most one other high administrative title, and it appears that the higher the official in that dynasty, the less likely he was to hold royal institution titles. It is possible that tenure of these titles may have influenced the location of the burials of **'nh-wsr-k3f**, **ny-k3i-'nh** and **hn-k3**, because, even though it is unlikely that these titles indicate actual service in a temple, part of the privilege they bore may sometimes have been burial near the pyramid of the relevant king.

The titles of **s3bw; ibbi** and **nhbw** reflect the later situation that important officials were often granted high-ranking titles at the pyramids of their kings. It is possible that **s3bw** 's sun-temple titles may belong to an earlier stage of his career, or he may have even acquired them with his many other religious titles.

mry-ib is the only **imy-r k3t nbt (nt) nzwt** to hold such a title in the fourth dynasty. There are few holders of the title **hm-ntr hwf** in that dynasty, and all may have been in some way related to Khufu.¹ **mry-ib** 's tenure of such a title is thus associated much more with his likely genealogy than simply his status as an official, although the two may be related.

8. Other Titles

Titles incorporating the group **wd(t)-mdw** are found quite frequently (thirteen officials - column 11 of table 15). Occurrences are principally of fifth dynasty date, with the very early exception of **ph-r-nfr**. These titles feature frequently in the titularies of men holding high offices; they were doubtless connected with the

1 Two other examples are **h'f-hwf** I (104), son of Khufu, and the unnamed woman, daughter of Khufu (?), on block Boston MFA 30.831 (unpublished).

execution of the high royal commands for which they were responsible.

There are also six examples of the title **hrp 'h**, extending from the later fourth to the mid-fifth dynasty. Most Old Kingdom examples of this title belong mainly to this same period and are found with high-ranking officials, but not necessarily those with important administrative offices.¹ The **imy-r k3t nbt (nt) nzwt** who hold this title are mostly the higher-ranking ones: **mry-ib**, **s33t-htp**, **ny-k3i-nh**, **ty**, **s3mw** and **k3i** (137). This serves to stress again the high rank of many of these title-holders.

B. **imy-r k3t (nt) nzwt**

1. Titles associated with the Organisation of Labour

Table 16 shows that titles connected with labour organisation (columns 1-7) are found in the titularies of many holders of **imy-r k3t (nt) nzwt**, notably **k3i-pr**, **h'f-hwfw II**, **dw3-r'**, **itti**, **itti**; **'nh-irs** and **k3i-h3f**.² The majority of these belong to the middle to later fifth dynasty. Many of the earlier examples have as their only possible such title **wr md sm'w**, and three (**snnw-k3i**, **k3i-tp** and **ny-k3w-r'**) none at all. This in itself is insufficient to differentiate these men from holders of **imy-r k3t nbt nt nzwt**, especially as several holders of that title held no offices related to the organisation of labour apart from **wr md sm'w**.

2. Legal and Scribal Titles

'nh-m'-k3i is the only man to possess a large number of legal titles, and this is very probably to be explained by his career as a legal official culminating in promotion to **imy-r hwt wrt**. **k3i-pr**'s large number of scribal titles is linked to his military ones. Otherwise, the limited number of scribal titles is coupled with the similar lack of legal ones. In general, the distribution of these two classes of titles is not very different from that noted for **imy-r k3t nbt (nt) nzwt**.

3. Other High Administrative Offices

Only **'nh-m'-k3i** held another such title, **imy-r hwt wrt**, and this is reflected in the low frequency of legal, scribal, granary and treasury titles in the titularies of the **imy-r k3t (nt) nzwt**. Titles with **w(t)-mdw**, found with holders of high offices, are found twice, once in the titulary of **'nh-m'-k3i** and also in that of **k3i-pr**. The latter does not hold one of the recognised high titles; however his tenure of the office **hrp pr-hd** may have qualified him for this title, as it is possible that this position may

1 cf. Helck, *op. cit.*, 32-3.

2 The following discussion will for the present ignore **ny-nh-r'** and **s3mw** who also held **imy-r k3t nbt (nt) nzwt**.

have been quite important in the early fifth dynasty (see below page 296).

Table 16

Principal Titles of holders of **imy-r k3t nzw**t

	1	2	3	4	5	6	7	8	9	10	11	12	13	14	15	16
k3i-'pr (139)		X				X	X	3	11	0	X					
sšm-nfr I (129)							X	1	1	0		X	X			
snnw-k3i (119)								0	1	0		X				
ddf-hnmw (169)							X	0	0	0		X				X
d3ty (166)							X	0	0	0						
d3ty (164)							X	0	0	0						
h'f-hwfw II (105)		X					X	2	0	0						X
ny-k3i-'nh (75) *								0	0	0					X	
sšmw (127) *	X	X			X	X		0	0	1	X					
k3i-tp (152)								0	0	0		X				
'nh-m-'k3i (31)							X	7	1	1	X			X		
dw3-r' (162)			X				X	0	0	0		X				
itti (20)	X				X			0	0	0		X				
itti; 'nh-irs (21)		X	X				X	1	0	0						
ny-k3w-r' (79)								0	0	0		X				
r'-wr III (92)		X						2	0	0						
'nh-ir-pt h (24)				X				0	0	0						
k3i-'h3f (139a)		X					X	0	0	0						X

* indicates also holder of **imy-r k3t nbt (nt) nzw**t

Key to Column Numbers:

- 1 **sd3wty ntr** ...
- 2 **imy-r mš'** and military titles, including **imy-r phw**
- 3 Titles using **qd, k3t, and smsw izt, imy-r gs-pr**
- 4 Titles using **hmwt**
- 5 Boat titles
- 6 Titles using **'prw/nfrw**
- 7 **wr md šm'w**
- 8 Number of Legal Titles
- 9 Number of Scribal titles
- 10 Number of Other High Offices
- 11 Titles with **wd(t)-mdw**
- 12 **rh nzw**t
- 13 **hry-tp nzw**t
- 14 **smr w'ty**
- 15 H = **h3ty-**, X = **h3ty-** and **iry p't**
- 16 Titles of "Kings's son"

4. Honorific Titles

Only two such titles are in evidence in the titularies of the *imy-r k3t (nt) nzwt*, *rh nzwt* and *hry-tp nzwt*. The latter title appears only twice, with *s3m-nfr I* and *'nh-m-'-k3i*. The titulary of the former contains the scribal title *imy-r z3 hryt-' nzwt*, which could be of sufficient importance to warrant the rank of *hry-tp nzwt*; he was also *hm-ntr hqt* and *ht h3*, which have been seen above to be almost always found with officials who hold this honorific title. *'nh-m-'-k3i* held *hry-tp nzwt* by virtue of being a legal official.

The seven occurrences of *rh nzwt*, of which *s3m-nfr I* is also one, show this title to be more typical of holders of this office than *imy-r k3t nbt (nt) nzwt*, and is suggestive of an overall lower rank for the holders of *imy-r k3t (nt) nzwt*.

5. Titles of 'King's Son'

ddf-hnmw and *h'f-hwfw II* were *z3 nzwt*. The former held this title together with *rh nzwt* as did *mry-ib (imy-r k3t nbt (nt) nzwt)*. Both men were presumably not true king's sons, and their titles should thus be seen as very important honorific ones, particularly as *h'f-hwfw* made great play of the fact that he was *im3hw* before several kings.¹ That some relationship existed between tenure of the titles with *z3 nzwt* and the Overseers of Works is evident from the frequency with which they appear together (see tables 15-16), especially when compared to *imy-r hwt wrt* and *imy-r z3 ' nzwt*.² That there are fewer of these titles with the *imy-r k3t (nt) nzwt* further suggests that it was less important than *imy-r k3t nbt (nt) nzwt*.

The example of *k3i-'h3f* is very different; his title of *z3 nzwt n ht.f* seem to belong in part to a resurgence in the cult of Sneferu in the late Old Kingdom, if Schmitz's date is correct.³

6. Religious Titles

Only one lector priest is found (*r'-wr III*) who did not have the ranking title *smr w'ty* as did the comparable holders of *imy-r k3t nbt (nt) nzwt*. A religious title that appears more often with *imy-r k3t (nt) nzwt* than with *imy-r k3t nbt (nt) nzwt* is *w'b nzwt*: *h'f-hwfw II*, *k3i-tp* and *'nh-m-'-k3i (snnw-k3i; kki and k3i-tp were hrp w'b nzwt)*; *s3mw* was the only *imy-r k3t nbt (nt) nzwt* to bear this title. *w'b nzwt* is very frequently associated with the title of *rh nzwt*, which is also more frequent in the titularies of *imy-r k3t (nt) nzwt* than *imy-r k3t nbt (nt) nzwt*. The religious titles of *imy-r k3t (nt) nzwt* are clearly less important than those held by *imy-r k3t nbt (nt) nzwt*.

1 Simpson, *Giza Mastabas III*, fig. 45.

2 cf. Schmitz, *Königsohn*, 88-90.

3 *op. cit.*, 150, 155-6.

7. Royal Institution Titles

The following list of Royal Institution titles shows that they are more frequent in the titularies of these officials than *imy-r k3t nbt (nt) nzwt*.

<i>snrw-k3i</i> (119)	<i>imy-r niwt 3ht-hwfw</i>
<i>h'f-hwfw</i> II (105)	<i>hm-ntr hwfw</i>
<i>k3i-tp</i> (152)	<i>hm-ntr r' m st-ib-r'</i>
<i>'nh-m-'-k3i</i> (31)	<i>hm-ntr hwfw</i>
	<i>hm-ntr mn-swt-ny-wsr-r'</i>
	<i>hm-ntr r' m nhn-r'</i>
	<i>hm-ntr s3hw-r'</i>
<i>dw3-r'</i> (162)	<i>hm-ntr r' m nhn-r'</i>
	<i>hm-ntr snfrw</i>
	<i>imy-r h'-snfrw</i>
	<i>imy-r h'wy-snfrw</i>
	<i>hnty-s w'b-swt-wsr-k3f</i>
	<i>w'b w'b-swt-wsr-k3f</i>
<i>ny-k3i-'nh</i> (75)	See page 227 above
<i>s3mw</i> (127)	See page 227 above
<i>itti</i> (20)	<i>shd w'b wr-h'f-r'</i>
<i>ny-k3w-r'</i> (79)	<i>hm-ntr nfr-dd-k3-r'</i>
<i>k3i-'h3f</i> (139a)	<i>imy-r [h'(wy)] snfrw</i>
	<i>hm-ntr snfrw</i>
	<i>hm-ntr hr-snfrw ?</i>

One important observation is that in the case of *ny-k3i-'nh* (holder of both *imy-r k3t nzwt* and *imy-r k3t nbt (nt) nzwt*), the priesthoods in this list occur only in the same inscription as does *imy-r k3t nzwt*,¹ while *imy-r k3t nbt (nt) nzwt* appears on a drum with the titles *hrp 'h* and *smr w'ty* which do not appear elsewhere.² It is thus possible that the titles of *ny-k3i-'nh* fall into two groups (see next page).

8. Comparison with *imy-r k3t nbt (nt) nzwt*

The importance of *imy-r k3t (nt) nzwt* is clearly less than that of *imy-r k3t nbt (nt) nzwt*, best illustrated by the honorific and religious titles. It is very possible that the number of royal institution titles may vary in relation to the rank of the official, with the less important men possessing more of them. This is clearly only true for the fifth dynasty, when such titles are anyway less prominently placed in titularies.³

The implication from this is that *imy-r k3t (nt) nzwt* represents a position not unlike but inferior to that of *imy-r k3t nbt (nt) nzwt* in the fifth dynasty. It is true that some holders of the latter title (*pr-sn* (44) for example) have titularies that are

1 Lintel BM 1275, *BM Stelae I*², pl. XXI (1).

2 Petrie-Murray, *Memphite Tomb Chapels*, pl. III.

3 Baer, *Rank and Title*, 267-72.

rather similar to those of **imy-r k3t (nt) nzwt** (for example, **snw-k3i**; **kki** and **k3i-tp**), but the rest of the evidence suggests that they may have represented two different positions within the same administrative area.

As for the manner in which these titles are written, the inscriptions of most officials contain only one example of the title **imy-r k3t (nt) nzwt**, and it could conceivably be an abbreviation for **imy-r k3t nbt (nt) nzwt**. However, in the tomb of **h'f-hwfw II** it appears many times, and one would surely expect to find at least one example of **imy-r k3t nbt (nt) nzwt** if that is what **imy-r k3t (nt) nzwt** represented. As noted earlier on, **ny-k3i-'nh** and **s3mw** held (or at least show writings of) both titles. It is probable that the titular of **ny-k3i-'nh** can be split into two non-overlapping parts. As the title **smr w'ty** appears only in the context of **imy-r k3t nbt (nt) nzwt**, it suggests that **ny-k3i-'nh** may have received a promotion from **imy-r k3t (nt) nzwt** to **imy-r k3t nbt (nt) nzwt**, and acquired as well a high honorific title.¹

Since the two overseer of works titles in the tomb of **s3mw** both derive from his monolithic false door, we cannot split them in quite the same way. However, since **imy-r k3t (nt) nzwt** appears to the left of the central niche and **imy-r k3t nbt (nt) nzwt** to the right, we can perhaps divide the texts so as to show the titles on the right as a later stage of the owner's career than the titles on the left.² This again suggests that **imy-r k3t (nt) nzwt** and **imy-r k3t nbt (nt) nzwt** were different.

C. **imy-r k3t nbt**

1. Summary of Titularies

Six instances of this title are known in the Old Kingdom, one of which belongs to a vizier. The time-span of these officials is from the end of the fourth to the end of the sixth dynasties, and they thus seem to be confined to no particular period unlike the **imy-r k3t (nt) nzwt** who were mainly of the fifth dynasty. It is impossible to split the titles of the vizier **h'-b3w-hnmw; biw** into pre- and post-vizierial stages, and he will thus be omitted from table 17 and the ensuing discussion; with **impy**, we can only use the title shown with his appearance on the walls of the mortuary temple of Pepy II.

As far as most of the fifth to sixth dynasty examples are concerned, there is certainly some connection with other posts related to labour and expedition organisation, although the title of **imy-r m3'** is not found. Scribal or legal titles are in evidence in the titularies of **h'-mrr-ptb**, **htp-hr-n-ptb** and **q3r**.

iwn-r', the earliest example, has no titles that associate him to the others or indeed to labour organisation. He was of higher rank than the rest, and his involvement with the title of **imy-r k3t**

1 Strudwick, **GM 77** (1984), 43 (a).

2 *id.*, *ib.*, 46 (b).

nbt must have come about simply from royal favour, since he was a true king's son.

Apart from those of **iwn-r'**, the only honorific title found is **hry-tp nzw**. The holders of **imy-r k3t nbt** did not have a clearly different rank from that of the **imy-r k3t nbt (nt) nzw** as was the case with **imy-r k3t (nt) nzw**. If the rank and other features were similar, there would be more chance that the title was a variant writing of **imy-r k3t nbt (nt) nzw** rather than a separate office.

Another feature that differentiates these men from the **imy-r k3t (nt) nzw** is the low number of titles connected with royal institutions. These are only found with **q3r**, and include very important offices connected with the Giza pyramids and that of **hnty-s** at the pyramid of Pepy I in whose reign he lived. This latter title was borne by **nhbw** (90) (holder of **imy-r k3t nbt (nt) nzw**), and no similar titles appeared with the more lowly-ranking **imy-r k3t (nt) nzw**.

Table 17

Principal Titles of non-viziers who held **imy-r k3t nbt**

	1	2	3	4	5	6	7	8	9	10	11	12	13	14	15	16
iwn-r' (8)								0	1	0				X	X	X
h'-mrr-pt (106) *		X	X					4	0	2		X				
htp-hr-n-pt (100)		X		X			X	3	2	0	X					
q3r (135)			X			X		3	7	0		X				
imy (62) *			X					0	0	0						

* indicates also holder of **imy-r k3t nbt (nt) nzw**

Key to Column Numbers:

- 1 **sd3wty ntr** ...
- 2 **imy-r m3'** and military titles, including **imy-r phw**
- 3 Titles using **qd, k3t**, and **smsw izt**, **imy-r gs-pr**
- 4 Titles using **hmwt** 5 Boat titles
- 6 Titles using **'prw/nfrw** 7 **wr md sm'w**
- 8 Number of Legal Titles 9 Number of Scribal titles
- 10 Number of Other High Offices 11 Titles with **wd(t)-mdw**
- 12 **rh nzw** 13 **hry-tp nzw**
- 14 **smr w'ty**
- 15 H = **h3ty-**, X = **h3ty-** and **iry p't**
- 16 Titles of "Kings's son"

2. Relationship to **imy-r k3t nbt (nt) nzwt**

It would seem that it is very likely that there was no difference in the functions of holders of **imy-r k3t nbt** and those who held **imy-r k3t nbt (nt) nzwt**. The appearances of **imy-r k3t nbt** in the titularies of **h'-mrr-ptḥ** and **impy** are probably abbreviated writings as they hold **imy-r k3t nbt (nt) nzwt** elsewhere (see above page 221). That of **ḥtp-ḥr-n-ptḥ** appears at the bottom of a column of text immediately above his name, which renders probable an omission of the **nzwt** element for reasons of space. The title **imy-r k3t nbt** of **iwn-r'** occupies all of a vertical column on the drum; insufficient space may account for the omission of **nt nzwt**. This may also be true for the example of **h'-b3w-hnmw**, written inside a small box on the wall of his burial chamber.

The examples from the tomb of **q3r** are more problematical. Two further titles in his tomb incorporate the group **k3t nbt** (**ḥry-sšt3 n k3t nbt**, **z3b imy-r zš n k3t nbt**), again with no sign of the word **nzwt**; there would seem to have been space available for this group if needed in most cases. We view this example as an abbreviation with far more hesitation.

Table 18

Principal Titles of holders of **imy-r k3t**

	1	2	3	4	5	6	7	8	9	10	11	12	13	14	15	16
k3i-'pr (138)								0	0	0		X				
bb-ib; sndm-ib (43)								X	0	0	0		X			
s'nh-n-ptḥ (118)								X	5	3	0		X			
Name Lost (173)				X					0	0	0					X
nhbw (90) *				X					0	0	0		X			X
mry-ptḥ-mry-r' (60)									0	0	0					

* indicates also holder of **imy-r k3t nbt (nt) nzwt**

Key to Column Numbers:

- 1 **sd3wty ntr ...**
- 2 **imy-r mš'** and military titles, including **imy-r pḥw**
- 3 Titles using **qd, k3t,** and **smsw izt, imy-r gs-pr**
- 4 Titles using **hmwt**
- 5 Boat titles
- 6 Titles using **'prw/nfrw**
- 7 **wr md šm'w**
- 8 Number of Legal Titles
- 9 Number of Scribal titles
- 10 Number of Other High Offices
- 11 Titles with **wd(t)-mdw**
- 12 **rḥ nzwt**
- 13 **ḥry-tp nzwt**
- 14 **smr w'ty**
- 15 H = **ḥ3ty-'**, X = **ḥ3ty-'** and **iry p't**
- 16 Titles of "Kings's son"

D. *imy-r k3t*

On page 221 it was argued that the examples of this title in the tombs of 'nh-m-'hr; zzi (30) and nhbw (90) represent compressed writings of *imy-r k3t nbt (nt) nzwt*. Table 18 omits the former official as it is currently impossible to discern his pre-vizierial titular. The short titularies of the officials holding *imy-r k3t* (with the exception of nhbw) provide little useful information. Only the title *wr md šm'w* indicates any possible involvement with the organisation of labour, but in this respect these officials differ little from such *imy-r k3t nbt (nt) nzwt* as *pr-sn* (44). No consistent occurrences of legal and scribal titles can be discerned, nor are any high administrative titles evident. The most consistent feature is that the three fifth dynasty officials all held the title of *rh nzwt*, which title is more often found with *imy-r k3t (nt) nzwt* than *imy-r k3t nbt (nt) nzwt*. They do not seem to have held any royal institution titles.

Due to the relative infrequency of the title, conclusions are difficult to draw, and affinities may be observed with other officials who held *imy-r k3t nbt (nt) nzwt* or *imy-r k3t (nt) nzwt*. The title of nhbw is probably an abbreviation, and, by analogy, the same may be said for his brother (173); whether all of the others are so to be understood is unclear, as they do not seem necessarily to be fitted into a cramped space, and indeed there would have been room for further elements of *imy-r k3t nbt (nt) nzwt*. That of *mry-ptḥ-mry-r'* could be an abbreviation, appearing as it does in the address of a royal decree where space was at a premium. Also, the title of overseer of works in the tomb of *sndm-ib; inti* (120) is always given as *imy-r k3t nbt nt nzwt* with this one exception:

iw ḥm.i rh ḥmw.t.k r imy-r k3t nb ḥpr m t3 pn r dr.f

My majesty knows that your craftsmanship (is better) than (that of) any *imy-r k3t* who has existed in this entire land.¹

Here the king (Djedkare) is clearly referring to *sndm-ib*'s capacity as *imy-r k3t nbt nt nzwt*, but nevertheless shortens the title to the minimum, rather as we are using 'overseer of works' in preference to a longer translation. This shows how *imy-r k3t nbt (nt) nzwt* can be abbreviated, and makes the example of *mry-ptḥ-mry-r'* (at least) all the more likely as an abbreviation as it also appears in a text mentioning the king.

However, if the title is not always an abbreviation, then it must represent a function about the work of which nothing is known. No other overseer of works would seem to have such a lowly title as *imy-r pr* found in the titular of *k3i-'pr*, and so it may even be associated with some form of non-royal work, if indeed it had a separate existence.

1 Urk. I, 63.6

E. Conclusions on Titularies

From the above discussion a form of typical titulary for an overseer of works has evolved, with the distinctive features of further titles connected with labour organisation. Of the several forms of the title, it is suggested that only one of them (*imy-r k3t (nt) nzwt*) was a distinct but related title, the rest being mainly abbreviated writings for *imy-r k3t nbt (nt) nzwt*.

The latter title appears at the beginning of the fourth dynasty and exists at least into the First Intermediate Period. The related form (*imy-r k3t (nt) nzwt*) exists only for the duration of the fifth dynasty, although with one isolated example at the end of the Old Kingdom.

The writings of these titles do not appear to vary a great deal from one period to the next. The greatest degree of variation is found in the group *nbt nt*. Most commonly all these elements are included in some form or other, the variants of *nbt nt* being written

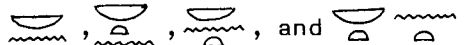
ten . The writing of these two

words using only one *t* is the most frequent from the middle of the fifth dynasty onwards. As might be expected, the genitive element *nt* is occasionally omitted, mainly in early examples, such as *h'f-minw* (103), *3hi* (1) and *s3t-htp* (126). Sometimes the group *nzwt* is honorifically transposed; unlike *imy-r z3 ' nzwt*, such transposition is rare and the group is nearly always written in full (exceptions: for example, *h'f-minw* (103), *3hi* (1), *'nh-hwfw* (36), *'nh-irs* (25), *s3m-nfr* II (130), *ny-k3i-'nh* (75) and *hn-k3* (97)). The latter date to the period before the middle of the fifth dynasty, and this serves as a very rough guide for a date.

The same broad orthographical rules are followed in the writings of *imy-r k3t (nt) nzwt* - the examples before the mid-fifth dynasty show a variety of positions for the *nzwt* group, and the *nt* element is occasionally omitted.

The Viziers

Of those viziers who hold an overseer of works title, only one does not hold *imy-r k3t nbt (nt) nzwt* but one of the shorter forms. This is *h'-b3w-hnmw*, but his title of *imy-r k3t nbt* is almost certainly an abbreviation for the longer title (page 234). These arguments are further strengthened by the fact that he would otherwise be a unique exception to the general rule, and so *imy-r k3t nbt (nt) nzwt* must have been the intention.

A number of viziers held titles which can be in some way connected with the organisation of labour. However, very many of them can be so considered in the broadest sense only, such as *imy-r gs(wy)-pr* and *wr md 3m'w*, and there seems to be no correlation between the holding of such titles and tenure of *imy-r k3t nbt (nt) nzwt* - in particular, *imy-r gs(wy)-pr* could be considered as sufficiently important to warrant being an important part of any vizierial titulary. Evidently, the presence of the title *imy-r k3t nbt (nt) nzwt* emphasised the holder's overall control in matters of

labour-organisation.

Only **ss3t-htp** (126), **k3i** (136), **r'-špss** (95) and **impy** (62) certainly held the title of overseer of works before their promotion to the vizierate, although it seems very probable that, on the analogy of their relative **nhbw** (90), the same was true for **sndm-ib; inti** (120) and **sndm-ib; mhi** (121) and **hnmw-nti** (113).

The Organisation and Functions of the Overseers of Works

A. The Organisation of the Overseers of Works

We have to consider three principal groups of officials in this section: the viziers with the title **imy-r k3t nbt (nt) nzwt**, the non-viziers with that title, and the non-viziers holding the other offices, principally **imy-r k3t (nt) nzwt**. It is clear that these groups were to a large extent contemporary; their approximate distribution by date is given in table 19.

Table 19

Distribution of Overseers of Works by date

Period (Years)	1	2	3	4
Early - mid 4th dynasty (70)	5	2	0	0
Mid 4th dynasty - early 5th dynasty (55)	3	8	2	1
Mid - end 5th dynasty (85)	14	16	14	6 ^a
Early - mid 6th dynasty (65)	6	4	1	6
Mid 6th dynasty - end Old Kingdom (100+)	8 ^b	1	1	3 ^b

(All period lengths are very approximate)

Key to Columns:

- 1 Vizierial holders of **imy-r k3t nbt (nt) nzwt**
- 2 Non-vizierial holders of **imy-r k3t nbt (nt) nzwt**
- 3 **imy-r k3t (nt) nzwt**
- 4 Others (including possible abbreviations)

- a. Includes two provincial examples
- b. Includes one provincial example

After its inception, the office of **imy-r k3t nbt (nt) nzwt** was held for the first part of the fourth dynasty mainly by members of the royal family, principally viziers, with the exception of **ph-r-nfr** (46). It is impossible to tell whether any of these viziers held **imy-r k3t nbt (nt) nzwt** before their promotion. For the remainder of the dynasty there is more evidence of non-royal and non-vizierial holders; in fact there is no certain example of a

fourth dynasty vizier with the title after **h'f-minw** (103). Only one member of the family of Khafre held an important position with regard to the organisation of labour, and he was not a vizier (**iwn-r'** (8)); there was also one very junior son of Khufu (**d3ty** (165)). For this period then, the control of the office of works was in the hands of several non-vizierial **imy-r k3t nbt (nt) nzwt**.

After **iwn-r'** (8) it appears that no true king's sons ever held this title again. In the early fifth dynasty, before the reign of Neferirkare, there were two vizierial holders (**s33t-htp; hti** (126) and **b3-b3f** (42)) and several non-viziers. Holders of the title **imy-r k3t (nt) nzwt** also appear for the first time. It is thus evident that at that time there could have been three contemporary holders of overseer of works titles - a vizier with **imy-r k3t nbt (nt) nzwt**, an **imy-r k3t nbt (nt) nzwt** who was not a vizier, and an **imy-r k3t (nt) nzwt**.

The probable administrative reform of the reign of Neferirkare,¹ which may have seen the introduction of (among other titles) **imy-r hwt wrt 6** and **imy-r zš ' nzwt**, seems to have had little impact on the organisation of the overseers of works. For the remainder of the fifth dynasty, there are broadly similar numbers of each type of overseer of works, suggesting that the tripartite division of this office was maintained. Only two viziers in this period certainly held the office of **imy-r k3t nbt (nt) nzwt** before their promotion (**k3i** (136) and **r'-špss** (95), and it is unknown whether the latter continued to hold this office as vizier); the division of the titulary of **s3m-nfr III** (131) can be used to show that some viziers did not hold the title prior to their promotion.

There is only one possible (early) sixth dynasty example of a holder of **imy-r k3t (nt) nzwt**, and it is likely that this office ceased to exist in that period.² Overall the number of men who held titles associated with the organisation of labour is reduced; the figures in table 19 suggest a contemporary vizier and non-vizier each holding **imy-r k3t nbt (nt) nzwt**. After the reign of Pepy I, all the attested **imy-r k3t nbt (nt) nzwt** were also viziers; that at least one of these held the office in an earlier stage in his career is evident from the depiction of **impy** (62) in the mortuary temple of Pepy II without the title of **t3yty z3b t3ty**. It cannot be established with any certainty, but perhaps this title was only given to men at that time who were destined for the vizierate, in the manner of **imy-r zš ' nzwt** (above page 208). In this period is found the only occurrence of a holder of **imy-r k3t nbt nt nzwt** in the provinces, the vizier **ppy-nht** at Abydos.

1 Baer, *Rank and Title*, 296.

2 The exception to this is **k3i-'h3f** (139a). Accepting Schmitz's date for the present, there seems to have been a group of officials buried at Dahshur at the end of the Old Kingdom who exhibit unusual title sequences; it is possible that they form a collective exception to the normal patterns of title-holding. If indeed they are as late as the First Intermediate Period, then there is no reason why the rules formulated for the Old Kingdom should apply at all.

The sixth dynasty is thus marked by a gradual reduction in the number of contemporaneous holders of *imy-r k3t nbt (nt) nzwt*. The office was obviously affected by the same administrative change that was noted with *imy-r hwt wrt* and *imy-r zš ' nzwt* at the end of the fifth dynasty, which had the result of reducing the number of contemporary holders and confined it to men of higher rank; eventually the title reposed with the vizier only.

These numerous overseers of works cannot all have performed the same function. Smith is aware of this problem and suggested that each man would have been in charge of a different building project or the like, and that their functions were restricted geographically.¹ In fact, a new instance of the title could have been created for each task. It is clear from the biographies of members of the *sndm-ib* family (for which see further below) that there was more building work being carried out in the Old Kingdom than is evident from present remains.²

Kanawati has discussed the probable duality of overseers of works (and viziers) in the reign of Teti.³ He suggests that the divisions of responsibility between the two may have been on a geographical basis, quoting the titles with the phrase *t3 r dr.f* of *k3i-gmni* (151) and *'nh-m-'-hr* (30). This is not an unreasonable suggestion if, as seems probable, there were two contemporaneous viziers, but he does not fit into this scheme the non-viziers, although admitting their existence.⁴ Presumably one non-vizier at least would be needed to assist each pair of viziers as the latter had many other responsibilities.

A geographical division of responsibility may very well explain the multiplicity of overseers of works. Two of the very rare overseers of works buried outside the memphite region in fact stress their involvement with provincial works: both *k3i-hnt* 's buried at Hemamiya held the title *imy-r k3t m sp3wt hrywt-ib (šm'w)*. It should be noted that there is no trace of *nbt nt nzwt*, suggesting perhaps that they may have held their authority over a restricted area. The rarity of provincial overseers of works and of qualifications to the titles such as seen at Hemamiya suggests that there must have been other men in charge of works in the provinces who did not specify it in their titles and were buried in the memphite region; this may explain the role of many of the non-

1 **Sculpture**, 357.

2 The constructions from the memphite area are the clearest evidence of Old Kingdom building work. Less obvious remains are the Old Kingdom 'dam' in the Wadi Garawi near Helwan, possibly built to trap water for workmen in the nearby quarries (Murray, **BIE** 28 (1947), 33-43), and various works at provincial cult-temples: at Koptos (from the decrees), Abydos (collection of material in **PM** 5, 40-1), and Karnak (various evidence, see Daumas, **BIFAO** 65 (1967), 206-9, 212-4), to name three important examples.

3 **Governmental Reforms**, 25-7.

4 **op. cit.**, 39 n. 44. There seem to be two such non-viziers from the reign of Teti, *s3bw*; *ibbi* (116) and *ny-k3w-izzi* (76).

vizierial **imy-r k3t nbt (nt) nzwt** or **imy-r k3t (nt) nzwt**. Provincial and memphite divisions would be the most logical explanation for such multiplicity.

Part of the reduction in numbers of overseers of works in the sixth dynasty may be as a result of the expansion of local provincial government. In particular, the disappearance of non-viziers (with the exception of those destined for the vizierate) from among the holders of **imy-r k3t nbt (nt) nzwt** after the reign of Pepy I may coincide with the developments in provincial administration undertaken from the reign of Merenre onwards.¹ Given the extent of activities of these provincial officials,² it would hardly be surprising that they dealt with works in their nomes, although it is generally not specified in titles in the Old Kingdom.³ The only Old Kingdom provincial holder of **imy-r k3t nbt nt nzwt** was a vizier, **ppy-nht** of Abydos, and his tenure of this office is doubtless to be associated with his vizierate, paralleling the situation evident in Memphis.

B. The Functions of the Overseer of Works

The principal sources for further information about these titles are the biographies of the **sndm-ib** family, notably **sndm-ib**; **inti** (120) and **nḥbw** (90). It is clear that this family were builders first and foremost, and it is very probable that they all held the title **imy-r k3t nbt nt nzwt** before they reached the vizierate, with the exception of **nḥbw**, who did not reach that office. However, only **impy** (62) is clearly attested with the title of overseer of works both before and after his promotion.

The works referred to in the biography of **sndm-ib**; **inti** were carried out during his vizierate, and the following sections from it are the most relevant to the study of the organisation of labour:

- 1 Urk. I, 60.16-61.1:- **iw m3.n. ḥm.i md3t.k tn irt.n.k r rdit rḥ ḥm.i ḥt nb(t) ntt irt.n.k m //// zš n mrt-izzi ntt ḥr š n pr-ʿ3.**

My majesty has seen this your report which you have made in order to let my majesty know everything which you have done in //// writing for the **mrt**-temple of Izezi which concerns the workshop of the palace.

- 1 cf. Kanawati, **Governmental Reforms**, 44 ff.
 2 cf. those of **mry-r'-nfr**; **q3r**, Urk. I, 254-5.
 3 There is some evidence that it may have been so before the reign of Merenre: in the biography of **izi** of Edfu, the deceased says **rs.kwi ḥr k3t nbt nt nzwt ipt m sp3t.i** - 'I was vigilant concerning all the works of the king reckoned in my nome' (Edel, **ZAS** 79 (1954), 13 (line 9), 17). The First Intermediate Period titles of **tmrry** (table 14) attest a very localised overseer of works at a slightly later period.

- 2 Urk. I, 62.1:- dd.n.k hr hm.i wnt.k r irt š hft ddt m stp-z3.

You have said to my majesty that you will do the craftwork in accordance with whatever is said in the palace.

- 3 Urk. I, 62.8:- ... r ntt ddt imy-r k3t nbt nt nzwt hryw-'.

... to the effect that whatever the imy-r k3t nbt nt nzwt says (happens ?) immediately.

- 4 Urk. I, 62.16-63.3:- iw m3.n hm.i šntw pn rdi.n.k int.f r si3 m stp-z3 n š n hwt-wsht n 'h n ny-hb-[sd]-izzi. sk tw dd.k hr hm.i wnt ir.n.k sw r ?mḥ? 1440 hft wddt n.k m stp-z3.

My majesty has seen this plan that you have caused to be brought to attention in the palace for the workshop of the 'broad court' for the palace ny-hb-sd-izzi. In fact (now) you tell my majesty that you have made it¹ to a length of 1400 (?) cubits in accordance with what was commanded you in the palace.

Text 3 shows the authority inherent in the position, while the others refer to particular works done for the king. It is actually unknown whether everything referred to was carried out in his capacity as imy-r k3t nbt (nt) nzwt, with the clear exception of text 3. In text 1, concerned as it is with a temple very closely associated with the king and with the stress on the royal nature of the report, sndm-ib may have been functioning as vizier and carrying out a very special concern on behalf of Izezi (see further below page 331).

The information from the biography of nḥbw (90) is a little less relevant here, as it is apparently an account of what he did as mdḥ qd nzwt m prwy. It is still one of the major primary sources about the organisation of labour:²

- 1 Urk. I, 215.11, 13:- iw h3b.n wi hm.f r hrp k3t nt mnw.f m iwnw [ir.n.i] rnpt 6 im hr hrp k3t.

His majesty sent me to direct the work of his monument in Heliopolis ... I spent six years there directing work.

- 1 The nature of the construction is unknown, although the context and dimensions might suggest some sort of supply canal for the palace (?). šntw as a 'plan' is attested from the Middle Kingdom (Wb. IV, 178-9), and this would seem correct here - sndm-ib has shown the king a plan and now has finished the project.
- 2 Full translation and commentary, Dunham, JEA 24 (1938), 1-7.

- 2 Urk. I, 216.1-4:- A list of his promotions:
 i. qd n 'š3t
 ii. šhd qd, imy-r qd, mty n z3
 iii. mdh qd nzwt, hry-tp nzwt
 iv. smr w'ty, mdh qd nzwt m prwy
- 3 Urk. I, 216.9-13, 15-6 217.2:- ir wn.i m-ht sn.i imy-r k3t
 ///// wn.i [hr] zš wn.i hr š'.f. ihr nd.tw n.f šhd n qd
 wn.i hr m3t.f. ihr nd.tw n.f imy-r qd wn.i m hmt.f. ihr
 nd.tw n.f mdh qd nzwt wn.i hr hq3 n.f niwt ... ihr nd.tw n.f
 smr w'ty mdh qd nzwt m prwy wn.i hr ip n.f išt.f nbt ... ihr
 nd.tw n.f imy-r k3t wn.i hr whm.f m mdt.f nbt im r hzt.f
 hr.s.

I worked under my brother, the imy-r k3t /////, I wrote, I carried his palette; when he was promoted to šhd n qd I carried his measuring rod; when he was promoted to imy-r qd I was his companion; when he was promoted to mdh qd nzwt I ruled the estate for him ... When he was promoted to smr w'ty and mdh qd nzwt m prwy, I reckoned all his possessions for him ... When he was promoted to imy-r k3t I repeated (carried out ?) everything he said to his satisfaction.

- 4 Urk. I, 219.15, 17-220.4:- iw h3b.n wi hm.f r hr[p k3t m]
 ///// iw h3b.n wi hm.f r hrp [k3t m] hwt-k3 ///// m t3-
 mh w gs-pr n hwt-k3 mhty '.i m niwt sp3wt m 3h-bity nt hr rsy
 '.i m mn-nfr-ppy iy.n.i 'rq.

His majesty sent me to direct works ///// ... His majesty sent me to direct works at the hwt-k3 //// in Lower Egypt, administrative area of the hwt-k3, with my northernmost authority in the town of the nomes of 3h-bity of Horus, my southernmost authority at the pyramid of Pepy I. I came away having finished.

- 5 Urk. I, 220.5-7:- iw //// n hwt-k3 //// im qdw h w z dy hwt
 iryt ndr n t3-mhw iy.n.i 'rq.

... of hwt-k3 therein built and wood placed on them which had been cut in Lower Egypt (?). I came away having finished.

- 6 Urk. I, 220.12-13:- ... n '3t n iqr.i hr.f ky mdh nzwt h3b.n
 hm.f hft gs-pr n pr-nzwt.

... through the greatness of my excellence towards him more than that of another mdh nzwt whom his majesty had sent in respect of the gs-pr of the pr-nzwt.

- 7 Urk. I, 220.14-221.1:- iw h3b n wi hm.f h3 mr n 3h-bity nt
 hr (r) š3d.f iw š3d.n.i sw n sw/3bd (?) 3 r iwt r hnw sksw
 hr mw.

His majesty sent me to lay out the canal of 3h-bity of Horus and (to) dig it. I dug it for three days/months and when I reached the residence it was full of water.

8 Urk. I, 221.6-9:- iw h3b n wi hm.f r //// hwthr m qis. iw ir.n.i š3d.n.i sw [r] hzt hm.f hr.s. ihr iw.i r hnw.

His majesty sent me to (do works for ?) Hathor in qis. I acted and dug it to the satisfaction of his majesty. Then I came back to the residence.

The juxtaposition of titles at the beginnings of these texts render it more likely that these building activities took place before nhbw's promotion to imy-r k3t nbt (nt) nzwt.¹ The last part of text 3 suggests that the overseer of works (in this case his anonymous brother (173)) was responsible as much for organising and ordering works as for executing them, and the implication of nhbw's statement is that as subordinate he was responsible for checking that the overseer's orders were carried out. These texts by their omission of many of the duties of the imy-r k3t nbt (nt) nzwt further suggest that the latter was not always the actual 'builder' of monuments. Text 4 shows that men were appointed to work in specific areas; it is always possible that when there was a multiplicity of overseers of works, division of responsibility was geographical.

In his inscriptions in the Wadi Hammamat, nhbw (called by his other name mry-ptḥ-'nh-mry-r') is given the titles imy-r k3t nbt nt nzwt, smr w'ty and mdḥ qd nzwt m prwy. The purpose of this Hammamat expedition is not given but it shows that the overseer of works did not always function simply as an administrator. This expedition may have been particularly special, as others of the same reign were not lead by so high an official.² The inscriptions do show that nhbw still held mdḥ qd nzwt m prwy alongside imy-r k3t nbt nt nzwt, and so it is not impossible that he did hold the latter office when the events described in his biography took place.

These texts of nhbw show that the office of overseer of works included responsibility for both expeditions and construction work, and the feature common to both aspects is the requirement of organising workforces.

One further text which should probably be grouped with the above is a fragment of the biography of an unnamed official, now in Cairo.³ This man's titles have not survived, but from the parallels with the inscriptions of nhbw it is perhaps likely that he was an overseer of works, or at least mdḥ qd nzwt. The principal similarity comes in the following phrase:

- 1 Against Kanawati, *Governmental Reforms*, 36.
- 2 cf. Urk. I, 91-2 and 94-5, where expeditions are lead by imy-r mš' and sd3wty ntr.
- 3 CG 1433; Urk. I, 86-7.

h3b wi hm.f r hrp k3t m hwt-k3 iry //// m r-3w ///.

His majesty sent me to direct works in the **hwt-k3** being made
 //// and in Tura.

The biography of **k3i-m-tnnt** (146) seems to contain accounts of building works, although we cannot tell whether they were carried out in his capacity as **imy-r k3t nbt nt nzwt**. The biography is too badly damaged to ascertain the exact content.¹

If Sethe's reconstruction of the biography of **dbhn** is correct, an **imy-r k3t nbt nt nzwt** may be seen at work in connection with a private tomb. This text is found:

irt wd n nzwt n imy-r [k3t nbt nt nzwt] ///// r irt.f iz n mh 100 m 3w.f r mh 50 m wsh[f] r mh /////.

Making a royal command to the **imy-r k3t nbt nt nzwt** //// to make it, namely a tomb of one hundred cubits long, fifty cubits in width and /// cubits ///.²

This is a clear instance of building work carried out under the supervision of this official on the express order of the king.

From the surviving biographical evidence, the principal association of the the titles under study was with building and the organisation of the workforces, which agrees with the conclusions obtained from analysis of the titularies.

One overseer of works appears in a royal decree, the **imy-r k3t mry-ptn-mry-r'** (60) in the Dahshur decree of Pepy I.³ He is here charged along with the vizier and several other individuals to ensure that the provisions of the decree are carried out. The concern of this text with the non-removal of the tenants and workers belonging to the pyramids of Sneferu for other tasks may explain why the most important individual in the area of labour organisation was mentioned. The non-appearance of overseers of works in other decrees may be associated with the latter's provincial origin; in addition, by the time of these decrees (reign of Pepy II and later), the responsibilities for labour-organisation outside the capital may not have resided with the overseer of works (above).

C. The uses of the word **k3t**

A wider range of uses of the word **k3t**⁴ and the phrase **k3t (nbt) (nt) (nzwt)** may be found in its uses outside titles.

1 **Urk. I**, 181-5; translation with restorations (some dubious), Schott, **Fs Otto**, 446-51.

2 **Urk. I**, 21.10-13.

3 Borchardt, **ZAS** 42 (1905), pl. I.

4 **Wb. V**, 98-101.

1. In reference to Building or Craft work

The above biographies have shown several such uses. Further references may be found, particularly in relation to work on royal pyramids.¹ A **z3 k3t** is found in the Abusir Papyri, and was perhaps concerned with reconstruction work.² There is one example which shows the word used in the work of a craftsman: on the false door of **m3-nfr** there are hieratic comments marking the various levels of work achieved.³

In the tomb of **ty** (157), above a man working on a statue is found the text **irt k3t in hmwt**, 'performing the work of the craftsman', and above one boring out a stone vessel **irt k3t n znht**, 'performing the work of the stone-borer'.⁴ A scene from the tomb of **ibi** at Deir el Gebrawi shows a man working on a statue with the caption **k3t m rw-3bw in gnwty**, 'work on the lion-statue (?) by the sculptor';⁵ the same tomb describes a scene of craftwork with **m33 k3t nbt m iz hmwt**, 'watching the work of the workshop'.⁶ Records of the work of craftsmen are also attested in the text **rdit zš n k3t hmwt nbt**.⁷

The word **k3t** is more frequently found followed by a specification of the exact craft, in the form **m k3t** 'in the work (or perhaps 'practice') of ...'.⁸

2. In Agricultural and Related Scenes

The word **k3t** is found in descriptions of the tomb-owner watching activities shown on the walls of his tomb. It appears most frequently in the combination **k3t sht**, perhaps in a general sense 'work of the countryside'.⁹ This is often followed by more specific descriptions of these activities, for example, **m33 k3t sht sht 3pdw h3m rmw '3 wrt** - 'Seeing the work of the countryside - the trapping of birds and the catching of fish in great quantities', and also **m33 k3t sht sk3 3zh hwi mhi šdt '3(w) hwi '3(w) zpwt h3h3** - 'watching

-
- 1 **Urk.** I, 18.12; 19.2; 20.2; 148.9; 149.5; also **Pyr.** 1649 c d.
 - 2 Posener-Krieger, **ArchAb** II, 450. The word **k3t** is also found in an unclear context, **id., ib.** I, 292-3 (document 70A).
 - 3 Berlin (East) 1108 - **AIB** I, 104 (A); **LD** II, 65.
 - 4 Both, Epron-Wild, **Tombeau de Ti** III, pl. CLXXIII.
 - 5 Davies, **Deir el Gebrawi** I, pl. XIV.
 - 6 **id., ib.**, pl. XIII; for a similar scene, Moussa-Altenmüller, **Nianchchnum**, Taf. 65.
 - 7 **id., ib.**, Taf. 61.
 - 8 Sculptors, **Urk.** I, 276.3; leather-workers, **Urk.** I, 22.8; manicurists, Moussa-Altenmüller, **op. cit.**, Abb. 3 (b, c); hairdressers, Mariette, **Mastabas**, 366; builders, **WZKM** 54 (1957), 93, Abb. 2. Also in connection with the construction of a tomb, Hassan, Giza IV, fig. 78, and the process of embalming, James, **Khentika**, pl. V (B12).
 - 9 For a discussion of this term with examples, see Montet, **Scènes**, 180-3.

the work of the countryside - ploughing, reaping, pulling flax, loading donkeys, driving donkeys on the threshing floor, winnowing'.¹ The recording of such activities is shown, as in the tomb of **wr-ir-n-ptḥ**, where the text **m33 ? zš n k3t sḥt**, 'watching the recording of the works of the countryside', appears beside a scribe performing the reckoning.² One unusual example refers to herdsmen and their produce: **prt m mḥit r ḥry-tp in mniw hn' k3t.sn k3w wrw**, 'coming forth from the marshes onto the higher ground by the herdsmen bringing their produce and their great bulls'.³ When works are referred to generally in such scenes, the phrase **k3t nbt** is used: **m33 k3t nbt nfrt nt sḥt irrt m niwwt.f**, 'seeing all the good works of the countryside carried out in his towns';⁴ also **///// k3t nbt nt t3-mḥw**, '///// all the works of Lower Egypt'.⁵

3. Other Uses

These references tend to be less specific than the foregoing, and are principally culled from royal decrees, especially those from Koptos. They are almost all connected with the exemptions that form the main subject of those decrees, and four different phrases are generally used: **k3t nbt nt nzwt**, **k3t nbt nt pr nzwt**, **k3t nt nzwt** and **k3t nbt**. The first three phrases are much more specific than the fourth. It seems that they were used to refer to particular exemptions while **k3t nbt** was used in a wider sense, presumably to cover anything that had been omitted elsewhere in the decree. Additionally the first three phrases are interchangeable, at least as far as these texts are concerned. This may be illustrated by comparing the very similar documents Koptos B and Koptos C:⁶ B has **k3t nbt nt pr nzwt** where C has **k3t nt nzwt**.⁷ These terms were clearly synonymous, and any differentiation between them recognised in the fifth dynasty - as seen in the titles **imy-r k3t nbt nt nzwt** and **imy-r k3t nt nzwt** - was no longer felt.

k3t nbt very often appears in lists in these documents, along with other duties from which the temple or its dependents are to be exempted, most frequently **mdd nb** or **sšm nb**.⁸ Other examples of general uses refer to works ordered to be done in Upper Egypt,

-
- 1 These are respectively from the tombs of **'nh-ppy ḥry-ib**, Blackman, **Meir IV**, pl. VIII, and of **šhm-'nh-ptḥ** (124), Simpson, **Sekhem-ankh-ptah**, pl. D, p. 10 and n. 38.
 - 2 BM 718, **BM Stelae I²**, pl. XXIX (2).
 - 3 Tomb of **ny-'nh-hnmw** and **hnmw-ḥtp**, Moussa-Altenmüller, *op. cit.*, Taf. 76-7.
 - 4 Tomb of **nfr-sšm-ptḥ** (87), Capart, **Une rue de tombeaux à Saqqarah**, pl. XC.
 - 5 Tomb of **ty**, Epron-Wild, **Tombeau de Ti II**, pl. CXXV.
 - 6 Koptos B: **Urk. I**, 280-3; Goedicke, **Königl. Dokumente**, Abb. 8. Koptos C: **Urk. I**, 284-8; Goedicke, *op. cit.*, Abb. 9.
 - 7 **Urk. I**, 281.9, 15 against 284.16 and 285.6.
 - 8 **Urk. I**, 286.14; 289.11,15; 290.9; 307.13.

found in these decrees¹ and the biography of wni.²

The general use of the phrase k3t nbt nt nzwt in a specific nome has been noted above (page 240, n. 3). An imy-r mš' refers to his business by the use of the word k3t: snknt pw m-' k3t b3k im, 'it is an ignoring of the business of this servant', in a letter to the vizier.³ The word may here be referring either to the specific quarrying nature of work at Tura or else generally - 'business'. One example exists of a use of k3t in the plural, although the First Intermediate Period date may explain this variation from the Old Kingdom form - sn-ndsw of Dendera says: iw z nb mkw n k3wt.f, 'Every man was protected for his works'.⁴

4. Further Observations

The above material, combined with the evidence gained from the biographies, shows the word k3t to be associated with buildings (and by implication the digging of canals), expeditions, agriculture and craftwork, together with less clearly-defined general uses. A common link between these activities is the organisation of workforces, which we have seen to be a clear function of many overseers of works. There seems to be no reason why the overall responsibility for the workforces needed for some agricultural tasks should not have laid with the overseers of works, especially the imy-r k3t nbt (nt) nzwt. These men do not seem to have been especially associated with agricultural organisation from their other titles, but the lack of any high title in the Old Kingdom specifically related to this area points to it having been controlled by one of the principal civil administrative offices, of which that of overseer of works would seem the most appropriate.

There is no direct evidence as to what these agricultural tasks were; the Old Kingdom probably employed a system of labour whereby people could be called in for 'corvée' labour when required,⁵ usually for the purposes of digging or carrying, and it is likely that these men were used for agricultural requirements as well as those of building work.⁶ Another pseudo-agricultural use of labour would be the maintenance (in addition to the building) of the irrigation system. Nothing is known about this in the Old Kingdom, but it must have existed in some form and would have required a large amount of organised labour to service it.⁷

1 Urk. I, 282.17.

2 Urk. I, 106.6, referring to what he did as imy-r šm'w.

3 Gunn, ASAE 25 (1925), 253, pl. 1a, line 6.

4 Fischer, Dendera, 154.

5 The exemptions of the various royal decrees are clearly intended to prevent this practice in particular cases.

6 cf. Hayes, A Papyrus of the Late Middle Kingdom in the Brooklyn Museum, 130-1. For a general account of 'corvée' labour, see Lexikon der Ägyptologie II, 333-4 ('Fronddienst').

7 Endesfelder, ZAS 106 (1979), 42-3; Butzer, Early Hydraulic Civilization in Egypt, 109-12; Schenkel, Die Bewässerungsrevolution im alten Ägypten, 25-9. Endesfelder (op. cit., 49)

More may be learnt about the manner of the organisation of works. It is evident from some passages in the royal decrees that the **k3t (nbt) nt (pr) nzwt** were carried out on orders which originated in any of the **iz n 'nzwt**, **iz n pr hryw-wdb**, **iz n pr md3t** or **iz n hry htm md3t**.¹ An actual office of works (**iz n k3t** or the like) is not attested in the Old Kingdom, perhaps because labour organisation was coordinated in the offices of the administrative department which required the work to be done.²

A similar conclusion may be deduced from further titles incorporating the word **k3t**. Such titles as reflect subordinate offices connected with the **k3t (nbt) (nt) (nzwt)** are extremely few in number, which contrasts sharply with the frequency of titles associated with the '**nzwt**, **hwt wrt**, granaries or treasuries. If labour-organisation did not exist as an independent administrative office, we might not expect to find many subordinate positions, which indeed is the case. There are six examples of titles beginning with **hry-s3t3**, split between **k3t nbt nt nzwt** and **k3t nbt**,³ with one **hry-s3t3 n k3t qd m ///**.⁴ Additionally there is an **imy-r ht wdt m k3t hft-hr**,⁵ and one **z3b imy-r z3 n k3t nbt**.⁶ Only three officials just noted were not also overseers of works, but one of them was a builder (**k3i-pw-nzwt**) and another (**pth-3pss**) a high priest of Ptah. There thus seems to be a strong link with the organisation of labour in the titularies of almost all these officials; equally importantly, these titles are few in number and attest very little in the way of bureaucracy for the branches of the administration headed by the overseer of works.

The Old Kingdom did not lack in offices relating to all grades and types of labour organisation. Instead of an established hierarchy linked by the use of the word **k3t**, it would seem that the offices under the supervision of the overseer of works kept their own identifying names which superficially do not always relate them to their superior. Such a solution to the problem of the lower offices suggests that labour-organisation was carried out very much

quotes the New Kingdom title **imy-r k3t m h'py '3**, and suggests that the overseers of works could have been involved with work on the Nile and irrigation, especially as there is no other evidence for central administrative involvement in irrigation work. This is very likely to have been true for the Old Kingdom also. A summary of other functions of the overseer of works in the New Kingdom will be found in de Cenival, **Chefs de Travaux**, 228-30.

- 1 **Urk.** I, 281.7-10, 13-16 and parallels 284.14-17 and 285.4-7.
- 2 cf. de Cenival, **op. cit.**, 226.
- 3 With the former element, **s3t-htp** (126) (LD II, 25) and '**nhi; inti** (Goyon, **K3mi** 15 (1959), pl. II); with the latter, **pth-3pss** (**BM Stelae** I², pl. XVII), **s3bw; ibbi** (116) (Mariette, **Mastabas**, 415) and **q3r; mry-r'-nfr** (135) (Simpson, **Giza Mastabas** II, fig. 20).
- 4 **k3i-pw-nzwt**, Kees, **WZKM** 54 (1957), Abb. 2.
- 5 **hzz** (98), Cairo, **CG** 1413.
- 6 **q3r** (135), Simpson, **op. cit.**, fig. 28.

on an *ad hoc* basis.

The office of overseer of works is therefore seen to be a very varied one, with a wide range of responsibilities, and was the most important position in the administration of work-organisation. There is no obvious equivalent to the wide range of very specific 'Overseer of works of' titles evident in the New Kingdom,¹ but this is not to say that certain officials were not so specifically attached, but rather that the current evidence does not support such a conclusion.

Conclusions

As seen with other titles, there was evidently a two-tiered structure of this office, it being held both by viziers and non-viziers for much of the Old Kingdom. This situation is however complicated by the existence of other forms of the title, although only *imy-r k3t (nt) nzwt* clearly had an independent existence.

No evidence exists for defining the different areas of responsibility of the contemporaneous non-vizierial holders of *imy-r k3t nbt (nt) nzwt* and *imy-r k3t (nt) nzwt*. As the latter title disappears in the sixth dynasty it is possible that it may have been connected with provincial administration, which was conducted on a more local basis in that period.

The prime concern of the office seems to have been the organisation of workforces, whether of builders, craftsmen or for agricultural work. It is thus possible that different title holders may have been responsible for different sections of this whole range of work. No centralised office of works seems to be recorded for the Old Kingdom, and consequently no clear hierarchy of titles is evident for this area of the administration; rather one has to put together all the titles relating to workforce organisation to determine the subordinate positions. We imagine that the overseer of works carried out the orders of the principal bureaucratic offices. A particular requirement may have materialised in one of these offices, for example, for men to attend to the organisation of irrigation works in a particular area. It would then be the function of the overseer of works to put together a body of men suitable for the work.

It is unclear how builders may have fitted into this pattern. They would have needed the semblance of a permanent department to be able to organise the architectural details of the projected construction, and then it would have been necessary to raise the required workforce. Whether they came directly under the supervision of the overseer of works is not clear from the texts, as one cannot be sure that these accounts do not relate to work done in other capacities, for example as vizier (*sndm-ib; inti* (120)) or *mdh qd nzwt m prwy (nhbw* (90)). What is clear is only that such experience could lead to the tenure of the office of overseer of works. Consequently, the office of builders may have been a part of

1 cf. list in Helck, *Verwaltung*, Register, 25.

Chapter 5 - The Overseers of Works

one of the other state departments, such as the treasury, which can be imagined as controlling the finances of such projects.

The wide range of functions covered by the overseer of works may have been even wider in the fourth dynasty. As noted, this title along with that of **t3yty z3b t3ty** has the longest history of all those under consideration in this study. It is only speculation, but the fifth dynasty functions embodied in the titles **imy-r hwt wrt**, **imy-r zš 'nzw**, **imy-r šnwty** and **imy-r prwy-hd** may have been divided to some unknown extent between the vizier and overseer of works in the fourth. 'Royal works' may then have included also scribal, legal and financial aspects, the increasing burden of which lead to the establishment of new offices in the fifth dynasty.

In conclusion, a translation of **imy-r k3t nbt (nt) nzw** that best describes its activities may be 'Overseer of Royal Works and Workforces', with the various elements removed to translate the less common forms.

6 The Overseers of the Granaries

General

The titles **imy-r šnwt** and **imy-r šnwty** are by far the most common Old Kingdom representations of the office of 'overseer' in the administration of the granaries. However, there are found several apparently related forms: **imy-r šnwt nbt nt nzwt**, **imy-r šnwwt nzwt**, **imy-r šnwt nzwt**, **imy-r šnwt nt hnw**, **imy-r šnwt swt htpw df3w**, **imy-r šnwt nbt**, and **imy-r šnwty nt htpw ntr**. In contrast with the variants of **imy-r k3t nbt (nt) nzwt**, there appears to be only one example of each. Table 20 contains all known holders of this group of titles in the Old Kingdom, both memphite and provincial.

Four instances of such granary titles are not included in this list. In the tomb of **pth-htp II** two men with the title of **imy-r šnwt**, **k3i-hp** and **hp**, are depicted among his dependents.¹ These two men are the only holders of any of the titles discussed in this work who appear as dependents in tomb scenes. They do not form part of table 20 since we cannot be sure that they are not just overseers of the granary of the estate of **pth-htp II**; this question of the number of contexts in which this title could be used is an important one, and will be discussed further below.

The other two examples both come from representations in pyramid temples; as in each case the name of the owner is lost, the same officials may be already included elsewhere and are best omitted. The earlier is shown on a block reused in the Pyramid Complex of

1 The former appears twice on the south wall (Paget-Pirie, **Ptah-hetep**, pl. XXXI, and perhaps also with the title **hry-tp šnwt** on pl. XXXIV), and the latter once on the west wall (*loc. cit.*). In the tomb of **pth-htp I** (49) a certain **k3i-hp** who occurs with the remains of a granary title could possibly be the former official (Murray, **Saqqara Mastabas I**, pl. XIV (3)). It is always possible that **hp** is an abbreviation for **k3i-hp**.

Table 20

List of Overseers of the Granaries

A. Memphite

1. *imy-r šnwt*

Early-middle fifth dynasty		' <i>nh-m-r</i> '	(28)
		<i>k3i-m-snw</i>	(144)
	<i>iffi</i>	(10)	
	<i>wr-k3-ptḥ</i>	(41)	Early-middle sixth dynasty
	<i>shṭpw</i>	(122)	
		<i>imbi</i>	(11)
Later fifth dynasty			
	<i>irw-k3-ptḥ</i>	(12)	

2. *imy-r šnwtj*

Middle fifth dynasty		End fifth-early sixth dynasty		
	<i>sšmw</i>	(127)	* <i>hnmw-nti</i>	(113)
	* <i>ph-n-wi-k3i</i>	(45)	* <i>k3i-gmni; mmi</i>	(151)
	<i>ny-k3-r'</i>	(80)		
			Teti/early sixth dynasty	
Djedkare			* <i>nfr-sšm-r'; šši</i>	(88)
	<i>r'-špss</i>	(95)	* <i>mrrw-k3i; mri</i>	(68)
	* <i>ptḥ-ḥtp</i>	(48)	<i>k3i-ḥr-ptḥ; ftk-t3</i>	(150)
	* <i>ptḥ-ḥtp I</i>	(49)		
	* <i>sndm-ib; inti</i>	(120)	Early Pepy I	
			* <i>hnty-k3i; ihḥi</i>	(109)
Djedkare-Wenis			* <i>mḥw</i>	(69)
	<i>shṭpw</i>	(122)	* <i>ptḥ-ḥtp</i>	(51)
	<i>šym-'nh-ptḥ</i>	(124)		
			Middle Pepy I-early Pepy II	
Early Wenis			<i>išfi; twtw</i>	(19)
	* <i>3ḥt-ḥtp</i>	(2)	* <i>mrri</i>	(67)
	* <i>3ḥt-ḥtp; ḥmi</i>	(3)	* <i>idw I; nfr</i>	(22)
	* <i>sndm-ib; mḥi</i>	(121)	* <i>'nh-mry-r'</i>	(33)
			Middle Pepy II	
Later Wenis			<i>hnmw-ḥtp</i>	(112)
	* <i>ihy</i>	(15)	* <i>nb-k3w-ḥr; idw</i>	(82)
	<i>ḥzzi</i>	(98)		

Table 20 continued

Later Pepy II		End Old Kingdom and later	
* $\underline{h'}$ -b3w-hnmw; biw	(102)	k3i-ny-nbfwi; hnw	(147)
$\underline{d3}$ -mrw	(163)	ttti	(159)
* tti	(156)	\underline{i} pi-hr-ssnbf	(9)
mn-'nh-ppy; mni	(56)	* ttw	(160)
		gmni-m-h3t; gmni	(154)

3. Other Forms

ph-r-nfr	(46):	imy-r šnwt nbt nt nzwt
3hi	(1):	imy-r šnwt nzwt
iffi	(10):	imy-r šnwt nzwt
ny-k3-r'	(80):	imy-r šnwt nt hnw
'nh-m-'-r'	(28):	imy-r šnwt swt htpw df3w
mrw; tti-snb	(64):	imy-r šnwt nbt

B. Provincial

1. imy-r šnwt

Early-middle sixth dynasty

'nh-wnis Thebes¹

Middle sixth dynasty

ihy Thebes²
ny-'nh-ppy km; sbk-htp Meir³

Early-middle Pepy II

* idi Abydos⁴
ibi Deir el Gebrawi⁵

-
- 1 Saleh, *Three Old-Kingdom Tombs at Thebes*, 12-17.
 - 2 *id.*, *ib.*, 26 ff; for a later dating of both 'nh-wnis and ihy, see Kanawati, *Governmental Reforms*, 132-42.
 - 3 Blackman, *Meir* V, 1-15; date, Baer, *Rank and Title*, 84 (212).
 - 4 A variety of monuments: Baer, *op. cit.*, 61-2 (73a); also Fischer, *AJA* 66 (1962), 65-9; date, see the Prosopography under ihy-hnt (16).
 - 5 Davies, *Deir el Gebrawi* I, *passim*; date, Baer, *op. cit.*, 56 (32).

Table 20 continued

Middle-late Pepy II

* 'nh-ppy hry-ib	Meir ¹
* 'nh-ppy hny-km	Meir ²
<u>d</u> 'w; šm3i	Deir el Gebrawi
<u>d</u> 'w	Deir el Gebrawi ³

2. Other Forms

Early Pepy II

k3i-ḥp; <u>tti</u>	Akhmim: ⁴	imy-r šnwty nt ḥtpw ntr
--------------------	----------------------	-------------------------

Middle-late Pepy II

k3i-ḥp; <u>tti</u> -iqr	Akhmim: ⁵	imy-r šnwty nt ḥtpw ntr
-------------------------	----------------------	-------------------------

* indicates vizier at some point in his career

Amenemhat I at Lisht, and is perhaps of sixth dynasty date,⁶ and the second is in the pyramid temple of Pepy II.⁷

According to Porter and Moss, k3i-'pr of Giza also held this title;⁸ however, the illustration shows that the all-important determinative is damaged,⁹ and given the number of expeditionary and related titles he holds, the title in question could equally be read as the military imy-r šnw(t).¹⁰

This group of granary titles appears at the beginning of the fourth dynasty and is still found in the First Intermediate Period. It continues to be attested in the Middle and New Kingdoms. Important provincial granary titles are virtually restricted to imy-r

1 Blackman, Meir IV, *passim*; date, Baer, *op. cit.*, 70 (133).

2 Blackman, Meir V, 16-56; date, Baer, *op. cit.*, 70 (134).

3 For both d'w 's, Davies, Deir el Gebrawi II, 1-13; date, Baer, *op. cit.*, 157 (592). For the separation of the two see Kanawati, JEA 63 (1977), 59-62.

4 *id.*, Hawawish III, 7-32, including dating.

5 *id.*, *ib.* I, 12-37, including dating.

6 Goedicke, Reused Blocks from the Pyramid of Amenemhat I at Lisht, 81

7 Jéquier, Pepi II II, pl. 75.

8 PM 32, 262-3.

9 Hassan, Giza II, fig. 185.

10 Examples of this title, Fischer, JAOS 81 (1961), 423.

šnwty, found not infrequently from the early or middle sixth dynasty until some point in the First Intermediate Period.

The writing of the word for granary does have some palaeographic interest. These considerations concern two parts of the writing, the phonetic elements and the determinative of the granary itself.

Where the phonetic elements of the word šnwt appear, they are invariably in the form , and feature in the writing consistently from the earliest examples until the later fifth dynasty. On an offering basin of iffi (10) the word šnwt is uniquely written

.¹ The earliest writing to omit the phonetic elements is

that in the tomb of pth-htp (48).² Writings both with and without the phonetic elements are found in the same tomb in the later fifth dynasty,³ but in the sixth dynasty the writing without phonetic elements is the rule.⁴

The central lines are the most important palaeographic feature of the determinative of the word šnwt(y). In nearly all fifth dynasty examples these lines reach from the bottom of the granary to at least the middle, and in many cases almost to the top



.⁵ Two of these lines are the rule. Many examples from the second half of the sixth dynasty have short lines within the sign, often not touching the bottom of the granary .⁶

The size of the determinative is generally smaller and squatter in the sixth than the fifth dynasty (against),⁷ although there are exceptions. This may be due to the space available for the signs, as the configuration is found more often in the later period. Examples from the reign of Pepy I to early Pepy II show some increase in the height of the sign, causing it to

1 Mariette, *Mastabas*, 101, now Cairo, CG 1359.

2 Murray, *Saqqara Mastabas I*, pl. IV.

3 Typical examples: 3ht-htp (2) (Davies, *Ptahhetep and Akhet-hetep II*, pl. XIV, XXIX) and k3i-m-snw (144) (Firth-Gunn, *Teti Pyramid Cemeteries II*, pl. 62.

4 Two exceptions in the first half of the dynasty are nfr-sšm-r' (88) (Capart, *Une rue de tombeaux à Saqqarah*, pl. XI), and 'nh-mry-r' (33) (Lauer, *Saqqara*, XVIII).

5 For example, that of ph-n-wi-k3i (45), LD II, 48.

6 For examples, see Strudwick, *GM 56* (1982), 94 n. 9.

7 Compare the examples of r'-špss (95) (LD II, 63) with those of nb-k3w-ḥr (82) (Hassan, *Saqqara I*, fig. 24).

appear narrower and taller.¹ Some from the reign of Pepy II show a rounded lower edge with a triangular-shaped internal mark .2

The granary determinative is not accompanied by the house sign until the end of the fifth or early sixth dynasties, and the latter sign is never particularly common.³

The principal palaeographic conclusions are therefore that the use of phonetic spelling is generally an indication of fifth dynasty date; the larger the sign and the longer the internal vertical lines, the more likely is a date in the fifth dynasty; two short internal lines not touching the outline of the sign are typical of the second half of the sixth dynasty (these may have come to indicate ears of grain); and the granary sign is accompanied by the house determinative only in the sixth dynasty.

The Titularies of the Non-Viziers

A. *imy-r šnwt*

All holders of the title *imy-r šnwt* belong to the fifth dynasty with the exception of *imbi* (11), who dates to the middle sixth or later. None are viziers.

1. Granary Titles

This category of title consists mainly of those containing the word *šnwt(y)*, the most important of which are indicated in table 21, along with other title groups. Principal among these is *hry-tp šnwt*; the others are concerned with scribal functions within the granary organisation. The frequency of the former title suggests that it might have been the rank immediately below that of *imy-r šnwt*; it is the most common non-scribal title apart from that of overseer.

Given that the granaries were above all concerned with food supply, we may speculate that titles concerned with the latter were related to the office of the *imy-r šnwt*. Such titles as *imy-r swt ḥtpw df3w* (*shtpw* and '*nḥ-m-r*'), *imy-r bh't (nbt) nt nzwt* (*k3i-m-snw*), *imy-r i'-r nzwt* and *zš sḥt ḥtp-nzwt* (both '*nḥ-m-r*') perhaps fall into this category. These titles are concentrated on three officials; that they were more important than the other four *imy-r šnwt* can to some extent be judged from the more elaborate nature of their tombs. Consequently, these titles are to be associated with the work of the *imy-r šnwt*, but are of a more privileged nature

1 *išfi* (19) (Capart, *op. cit.*, pl. LXXIII) and *mrii* (67) (Hasan, *Saqqara III*, fig. 17b).

2 *hnmw-htp* (112) (Jéquier, *Pepi II III*, fig. 63), *ḥ'-b3w-hnmw* (102) (*id.*, *ib.*, pl. 52).

3 *ḥzzi* (98) (Cairo, *CG 1413*), and *išfi* (19) and '*nḥ-mry-r*' (33) as above.

than most of the others included in this table.

2. Scribal Titles

Apart from the scribal titles associated with the granary itself held by *irw-k3-ptḥ* and '*nḥ-m-'-r*', there are two examples of *hrp zš* ('*nḥ-m-'-r*' and *imbi*), one of *shd zš* (*irw-k3-ptḥ*), and one of *zš nzwt* ('*nḥ-m-'-r*') held by *imy-r šnwt*. '*nḥ-m-'-r*' and *irw-k3-ptḥ* were evidently men with much scribal experience both within and without the granaries. Otherwise, such titles do not seem to have been a consistent element in the titularies of *imy-r šnwt*.

3. Legal Titles

Legal titles are held only by '*nḥ-m-'-r*', *ḥm-nṯr m3't* and *nst ḥntt*, the latter of which would presumably have been preceded by another legal title (see above page 181). This reinforces the suggestion made above that he was of a slightly different status to the others; the presence of legal titles is perhaps not unexpected because of his scribal ones. Otherwise these titles are not a feature of the titulary of an *imy-r šnwt*.

Table 21

Principal Titles of holders of *imy-r šnwt*

	1	2	3	4	5	6	7	8	9	10	11	12
<i>iffi</i> (10)						0	0			0	X	X
<i>wr-k3-ptḥ</i> (41)						0	0	X		0		
<i>shtpw</i> (122)					X	0	0			1	X	
<i>irw-k3-ptḥ</i> (12)	X	X	X	X		1	0			0		X
' <i>nḥ-m-'-r</i> ' (28)	X		X		X	3	2	X		0		X
<i>k3i-m-snw</i> (144)	X				X	0	0	X		0	X	
<i>imbi</i> (11)	X					2	0		X	0		

Key to Title Columns

1	<i>hry-tp šnwt</i>	2	<i>imy-r zš šnwt</i>
3	<i>zš 'nzwt šnwt</i>	4	<i>zš hryt-' šnwt</i>
5	Titles concerned with food supply		
6	Number of scribal titles	7	Number of legal titles
8	<i>rh nzwt</i>	9	<i>hry-tp nzwt</i>
10	Number of other high offices		
11	Royal institution titles	12	Religious titles

4. Titles associated with the Organisation of Labour

Only the titles **imy-r ḥmwt** and **imy-r ḥmwt ḥkr nzwt** are found, both in the titulary of **iffi**. Such occurrences may perhaps be explained by the existence of his titles **ḥm-ntr pth** and **ḥm-ntr zkr**. These are commonly found elsewhere with holders of the title **wr ḥrp ḥmwt**, which office was very frequently connected with craftsmen in the Old Kingdom. The element **ḥkr nzwt** provides the only link with the treasury among these officials (the possible significance of this element is discussed in the next chapter).

5. Honorific Titles

Three examples of the title **rh nzwt** and one of **hry-tp nzwt** are found among the holders of **imy-r šnwt**. The occurrence of **hry-tp nzwt** is in the titulary of **imbi**, the only sixth dynasty holder of **imy-r šnwt**, in which period **hry-tp nzwt** was a more common title than in the fifth dynasty. Thus these men were all of one of the lower ranks in the bureaucracy, on a par with many of the overseers of works and lower than the scribal and legal officials. However, the associations of 'nh-m'-r' with legal and scribal titles as noted above did not qualify him for the rank of **hry-tp nzwt**; it would seem that the rank of the overseer of the granary was restricted to that of **rh nzwt**.

6. Other High Administrative Titles

Only **shtpw** advanced to a high office beyond that of **imy-r šnwt**, and that was to (presumably) the next stage in the granary, **imy-r šnwtj**. Like low-ranking overseers of works, the careers of the **imy-r šnwt** seem to have remained very much in the one department, having limited opportunities for rising to higher rank or office.

7. Religious Titles

The most important such titles are those of **iffi** noted above in section 4, that is, positions in the hierarchy of the memphite priesthoods of Ptah and Zokar, belong in this category. A large number of religious titles was usually the mark of men of higher rank than that of **imy-r šnwt**.

8. Titles related to Royal Institutions

We have seen that lower ranking holders of other offices bore more royal institutional titles than their more senior colleagues. The holders of **imy-r šnwt**, who were not of the highest rank, held a number of such titles:

iffi (10)

ḥm-ntr r' m nḥn-r'
w'b w'b-swt-wsr-k3f

shtpw (122)

ḥm-ntr nfr-ir-k3-r'
ḥm-ntr r' m st-ib-r'
w'b ḥ'-b3-s3ḥw-r'

k3i-m-snw (144)

hm-ntr nfr-ir-k3-r'
 hm-ntr mn-swt-ny-wsr-r'
 hm-ntr r' m st-ib-r'
 hm-ntr r' hwthr m st-ib-r'
 /// b3-nfr-ir-k3-r'
 w'b mn-swt-ny-wsr-r'
 w'b s3hw-r'

These constitute about half of the holders of **imy-r šnwt**. A very consistent feature is that each man held the combination of **hm-ntr r'** in a sun-temple and **w'b** of a royal pyramid (at least). To these **k3i-m-snw** added some royal priesthoods. This similarity does not imply that it was a special feature of the titularies of **imy-r šnwt**, but rather that these officials were of a similar standing with the king. **imbi**, of the sixth dynasty, did not hold any such titles, as one might expect, since it would seem that from the end of the fifth dynasty such offices were reserved for officials of higher rank. This confirms the similar impression gained for the holders of **imy-r hwt wrt** and **imy-r k3t (nt) nzwt**.

B. imy-r šnwt

Of the thirty-seven memphite holders of **imy-r šnwt** during the Old Kingdom, twenty-two were viziers, who will be discussed separately.

1. Granary Titles

As will be apparent from columns 1-3 of table 22, among the **imy-r šnwt** only **ny-k3-r'** held any titles connected with the lesser offices in the granary, apart from the title of **imy-r šnwt** held by **štpw**. The granary titles of **ny-k3-r'** closely parallel those noted among the holders of **imy-r šnwt**, particularly in the titulary of **irw-k3-ptḥ** (12), suggesting that he probably followed a similar career. His tenure of the title **imy-r šnwt nt hnw** may thus indicate that that title was not dissimilar in function to **imy-r šnwt**. There is only a very limited number of the titles connected with food supply mentioned on page 256 above: **štpw** was **imy-r swt ḥtpw df3w**, and **išfi** held both **imy-r i'-r nzwt** and **imy-r šḥt ḥtpw**.

The other holders of **imy-r šnwt** have titularies that are either unclear as to their career patterns, or show evidence of involvement in labour organisation, scribal or legal matters. The evidence, or lack of it, points to the possibility that, as suggested above for certain other officials (for example, **ty** (157) in relation to the title of overseer of works), men were chosen for this position as much for their abilities as administrators as for their past experience relative to the granaries. This would seem particularly true for the period after the middle of the fifth dynasty.

Table 22

Principal Titles of non-viziers who held **imy-r šnwt**

	1	2	3	4	5	6	7	8	9	10	11	12	13	14	15
sšmw (127)					0	6	0					1	X		X
ny-k3-r' (80)	X	X	X		0	2	1				X	1			X
r'-špss (95)					0	0	3	1		X		2	X		
shtpw (122)				X	0	0	0					1			X
šhm-'nh-ptḥ (124)					7	0	3			X		2	X	X	
hzzī (98)					0	1	2			X		2			
k3i-hr-ptḥ (150)					4	0	2					0			X
išfi (19)				X	0	0	0		W			1	X	X	
hrmw-ḥtp (112)					0	0	0	X	X			1			
d3-mrw (163)					0	0	0	X	W			0			
mn-'nh-ppy (56)					0	0	0		W			0		X	
k3i-ny-nbfwi (147)					0	0	0			X		0			
ttti (159)					0	0	3		X			0			
īpi-hr-ssnbf (9)					0	2	0					X	0		X
gmni-m-ḥ3t (154)					0	0	0	X				X	0		X

Key to Title Columns

- | | |
|---|------------------------------------|
| 1 hry-tp šnwt | 2 imy-r zš md3t nt šnwt |
| 3 shd zš šnwt | |
| 4 Titles associated with food supply | |
| 5 Number of other scribal titles | 6 Number of legal titles |
| 7 Number of labour titles | 8 iry p't and ḥ3ty-' |
| 9 W = smr w'ty , B = sd3wty bity , X = both | |
| 10 hry-tp nzwt | 11 rh nzwt |
| 12 Number of other high offices | 13 Titles with wd(t)-mdw |
| 14 Religious titles | 15 Royal institution titles |

2. Scribal and Legal Titles

The following officials have several scribal titles: **ny-k3-r'** (principally in the granary), **r'-špss**, **šhm-'nh-ptḥ**, **k3i-hr-ptḥ**, **hzzī** and **ttti**, of whom only **k3i-hr-ptḥ** is certainly of the sixth dynasty. All but the first and last of these officials also had several legal titles. However, it is clear that neither type of title was a consistent and distinctive feature of the titular of an **imy-r šnwt**.

3. Titles Associated with the Organisation of Labour

In the instances of **sšmw** and **hzzī** such titles are presumably more closely associated to their tenure of the office of **imy-r k3t nbt (nt) nzwt** than anything else. As regards **sšmw**, **imy-r k3t nbt (nt) nzwt** would seem to be the more logical promotion on the basis of

his titularly than **imy-r šnwty**, and this latter title may have been a subsequent addition as a result of his excellence as an administrator. As such it may have been intended to use his demonstrated ability at organising workforces for the benefit of the granary organisation, or perhaps for supplying workmen (cf. page 267).

4. Honorific Titles

In the fifth dynasty the holders of **imy-r šnwty** were principally **hry-tp nzwt**, but in the sixth there is a tendency for the rank to have risen at least to **smr w'ty** and **sd3wty bity**. This is in accord with the general rise in rank in this period. Both officials certainly active in the reign of Pepy II (**hnmw-htp** and **d3-mrw**) reached the ranks of **iry p't** and **h3ty-'**.

Only one of the earlier holders of the title, **ny-k3-r'**, held the title of **rh nzwt**. **rh nzwt** appears again at the end of the Old Kingdom and First Intermediate Period, suggesting a further change in the ranking of holders of **imy-r šnwty**, at which time it is again found together with **hry-tp nzwt**. The honorific titles of these officials serve to differentiate them from the **imy-r šnwt**.

5. Other Important Administrative Titles

	1	2	3	4
sšmw (127)			X	
r'-špss (95)		X	X	
shm-'nh-ptḥ (124)	X	X		
hzzī (98)			X	X
išfi (19)				X
hnmw-htp (112)				X

Key to columns:

- | | |
|----------------------------------|--------------------------|
| 1 imy-r hwt wrt | 2 imy-r zš ' nzwt |
| 3 imy-r k3t nbt (nt) nzwt | 4 imy-r prwy-hd |

The distribution of these is given above. Their appearance is usually linked to the career structures indicated by the titularies of the holders. **sšmw** was very much concerned with the organisation of labour, **r'-špss** and **shm-'nh-ptḥ** scribal/legal officials, but the career patterns of **hzzī**, **išfi** and **hnmw-htp** are not totally clear. The latter three are almost the first officials discussed so far to have held **imy-r prwy-hd**, and this shows a link with **imy-r šnwty** that will be seen to be common, particularly with viziers.

The majority of instances of more than one important administrative title being held by a non-vizier again occur in the fifth dynasty. The majority of the sixth dynasty and later holders of **imy-r šnwty** did not hold any additional high offices, which must be as a result of a deliberate decision on the part of the king. It is likely that the accumulation of high titles is due more to the

general favour and ability of an official than to any specific links between the titles with the possible exception of **imy-r prwy-hd**, further associations with which department will be seen in the course of this and the next chapter.

6. Religious Titles

There are no consistent patterns of tenure of any religious titles, suggesting that there was no particular deity associated with the granary. The two occurrences of **hry-hb** are both of sixth dynasty date (**išfi** and **mn-'nh-ppy**), when this title was often found with individuals of the rank of **smr w'ty**.

7. Titles connected with Royal Institutions

Such titles as these are not infrequent, and are given below:

sšmw (127)	hm-ntr r' m st-ib-r'
ny-k3-r' (80)	hm-ntr hr st-ib-t3wy
	hm-ntr r' m šzp-ib-r'
	hm-ntr s3hw-r'
	hm-ntr ny-wsr-r'
	hm-ntr r' m st-ib-r'
šhtpw (122)	hm-ntr nfr-ir-k3-r'
	hm-ntr r' m st-ib-r'
	w'b h'-b3-s3hw-r'
k3i-hr-ptḥ (150)	imy-r niwwt m3wt nt nfr-dd-k3-r'
	šhd w'b 3ht-hwfw
ipi-hr-ssnbf (9)	mty n z3 dd-swt-tti
gmni-m-h3t (154)	mty n z3 dd-swt-tti
	mty n z3 w3d-swt-mry-k3-r'

Usually they are found in the fifth dynasty with officials who held one or no further high offices. These examples illustrate the changes in the ranking of royal priesthoods between the fifth dynasty and the sixth and later: the sixth dynasty titles were almost certainly more elevated than those found in the fifth, and were certainly more prominently placed in inscriptions.¹

8. Other Titles

Titles incorporating the elements **w d(t)-mdw** have been noted above as a common element in the titularies of important officials. This is also true for the office of **imy-r šnwty**, as in each occurrence in column 13 of table 22, the individual concerned is one who held at least one further high administrative title.

1 cf. Baer, **Rank and Title**, 264 ff.

C. Conclusions and Discussion of Variants

The titularies of holders of *imy-r šnwt* and *imy-r šnwty* were very different, the titles of the former showing much closer associations with the granaries than the latter, who appear to have followed no particular career pattern. The holders of *imy-r šnwty* were certainly the more important people, and the one title cannot be regarded as a simple graphic variant of the other.

There are several extensions to the title of 'overseer of the granary' in table 20. It may be possible to relate these to either of the above titles. That of *ph-r-nfr* (46) (*imy-r šnwt nbt nt nzw*) is clearly parallel in form to the title of *imy-r k3t nbt nt nzw*, which he also held (together with the other important title of *imy-r pr-hd*). Given his importance in the early fourth dynasty, this title should be placed on a level with the later *imy-r šnwty*, particularly in view of the other high titles he held. The same is probably true for the title *imy-r šnwwt nzw* of 3hi (1), whose other titles were *imy-r k3t nbt nzw* and *imy-r prwy-hd*.

imy-r šnwt nzw held by iffi (10) is not accompanied by any other important state administrative titles. It is likely that this title represents a promotion from or a special version of the title *imy-r šnwt* attested elsewhere in the tomb. It is important to note that the three officials named above all antedate the earliest appearance of *imy-r šnwty*, and they may have exercised the same functions. Thus iffi could have been an official who rose from one rank in the granary to a higher one, in the manner of shtpw (122) 's promotion from *imy-r šnwt* to *imy-r šnwty*.

The remaining forms were held by men who were also either *imy-r šnwt* or *imy-r šnwty*. The career structure of *ny-k3-r*' (80) is notable among the holders of *imy-r šnwty* for its number of granary titles, and it has been suggested that the career pattern for his title *imy-r šnwt nt hnw* was very much like that of *imy-r šnwt*. *imy-r šnwt swt htpw df3w* is found in the titulary of 'nh-m-'-r' (28), who held another title related to such offerings. It may have been a mark of favour granted to him over and above his title of *imy-r šnwt*.

Given the frequency of the title *imy-r šnwty* in the sixth dynasty it is unlikely that the title *imy-r šnwt nbt* of mrw (64) was exactly equivalent to it. He held no other important state offices, but had a number of courtly and pyramid titles which were important in the early sixth dynasty (for example, *imy-r sqbbwy pr-3* and *shd hm-ntr dd-swt-tti*). His rank is more elevated than that of imbi (11), the only sixth dynasty holder of *imy-r šnwt*, suggesting that the two titles were not mere variants of one another. This title may again have been granted as a mark of special favour, or as a result of a special commission, with duties (if any) falling somewhere between those of *imy-r šnwt* and *imy-r šnwty*.

The Viziers

An examination of the titularies of viziers indicates the presence of **imy-r šnwty** as their only important administrative title concerned with the granaries; this was held by twenty-two such officials. It is therefore evident that viziers were not necessarily chosen from granary officials, and is further evidence that tenure of **imy-r šnwty** was not necessarily related to any other knowledge of the administration of the granaries.

There is insufficient evidence to determine the number of viziers who held the office of **imy-r šnwty** before promotion to their highest office. **r'-šps** (95) certainly was **imy-r šnwty** before his vizierate, but it is not known whether he then continued to hold this title.

To anticipate briefly some of the conclusions in chapter 8, the concentration of other high administrative titles on viziers holding **imy-r šnwty** is very high, and suggests that this title was indeed of great importance in Old Kingdom administration.

The Administration of the Granaries

A. The Organisation of the Overseers of the Granaries

It is evident that there were times, in the fifth dynasty principally, but also in the sixth, when there were simultaneous holders of the offices of **imy-r šnwt** and **imy-r šnwty**. Furthermore, the number of both vizierial and non-vizierial holders of the latter office suggests that there could have also been two holders of that title at the same time, giving a total of three possible contemporary important granary officials.

From study of the titles **imy-r zš ' nzw** and **imy-r k3t nbt (nt) nzw** we have seen that at certain times these offices were similarly divided, with the vizier carrying the overall responsibility, and the non-vizier performing the ordinary duties. In the case of **imy-r zš ' nzw** the non-vizierial holder disappeared at the end of the fifth dynasty, while in the case of **imy-r k3t nbt (nt) nzw**, it was in the middle of the sixth.

imy-r šnwty differs slightly from these. There seem to have been five or six non-viziers who held this title in the fifth dynasty together with eight or nine viziers. For the first part of the sixth dynasty there are at the most two non-viziers as opposed to about eight viziers.

The reign of Pepy II seems to have seen seven **imy-r šnwty**, three of whom were not viziers. This would seem to be a minimum number for the period of ninety years ascribed to Pepy in Egyptian tradition, and this suggests very little overlapping between them.

There were clearly more non-viziers holding **imy-r šnwty** than in the case of either **imy-r zš ' nzw** or **imy-r k3t nbt (nt) nzw** in the sixth dynasty. However, the fact that the majority of holders were viziers suggests that the administrative change noted for **imy-r zš ' nzw** and **imy-r k3t nbt (nt) nzw**, by which the number of non-viziers at the head of the departments was reduced, also had its effect on the granary. It must have been a very important

institution for the vizier to hold the principal office for most of the time.

Four or five non-viziers belong to the period from the end of the sixth dynasty until at least the tenth. There is more memphite evidence for this title at this time than for any of the others under consideration. Only two viziers with the title date to this period, **tti** (156) and **ttw** (160), while the non-viziers of this time held only the one high office.

From the spread of the material it is clear that the existence of officials to run the granary was extremely important in the Old Kingdom, as these titles seem to have survived while others fell into disuse. This must surely be associated with the importance to Egypt of the management of the grain supply necessary for a stable society.

What granaries are to be understood in the titles **imy-r šnwt** and **imy-r šnwty**? The most plausible explanation for the dual form of **imy-r šnwty** is that it implied control of the granaries of the whole land and not two particular ones.¹ Support for such a view may be derived from the fact that holders of **imy-r šnwty** did not usually hold any other granary titles, suggesting their overall control without necessarily dealing with the minutiae of granary affairs.

On this basis, we might expect to find **imy-r šnwt** in charge of individual granaries. Unfortunately, next to nothing is known about the location and number of the granaries. It is additionally possible that some **imy-r šnwt** may have belonged to granaries of private estates (page 251). However, the tombs of some **imy-r šnwt** (**štpw** (122), **'nh-m--r'** (28) and **k3i-m-snw** (144)) are quite imposing, and it would be difficult to imagine them working simply on a private estate. On balance then it is best to take the **imy-r šnwt** who owned tombs as being associated with granaries related to the central administration, and leave those in tomb reliefs as pertaining only to private estates.

The very limited number of holders of the title **imy-r šnwt** is a problem in that they can hardly have been numerous enough for each to have controlled a single granary. Either the principal state granary only is meant, or else each **imy-r šnwt** may have been responsible for a number of granaries; it is very likely that their work was then coordinated by the **imy-r šnwty**.

The titles **imy-r šnwt nt hnw** of **ny-k3-r'** (80) and **imy-r šnwt swt htpw df3w** of **'nh-m--r'** (28) make reference to specific granaries. Only one of these, the 'granary of the residence' is attested again (see table 23, nos. 6, 8); it could have been an establishment specifically for the royal residence or even a name for one of the state granaries (cf. the '(two) treasuries of the residence' in the next chapter). It cannot be discovered whether the other occurrences of **imy-r šnwt** refer to these or different granaries, nor can it be discovered whether such titles were created for these individuals alone; there seems to have been a marked reluctance on the

1 The dual form was often used in this manner, Helck, **Beamten-titel**, 64.

part of the Egyptian of the Old Kingdom to specify the particular institutions to which he belonged. We only need to compare the above titles with a selection of those extant in the Middle and New Kingdoms (especially the latter) to see the difference.¹ We will see below that the number of known holders of granary titles is much lower than must have been required to run the institution.

The most plausible associations of the *imy-r šnwt* must have been with the state granaries, and were then doubtless responsible for the collection and distribution of grain within the land. The small number of such titles however suggests that, unlike *imy-r hwt wrt*, there was not a continuous sequence of holders of the position after the later fifth dynasty.

Thus the principal office in granary administration was *imy-r šnwt*, whether held by a vizier or non-vizier. The granaries for which this official was responsible were presumably run on a local basis by officials of whom little or no trace has survived.

The existence of provincial holders of this title may partly account for the differences noted between the fifth and sixth dynasty. One of these men, 'nh-ppy hny-km of Meir, seems also to have held the title *imy-r šnwt*. This is the only such provincial example, and one is tempted to regard it as a compression (for spatial reasons ?) of *imy-r šnwt*; this argument may be supported by the occurrence (again unique for the provinces) of *imy-r pr-hd* in the same tomb, which was perhaps written for *imy-r prwy-hd* (below page 292).

Holders of *imy-r šnwt* make up the largest group of provincial holders of any of the six titles forming the subject of this work, and it is therefore logical to conclude that this title was one of the most essential to the government of the provinces apart from the vizierate and the office of overseer of Upper Egypt. It is perhaps likely that the development of provincial administration in the sixth dynasty and the appearance therein of holders of *imy-r šnwt* may explain the reduction in the number of memphite holders of this title. The frequency of its occurrences in the provinces, particularly in the same nomes, makes it unlikely that its holders exercised the same functions in Memphis before moving to their new locations.² With this number of concurrent holders of *imy-r šnwt*, it is clear that they cannot all have had the same overall control of the granary organisation, but rather in many cases their control was more localised, and they were fulfilling a role more like that of *imy-r šnwt* in the sixth dynasty.

The range of locations of these provincial *imy-r šnwt* is rather restricted - Thebes, Abydos, Meir, Deir el Gebrawi and Akhmim. There is no obvious reason for the choice of these particular provinces, such as that they were centred on the most productive land in Upper Egypt,³ or that they were distributed evenly through this area. Unless there was some strategic significance that is not immediately apparent, the appearance of members of the same

1 cf. Helck, *Verwaltung*, Register, 24-5.

2 Martin-Pardey, *Provinzialverwaltung*, 137.

3 Compare the data in Kanawati, *Governmental Reforms*, 6-10.

families suggests that it may have been as much to do with royal advancement of particular favoured groups as anything else. The exact datings of these officials are not relevant here; what is important is that during the second half of the sixth dynasty they compensate for the low number of equivalent officials in the memphite area, implying that previously part of the functions of the memphite holders of this title was to manage the provincial granaries. It is likely that there were often at least two simultaneous holders of this title in different nomes, presumably each responsible for the management of the granaries in the surrounding areas.¹ Thus the effect of decentralisation of administrative offices is as evident here as it was with *imy-r zš 'nzw*t and *imy-r k3t nbt (nt) nzw*t.

B. Other Aspects

Old Kingdom evidence for the activities of the administration of the granary is very slight, due to the lack of preservation of documents and the bias of the remaining material towards the funerary aspect. That the state granaries dealt with the collection and distribution of grain can only be clearly attested from a variety of later sources.² Also, an inscription dated to the reign of Senwosret I refers to the bread and beer of the workmen on a quarrying expedition as coming from the 'granary of the lord' (*šnwt n nb*), clearly meaning the royal granary.³ In view of the importance of such expeditions in the Old Kingdom, we can envisage the granary performing the same function in that period.

Scenes relating to the cultivation and storage of grain are common in private tombs, although models of granaries are not really an Old Kingdom feature.⁴ Buildings which are presumably small granaries are frequently shown from early times, and more often than not bear no descriptive tag. However the granaries shown in the tomb of *ty* (157) are termed *šnwt ntt m pr-šn' hry wd'w n hrt 3bd*, 'the granaries which are in the storeroom which are concerned with the supply (?) of the requirements of the month',⁵

- 1 For discussion of the possible datings, juxtapositions and functions of these officials, see Kanawati, **Governmental Reforms** 74 (c), 97.
- 2 Principally New Kingdom material, for example, that presented by Gardiner in *JEA* 27 (1941), 19-73, and P. Geneva D191, which refers to grain received into the granary of Amun (Černý, *LRL*, 57-60 (37) and translation, Wentz, *LRL*, 71-4 (37)).
- 3 Inscription of *imny* in the Wadi Hammamat, Goyon, **Nouvelles inscriptions rupestres du Wadi Hammamat**, no. 61, line 19; comments by Mueller, *JNES* 34 (1975), 261.
- 4 Perhaps the earliest example is British Museum 21804, probably of sixth dynasty date (Breasted, **Egyptian Servant Statues**, 12-13, pl. 9 c; cf. Vandier, **Manuel VI**, 223). For a discussion of the collection of grain, see Vandier, *op. cit.*, 183-208.
- 5 Epron-Wild, **Tombeau de Ti I**, pl. LXX.

and those in the tomb of $\check{y} \check{snwt} nt dbhw prt-hrw nt \check{y}$, 'the granaries for the requirements of invocation offerings of \check{y} '.¹ The main problem regarding these and all granaries shown in tomb reliefs is whether they belonged to the estates of the deceased or to the state. We have assumed on page 265 that the $imy-r \check{snwt}$ who owned tombs were employed in the state granaries, and those shown on tomb walls in the private funerary estates. The frequency of depictions of grain-related activities in tomb scenes must in all probability refer to the deceased's estates, doubtless intending to show the perpetuation of his own private income and funerary offerings.² It will be seen later that granaries and treasuries were in many ways related, but the latter hardly ever appear in tomb decoration, which is a further argument for the restriction of these depictions to the tomb owner's estates.³







While the existence of a granary can be documented in the residence and in private estates, the location of the principal state ones remains unknown. It is possible that there were local granaries responsible to the central office, as this would surely be the most efficient means of ensuring the collection and distribution of the grain. Institutions of all sorts may have had their own granaries, especially those that owned land which would produce grain for them, but, apart from the residence, information is very restricted.

The Abusir Papyri attest the movement of grain: one document refers to types of grain brought from the granary, and this is thought by Posener-Kriéger to have come from a state granary.⁴ Without doubt, this would have been put into a granary inside the temple, although this may have been within the $pr-\check{sn}'$.⁵



The same group of texts provides some information about the existence of other granaries. An institution called  is attested,⁶ and there are several examples of the word \check{snwt} or the sign for granary, the context of which has been lost.⁷ Posener-

-
- 1 Jéquier, *Tombeaux*, fig. 69. A very similar example may be found in the tomb of $hnmw; hnmw-nti$ (111), *id.*, ASAE 35 (1935), 145.
 - 2 Advanced on different grounds by Kaplony, *Studien zum Grab des Methethi*, 88. There is also an explicit reference to the $\check{snwt} nt pr-dt$ (Moussa-Altenmüller, *Nianchchnum*, Taf. 23).
 - 3 The Gebelein Papyri may shed more light on the running of such an estate granary; for example, a $sd\check{w}ty \check{snwt}$ is found therein - Posener-Kriéger, *RdE* 27 (1975), 219.
 - 4 *HPBM*, pl. XLI c2; Posener-Kriéger, *ArchAb* I, 329, II, 628; also Kaplony, *Or* 41 (1972), 72.
 - 5 An analogy from the tomb of ty suggests this - the $\check{snwt} ntt m pr-\check{sn}'$ are shown (see above). Recording and movement of grain can take place in the presence of officials of both the granary and the $pr-\check{sn}'$ (Moussa-Altenmüller, *loc. cit.*).
 - 6 *HPBM*, pl. LXIII A; Posener-Kriéger, *op. cit.* I, 390 (c).
 - 7 *HPBM*, pl. LXXVI M, LXXIX X, CIII B.

Krieger does not believe these necessarily to have been parts of the mortuary or sun temples of Neferirkare.¹ There are other possible references to the **tnt**-granary, which may perhaps localise it in the memphite area, in the tomb of **ny-'nh-hnmw** and **hnmw-htp**.² Moussa and Altenmüller take the word **tnt** to be related to **tnwt** 'counting'.³ However, the reference in the Abusir Archive might suggest that it was an institution in its own right.⁴ It is refer-

red to in this tomb as the **tnt** of wheat (  ) and the **tnt** of barley (  ). The granary sign is somewhat

different in its internal decoration from that normally found in the word **šnwt**, which argues against it being a simple logographic writing of that word, but rather a determinative.⁵ In a higher register of the same scene a scribe is seen doing accounts who is called **zš tnt it**, where the determinative is not found. Perhaps the verb **tnt** had some connection with reckoning, and the granary

  was a tax collection point.

Other special granaries are attested in relation to funerary and other offerings. The title **imy-r šnwt swt htpw df3w** (perhaps 'overseer of the granary of the offices of food-offerings') is found in the titulary of **'nh-m-'-r'** (28), and we have already seen lines of granaries concerned with funerary offerings in various tombs. In the case of the latter, it is probable that they represent granaries on the deceaseds' estates, but this title of **'nh-m-'-r'** may either refer to state granaries designated for this particular purpose but only appearing in this one title or else be a title created specially for him.

The state granaries certainly played a role in the provision of offerings for the dead in the Old Kingdom. Several funerary inscriptions give, in a formulaic manner, the origin of some of the principal offerings to the deceased. A typical example comes from the tomb of the **imy-r pr-ḥd k3i-pw-r'** (143) at Saqqara:

**htp di nzwt htp di inpw hnty zh ntr rdi n.f prt-ḥrw m hnw
it bdt m šnwti ḥbs m prwy-ḥd mrḥt m izwy ḥt brnt m pr-išd.**

-
- 1 **op. cit.** II, 516-7.
 - 2 Moussa-Altenmüller, **op. cit.**, Abb. 24.
 - 3 **op. cit.**, 127.
 - 4 Agreeing with this view, Meeks, *Année Lexicographique I* (1977), 419 (77.4828).
 - 5 It could also represent the quantity 100, perhaps the capacity of the granary; an example possibly to be interpreted this way is Jéquier, *Tombeaux*, fig. 83 (tomb of **mḥi**). For an example of granaries bearing names of types of grain see the panel of the false door of **nfri**, Cairo, CG 1653.

An offering which the king gives and an offering which Anubis who dwells in the divine booth gives, that there be given to him invocation offerings from the residence, wheat and barley from the two granaries, clothing from the two treasuries, **mrht**-oil from the two chambers and sweet things from the house of **išd**-fruit.¹

Here we have actual examples of what was intended by the phrase **htp di nzw**, 'an offering which the king gives', coming from a state institution.² There are several other similar examples of these formulae which mention granaries, sometimes in the dual,³ sometimes in the singular.⁴ No obvious difference seems to exist between the singular and dual formulae, although two of the latter mention two types of grain (**it** and **bd**) whereas the former mention only **it**. References to the treasury mention almost always just the **prwy-ḥd**. It is possible that **šnwt** is used in the earlier examples and **šnwtj** in the later, but also it can be said that one reference is to a specific granary and the other to the granaries of the whole land.

One further granary is attested, but of a very different sort. In the Pyramid Texts is found: **šzp** (King) **pn st ht m ntt m šnwt nt ntr-'3** - 'This (king) receives a meal from that which is in the granary of the Great God'.⁵ The signs  following **st ht** show

that bread and beer were very much concerns of the granary (compare the provisions mentioned above page 267). Thus mythological granaries took much the same form as those on earth.

Two further references to granaries in Old Kingdom texts may be noted, although they add nothing to the picture gained above. A **hry-tp šnwt ny-k3w-r'** appears in the Abusir Papyri; however his relationship with the temple is unknown, although he may have been working in the storerooms or perhaps linked with the bringing of bricks for repairs to the temple.⁶ The other reference is in the biography of **3ht-htp; ḥmi** (3), where the deceased addresses the officials (**imy-st-**) of several institutions including the granary.⁷ However, the text of his words is lost.

Helck suggests that the organisation of the estate granaries imitated that of the state ones.⁸ Below are listed granary officials who appear in tomb scenes which tell us something about the activities of this section of the administration, whether these officials be working for state or private granaries. In addition

1 Urk. I, 177.8-10.

2 cf. Posener-Kriéger, *op. cit.* I, 263 (c).

3 **s3bw; ibbi** (116), Urk. I, 177.14-6; **ḥzzi** (98), Cairo, CG 1413; **'nh-m-'-r'** (28), unpublished; **ny-k3w-r'**, Cairo, CG 1414.

4 **k3i-m-snw** (144), Urk. I, 175.10-12; **šhm-k3i**, Urk. I, 177.2-4; **tnti**, Urk. I, 164.13-4.

5 Pyr. 1182a.

6 HPBM, pl. LXII (46); Posener-Kriéger, *op. cit.* II, 385-88, 598.

7 Hassan, Saqqara I, fig. 18, pl. XXVII (B).

8 Beamtentitel, 64.

to these, there are a number of granary officials who appear in uninformative contexts, such as acting as offering bearers, good examples of which are the two *imy-r šnwt* discussed on page 251 above.

hry-tp šnwt

- 1 LD Erg., Taf. XIV
Carries a papyrus roll.
- 2 Firth-Gunn, *Teti Pyramid Cemeteries II*, pl. 53 (1).
Presents a papyrus to the deceased (*k3i-gmni* (151)); above is the caption *hsb hnwt*, 'reckoning cargoes (?)'.
- 3 Capart, *Une rue de tombeaux à Saqqarah*, pl. LXXXVII
Writing at the side of a fishing and fowling scene, accompanied by the text *iw.i r dit hq3t r wr*, perhaps 'I shall give a *hq3t* of grain to the great one', meaning the deceased.

zš šnwt

- 1 LD II, 56.
Seated before a small granary with the text *ipt ht in zš šnwt*, 'making accounts by the scribe of the granary'.
- 2 Junker, *Giza XI*, Abb. 80.
Shown as a member of the *d3d3t nt pr-dt*
- 3 LD Erg., Taf. XXI.
Writing before a line of small granaries.
- 4 Simpson, *Sekhem-ankh-ptah*, pl. D, fig. 8.
Is accompanied by a quantity of scribal equipment.
- 5 Curto, *Gli scavi italiani a el-Ghiza*, fig. 35.
Presumably recording agricultural activity.
- 6 Kaplony, *Studien zum Grab des Methethi*, 22 (nr. 2)
Presents a papyrus to the deceased.
- 7 Borchardt, *Ne-user-re*', Abb. 103.
Writing next to a corn-measuring scene.
- 8 LD II, 51.
As 7.

shd zš šnwt

- 1 Capart, *loc. cit.*
Adjacent to *hry-tp šnwt* no. 3, with the text *it hq3t 10 r sh3.f*, perhaps 'ten *hq3t* of grain to satisfy him', presumably meaning the deceased.

nht-hrw n šnwt

- 1 LD II, 103a.
Watches (or supervises ?) the measurement of grain.
- 2 LD II, 62.
Stands behind three scribes who record something to do with grain: *d3d3t n[t] pr-dt hr h3 ///* (the figure 32 and a granary sign are visible) *int m šm'w hwt niwnt.f ///* *m nb zš*, 'The *d3d3t* of the funerary estate who are measuring

grain ... brought from his estates and settlements in Upper Egypt .. all in writing'.

3 Moussa-Altenmüller, *Nianchchnum*, Taf. 23.

Very similar to 1 but the grain is also being recorded.

4 LD II, 71a bis.

Accompanied by a corn-measurer and a scribe of the *d3d3t* with the caption *ipt ht m niwnt.f.*, 'making the accounts' of his settlements'.

The work of all these officials, with the exception of *nht-hrw n šnwt*, was apparently involved with reckoning. It is clear that the office of *hry-tp šnwt* was principally concerned with the administration of the granaries, and one may assume that the same was true for the *imy-r šnwt*, doubtless his immediate superior. The representations described above do not show the *hry-tp šnwt* acting any differently from the holders of the purely scribal offices of *zš šnwt* and *šhd zš šnwt*. The difference was thus presumably in seniority and the degree of responsibility carried. Only the *nht-hrw n šnwt* is shown supervising work with the grain itself - this title should perhaps be translated as 'Foreman of the granary'.¹ It is unfortunate that the context of an example of this title (with the addition of *nt hnw*) in a papyrus has been lost.²

One further group of title-holders which must have been involved with the granaries was the grain measurers (*h3w*), who are shown at work in various tomb scenes, and of whom a number of small figures have survived.³ A number of tomb-owners who held such titles are known.⁴

The range of granary and related titles found in the titularies of tomb owners is shown in table 23. These titles suggest that very many offices specifically mentioning the granary were of a bureaucratic nature and concerned with the keeping of records. Other less specific administrators appear with the titles of *iry-ht*, as well as sealers, men concerned with scribal equipment (*hryt-'*) and also the important connection with the central bureaucracy through the '*nzwt*'. The latter are documents coming from the central administration which would presumably authorise certain actions in the granary. Again the only offices not concerned with the bureaucratic side are those with *nht-hrw*.

For most titles in table 23 it is unsure where they were placed in the hierarchy of the granaries. However, from the monuments of

1 Further comments, Fischer, *Offerings*, 73.

2 Posener-Kriéger, *RdE* 32 (1980), 84. The same papyrus also contains the title *šhd iry-ht n šnwt*.

3 Some tomb scenes: von Bissing, *Die Mastaba des Gem-ni-kai II*, Taf. XII; Simpson, *Sekhem-ankh-ptah*, pl. D, with the text *h3 it in d3d3t*; Moussa-Altenmüller, *Nianchchnum*, Taf. 23. For some models see Breasted, *Egyptian Servant Statues*, 10-12, pl. 9 (a, b).

4 For example *nfrn* (Junker, *Giza VI*, Abb. 76), *rdif* (*id.*, *Giza IX*, Abb. 41) and *nfr* (Cairo, CG 1313).

Table 23

List of Granary Titles in the titularies of Tomb Owners

Title	Number of Holders
1 hry-tp šnwt	6
2 ḥtm šnwt nzwt	1
3 imy-r zš md3t nt šnwt	1
4 imy-r zš šnwt	3
5 nḥt-ḥrw n šnwt	1
6 nḥt-ḥrw n šnwt nt ḥnw	1
7 šhd iry-ḥt n šnwt	2
8 šhd iry-ḥt šnwt nt ḥnw	1
9 šhd zš ' nzwt šnwt	2
10 šhd zš šnwt	3
11 zš ' nzwt šnwt	2
12 zš hryt-' šnwt	1
13 zš šnwt	6
14 zš šnwt ḥwt-'3t	1
15 imy-r zš md3t šnwty	1
16 imy-r zš šnwty	1

References:

- 1 ny-k3-r' (80) - unpublished; irw-k3-ptḥ (12) - LD Text I, 13
'nh-m-'-r' (28) - unpublished
k3i-m-snw (144) - Firth-Gunn, *Teti Pyramid Cemeteries II*, pl. 63 (5)
imbi (11) - Drioton-Lauer, *ASAE* 55 (1958), pl. XX (d)
sndm-[ib] - Martin, *Hetepka*, pl. 24 (33)
- 2 nfr-ḥr-n-ptḥ - Petrie, *Gizeh and Rifeh*, pl. VIIA
- 3 ny-k3-r' (80) - as 1
- 4 irw-k3-ptḥ (12) - as 1
ḥnti - Giza tomb G4311 - unpublished
Name Lost - Cairo, CG 1719
- 5 mry-nzwt - Fischer, *Offerings*, 70, fig. 1
- 6 mry-nzwt - as 5
- 7 itif-ḥ3i - Bakir, *Slavery in Pharaonic Egypt*, pl. I
mry-nzwt - as 5
- 8 mry-nzwt - as 5
- 9 nḥt-k3i - Hassan, *Giza VII*, fig. 20
'nh-m-r' - Curto, *Gli scavi italiani a el-Ghiza*, fig. 34
- 10 ny-k3-r' (80) - James, *Corpus of Hieroglyphic Inscriptions in the Brooklyn Museum I*, pl. XIX (A, B)
nḥt-k3i - as 9; 3ḥt-ḥtp - Hassan, *Giza I*, fig. 134
- 11 irw-k3-ptḥ (12) - as 1
k3i-ḥr-ptḥ - unpublished (son of 'nh-m-'-r' (28))
- 12 irw-k3-ptḥ (12) - LD Text I, 12

continued

Table 23 continued

- 13 'nh-m-'-r' (28) - as 1
 pth-nb-nfrt - Junker, Giza VI, Abb. 91
 hnmw-htp - Mariette, Mastabas, 260
 dr-snd - cf. PM 3², 176
 ssm-nfr - Petrie, op. cit., pl. VIID (top)
 3ht-htp - Hassan, Giza I, fig. 137
- 14 hnmw-htp - Giza tomb G7836 - unpublished
- 15 htpi - Fischer, JNES 18 (1959), 260
- 16 sndm-[ib] - Martin, loc. cit.

the imy-r šnwt irw-k3-ptḥ (12) we obtain the sequence hry-tp šnwt, imy-r zš n šnwt, zš 'nzwṯ šnwt. To the beginning of this we can safely add imy-r šnwt, imy-r šnwt.

Most of the titles in the sequence given above are found only in the titularies of the most important granary officials. As well as being of lower rank and having no rankable granary titles, the less important officials show a different pattern of burial places from the imy-r šnwt. The latter are all buried at Saqqara with the exception of 'nh-m-'-r' (28), while the majority of the less important men have their tombs at Giza. This emphasises that the site of Giza was generally the less important of the two after the early fifth dynasty.

The titles in table 23 also attest further the granary of the residence (šnwt nt hnw - seen previously in the title imy-r šnwt nt hnw of ny-k3-r' (80)), which seems to have had an independent existence. If it had a consistent body of officials to run it, they did not always mention it in their titles. The possession of a title specifically naming this institution could have been a special privilege, granted here to only three men.

The other important feature is the low number of titles associated with the two granaries (šnwt), and, by inference, the overall control of the granaries of the land. A parallel may again be drawn with the hwt wrt: the vast majority of the subordinate titles in that institution were associated with the singular hwt wrt and not the hwt wrt 6 (see also prwy-ḥd below). When discussing the subordinate titles formed with hwt wrt 6 we proposed that the existence of a full bureaucracy for these courts was unlikely, and it is more plausible that the use of the figure '6' indicated an honoured status in the administration of the hwt wrt (above page 190). It is inherently probable that the same argument can be used with the two occurrences of šnwt: as the only other office incorporating the term šnwt was imy-r šnwt, usually held by very important officials and particularly viziers, it would again be a mark of importance and privilege to be permitted to use this element in another title. sndm-[ib] (table 23, (1) and (16)), who held imy-r zš šnwt, also held a more conventional office (hry-tp šnwt), thus suggesting the former title to be a special position granted him. Nothing more is known about the titular of htpi (table 23, (15)), holder of imy-r zš md3t šnwt. The use of šnwt

in a subordinate granary title probably indicated a functional office while the employment of the dual indicated a special and probably honorary position.

Conclusions

The administration of the state granaries was divided in the fifth dynasty between the **imy-r šnwt** and the **imy-r šnwtj**. Before that time no standardised granary title had existed, but in all probability the titles **imy-r šnwt nbt nt nzwt**, **imy-r šnwt nzwt** and **imy-r šnwt nzwt** represented such an office. Little else is known about the administration in the fourth dynasty; presumably it would have been one of the undefined tasks of the vizier or the overseer of works.

The titulary of a holder of **imy-r šnwt** generally shows that he held other positions within the granary administration, while the **imy-r šnwtj** did not, although two men did attain the latter office from the former. The title of **imy-r šnwt** is not very common, and the principal management of the granary was in the hands of the **imy-r šnwtj**. Viziers principally held the latter position during the sixth dynasty, but there was a reversion to lower-ranking holders at the end of the Old Kingdom.

Confusion may arise between men who were officials at the state granaries and those who worked on private estates. The former were in all probability men of sufficient means to warrant a tomb, while our knowledge of the latter is confined to tomb walls. It seems probable that the hierarchy and administration of the two groups of granaries was the same. The majority of titles connected with granaries are of a scribal and bureaucratic nature.

Little evidence exists for the location of the state granaries. They are however attested as sending grain to other granaries or as supplying offerings to deceased officials. Other types of granaries are occasionally attested.

The granary was one of the principal institutions in the organisation of the Egyptian state, as it was responsible for the grain - and hence food - supply. As such it was also an important element in the financial administration of the land, contributing to the revenue of the treasuries. It is very likely that these two institutions were closely linked.¹ An examination of the titularies of viziers shows that the titles **imy-r šnwtj** and **imy-r prwy-ḥd** there appear together with regularity, and this matter will be discussed in chapter eight. Further similarities will be noted in the next chapter.

1 Noted by Pirenne, *Institutions et Droit* II, 195-6.

7 The Overseers of the Treasurers

General

The titles **imy-r pr-ḥd** and **imy-r prwy-ḥd** appear to have been the most important titles in the administration of the treasury in the Old Kingdom. Their forms closely parallel those of the principal titles in the granaries (chapter 6), but only the following variants are found: **imy-r pr-ḥd n hnw**, **imy-r prwy-ḥd n hnw**, and **imy-r pr-ḥd n snfrw/ḥwfw/ddf-r'** (?). These five titles appear to indicate specific treasuries, but only occur eight times in total. It is again preferable to postpone discussion of these latter forms until the simpler and more frequent ones have been discussed.

Table 24 gives the known holders of the titles. There is only one possible addition to this, the man depicted in a fragment from the mortuary temple of Pepy II.¹ As there is no record of the name of the owner, he is excluded from the table as he might already feature in it.

Two officials are sometimes referred to as 'Overseers of the Treasury' who on closer inspection are not. A title of **ḥtw** is read by Helck **imy-r pr-ḥd**, whereas it is actually **imy-r pr.**² **k3i-'pr** (138) is called 'Overseer of the Two Treasuries' by Porter and Moss.³ As seen in the Prosopography above it is actually **imy-r pr**, **ḥm-k3**, or **imy-r pr ḥm-k3**.

imy-r pr-ḥd appears at the beginning of the fourth dynasty, but most examples are of fifth dynasty date. **imy-r prwy-ḥd** is first found in the middle of the fourth dynasty but is most frequent from the middle fifth onwards. These titles are not common in the provinces, but are found sporadically from the reign of Pepy I to the late Old Kingdom.

1 Jéquier, *Pepi II II*, pl. 72.

2 Beamtentitel, 61 n. 26, following Fisher, *The Minor Cemetery at Giza*, 154 (37); see *id.*, *ib.*, pl. 50 [3].

3 *PM* 3², 205.

Table 24

List of Overseers of the Treasuries

A. Memphite

1. imy-r pr-hd

Early Fourth Dynasty

ph-r-nfr (46)

Middle-late fourth dynasty

mry (58)

nfr (84)

izi (17)

Middle fifth dynasty

k3i-m-qdi (145)

wr-irni (38)

ny-k3w-ptḥ (77)

df3wi (167)

Middle-late fifth dynasty

ḥ'-inpw (101)

nfr (83)

s3mw (128)

k3i-pw-r' (143)

ny-sw-wsrt (74)

End fifth-early sixth dynasty

k3i-dbḥn (153)

'nh-ḥ3f; q3r (35)

2. imy-r pr-hd n hmw

Middle-late fifth dynasty

df3wi (167)

k3i-pw-r' (143)

Name Lost (171)

3. imy-r prwy-hd

Middle fourth-early fifth dynasty Wenis

nfr (84)

3ḥi (1)

* 3ḥt-ḥtp (2)

* 3ḥt-ḥtp; ḥmi (3)

* iḥy (15)

* iy-nfrt; š3nf (6)

Middle fifth dynasty

* k3i (136)

* ph-n-wi-k3i (45)

df3wi (167)

k3i (137)

End 5 - early 6

ḥzzi (98)

* hrmw-nti (113)

Djedkare

* pth-ḥtp (48)

* pth-ḥtp I (49)

* sndm-ib; inti (120)

Teti

* k3i-gmni; mmi (151)

* nfr-s3m-r'; s3i (88)

* 'nh-m-'-hr; zzi (30)

Table 24 continued

'nh-h3f; q3r	(35)	Middle Pepy II	
* mrrw-k3i; mri	(68)		
Early Pepy I			
			hnmw-htp (112)
			* h'-b3w-hnmw; biw (102)
		Later Pepy II or later	
* hnty-k3i; ihhi	(109)		
* mh _w	(69)		
ny-s-nh-3ht; iti	(73)		* ny-hb-sd-nfr-k3-r' (72)
* pth-htp	(51)		izi (18)
			šdy-pt _h ; šdw (134)
Middle Pepy I - early Pepy II			* tti (156)
		First Intermediate Period	
pth-špss	(53)		
mrr _i	(66)		
išfi; twtw	(19)		* ttw (160)
* mrr _i	(67)		
* idw I; nfr	(22)		
* 'nh-mry-r'	(33)		

4. imy-r prwy-hd n hnw

Middle Pepy I

ny-s-'nh-3ht; iti (73)

5. Other Forms

Middle-late fifth dynasty

Name Lost	(172)	imy-r pr- <u>hd</u> n snfrw
		imy-r pr- <u>hd</u> n h _w fw
		imy-r pr- <u>hd</u> n <u>ddf</u> -r'

B. Provincial

1. imy-r pr-hd

Early-middle Pepy II

* 'nh-ppy hny-km Meir¹

1 Blackman, Meir V, 16-56; date, Baer, Rank and Title, 70 (134).

Table 24 continued

2. imy-r prwy-ḥd

Middle sixth dynasty

* iww Abydos¹
 ny-'nh-ppy km; sbk-ḥtp Meir²

Early Pepy II





k3i-ḥp; tti Akhmim³
 ibi Deir el Gebrawi⁴

Middle-late Pepy II

d'w; šm3i Deir el Gebrawi
d'w Deir el Gebrawi⁵

* indicates vizier at some point in his career

The writing of the pr-ḥd group exhibits a degree of variation which may be useful for dating purposes.⁶ Only one form is generally found (the combination of the house and the mace), with no phonetic writings evident. The most important feature is the extent to which the mace sign is enclosed by the house sign. There

are two principal forms:  and . The former is the most common prior to the mid-later fifth dynasty, while the latter is usually found after that time. The latest example of  would seem to be in the tomb of 'nh-ḥ3f; q3r (35) at Giza, perhaps at the beginning of the sixth dynasty, in which tomb  is also

- 1 Cairo, CG 1576, LD Text II, 176 (5); date, Kanawati, *Egyptian Administration*, 33.
- 2 Blackman, *op. cit.*, 1-15; date, Baer, *op. cit.*, 84 (212).
- 3 Kanawati, *Hawawish III*, 7-32, including dating.
- 4 Davies, *Deir el Gebrawi I*, *passim*; date, Baer, *op. cit.*, 56 (32).
- 5 Both d'w 's, Davies, *op. cit.*, 1-13; date, Baer, *op. cit.*, 157 (592). For the separation of the depictions of the two men see Kanawati, *JEA* 63 (1977), 59-62.
- 6 This paragraph is a very brief summary of the development of this group as set forth in the writer's paper to be published in *JEA* 71 (1985).

found.¹ **k3i** (137),² **nfr** (83), **ny-sw-wsrt** (74), Name Lost (171) and Name Lost (172) may be dated to the fifth dynasty by use of these observations.

The Titularies of the Non-viziers

Consideration will firstly be given to the titles **imy-r pr-hd** and **imy-r prwy-hd** as these are the most frequent, and the variant titles will be compared later.

A. **imy-r pr-hd**

Table 25 sets out the holders of **imy-r pr-hd** and the principal groups of titles that they possessed. This title does not seem to have been held by any viziers buried in the memphite region. It is attested four times in the fourth dynasty (**ph-r-nfr**, **izi**, **nfr** (84) and **mry**). The dating of the remaining examples is somewhat vague, but the majority seem to have lived between the reigns of Neferirkare and Djedkare or Wenis. The two latest examples belong either to the end of the fifth dynasty or the beginning of the sixth (**'nh-h3f** and **k3i-dbhn**).

1. Titles Relating to the Treasury

The first group of such titles are obvious ones mentioning **pr-hd** (columns 1-4 of table 25). Helck has noted these and others such as those that mention the **prwy-nwb**, and those connected with the supply of clothing, as well as the appearance of the obscure title **wr bzt**.³

One particular combination of treasury titles is evident from table 25 - that of **imy-r pr-hd**, **imy-ht pr-hd** and **shd zš pr-hd** (three examples). These presumably represent the senior and deputy offices and head of scribes in the treasury.

The title **wr bzt** is found four times in the titularies of these officials. As two of these, **df3wi** and **'nh-h3f**, also held the title of **imy-r prwy-hd**, we cannot tell with which title **wr bzt** should be associated. **k3i-pw-r** was additionally **imy-r pr-hd n hnw**, another holder of which (Name Lost (171)) was also **wr bzt**. Only **izi** was just **imy-r pr-hd** - perhaps this is related to the fact that this was the only one of these titles in existence in the fourth dynasty.

1 Hassan, Giza III, fig. 114-5.

2 Such a date raises the possibility that he could be identical with the vizier **k3i** (136); the latter's writing of the **pr-hd** group cannot be accurately ascertained, and, although the titles **imy-r k3t nbt (nt) nzwt** and **imy-r prwy-hd** are held by both, the honorific titles do not match.

3 Beamentitel, 60-3.

Table 25

Principal Titles of holders of **imy-r pr-hd**

	1	2	3	4	5	6	7	8	9	10	11	12	13	14	15
ph-r-nfr (46)			X	X					0	1	X	X	2		X
nfr (84)								X	4	1	X		1		
mry (58)								X	2	0	X		0		X
izi (17)						X		X	1	0			0		
k3i-m-qdi (145)							X		0	0			0	X	X
wr-irni (38)								X	0	0			0	X	
ny-k3w-pth (77)	X	X			X			X	4	2			0	X	X
df3wi (167)					X	X	X		1	0			1	X	X
h'-inpw (101)					X			X	0	0	X		0	X	
nfr (83)									1	0			0	X	
s3mw (128)									0	0			0		
k3i-pw-r' (143)	X	X				X		X	1	0			1	X	
ny-sw-wart (74)									0	0			0		
k3i-dbhn (153)	X	X					X	X	0	0	X		0		
'nh-h3f; q3r (35)					X	X		X	0	1		X	1		

Key to Columns:

1	imy-ht pr-hd	2	shd z3 pr-hd
3	(shd) iry-ht pr-hd	4	sd3wty ... pr-hd
5	Titles using prwy-nwb	6	wr bzt
7	Titles concerned with linen	8	Titles with hkr nzwt
9	Number of Scribal Titles	10	Number of Legal Titles
11	rh nzwt	12	hry-tp nzwt
13	Number of other High Offices		
14	Royal Institution Titles	15	Religious Titles

One further group of titles which appears quite frequently in the titularies of treasury officials is those incorporating the element **hkr nzwt** (table 25, column 8). Helck does not include these in his survey of treasury titles, but he does attest certain connections that they bear with that institution,¹ and the high number of occurrences here marks this as probable. There are in particular three occurrences of the title **imy-r iz(wy) (n) hkr nzwt (nb)** (**mry**, **h'-inpw** and **'nh-h3f**). This title is often found in conjunction with important officials, many of whom were **imy-r prwy-hd** (below page 285-6). The singular version appears only in the titulary of **mry** of the fourth dynasty, and may well have possessed the same importance as the later dual form, since it is likely at that time that **imy-r pr-hd** represented the same office as **imy-r prwy-hd** later did (below page 291).

1 *op. cit.*, 65-6.

Helck would also include the titles connected with the supply of provisions with the treasury,¹ but here they have been discussed in the context of the granaries (above page 256). Four such examples may be found here: **htm df3w bity** ('nh-h3f), **htm h3t df3w bity** (k3i-dbhn and probably ny-k3w-pth), **imy-r sty df3w** (nfr (84)), and **imy-r swt df3w** (df3wi). These titles are perhaps to be associated equally with the treasury and granary. Incidentally, no granary titles are found with the exception of that held by **ph-r-nfr**, suggesting that, although it will be seen later that the two institutions are often closely linked, there were no obvious connections at the administrative level of **imy-r pr-hd**.

There are three occurrences of the title **imy-r prwy-nwb**, and two of these men were also **imy-r prwy-hd** (df3wi and 'nh-h3f). It is likely that **imy-r prwy-nwb** is more to be associated with **imy-r prwy-hd** than **imy-r pr-hd** (below page 284-5). It is thus possible that the third of these officials, **h'-inpw**, was in fact a holder of **imy-r prwy-hd** as well as **imy-r pr-hd**; the large sections missing from his false door could easily have included this title.

2. Scribal and Legal Titles

The few scribal titles found were principally held by the fourth dynasty officials, who were some of the most important holders of **imy-r pr-hd**. There are a very limited number of legal titles, such as **z3b nht-hrw** (nfr (84)), **mdw rhyt** (ny-k3w-pth), and **z3b 'd-mr** ('nh-h3f), hardly surprising in view of the parallel lack of scribal titles. These two classes of titles did not generally feature in the careers of treasury officials.

3. Honorific Titles

Only three honorific titles appear among the titularies of this group of officials: **smr** (mry), **hry-tp nzwt** (ph-r-nfr and 'nh-h3f), and **rh nzwt** (ph-r-nfr, mry, nfr (84), h'-inpw and k3i-dbhn). Both the holders of **hry-tp nzwt** held other important titles. The majority of these titles occur in the titularies of the fourth dynasty holders of **imy-r pr-hd** who were perhaps more important than their fifth dynasty counterparts. The most frequent honorific title encountered is **rh nzwt** which shows that they were not of the highest status, but ranked similarly to the **imy-r snwt** and **imy-r k3t (nt) nzwt**.

4. High Administrative Titles

With the early exception of **ph-r-nfr**, such titles are restricted to others in the treasury administration. The exact significance of **imy-r pr-hd n hnw** (df3wi and k3i-pw-r') is not yet known (but see section C. below); on the analogy of **imy-r snwty**, **imy-r prwy-hd** would be a higher office in the department. This was attained only by three men, **nfr** (84), **df3wi** and **'nh-h3f**. Like the holders of **imy-**

1 op. cit., 60.

r šnwt, the imy-r pr-ḥd remained within the same institution and promotion to a higher office was rare.

5. Religious Titles

A number of religious titles are found in the titulary of ph-r-nfr, but these do not reappear in those of any other official. Of more interest are the two occurrences of the title ḥm-ntr rnnwtt with mry and dfṣwi. These appear to be the only mentions of this deity in Old Kingdom titles, but rnnwtt may have been a protective goddess with regard to the treasury in the manner of ḥqt and ḥ3 to legal officials and scribes, although the evidence is far more restricted. In the New Kingdom rnnwtt is very often associated with the granary,¹ but there is no clear Old Kingdom evidence for this, only one depiction of what appears to be a stela bearing the figure of a snake (symbol of rnnwtt) alongside tomb scenes of measuring grain.² The reason for the apparent Old Kingdom association of rnnwtt with the treasury may lie in her being (in some contexts) the personification of linen,³ which commodity has been identified above as a responsibility of the pr-ḥd.

The title w'b nzw't appears twice (k3i-m-qdi and ny-k3w-ptḥ). It is most frequently found with officials not of the higher ranks, and particularly together with the title rh nzw't. These two officials do not hold the latter title, but it is not uncommon among their fellow holders of imy-r pr-ḥd.

6. Titles related to Royal Institutions

Column 14 of table 25 shows that such titles are very frequent, held by almost every fifth dynasty holder of imy-r pr-ḥd. They are as follows:

k3i-m-qdi (145)	ḥm-ntr r' m st-ib-r'
wr-irni (38)	ḥm-ntr r' m nhn-r'
	ḥm-ntr r' m st-ib-r'
ny-k3w-ptḥ (77)	ḥm-ntr s3ḥw-r'
	ḥm-ntr r' m nhn-r'
dfṣwi (167)	ḥm-ntr ny-wsr-r'
ḥ'-inpw (101)	ḥm-ntr b3-nfr-ir-k3-r'
	ḥm-ntr ny-wsr-r'
nfr (83)	imy-r zš 3ḥt-ḥwfw
	hry-sšt3 3ḥt-ḥwfw
k3i-pw-r' (143)	ḥm-ntr nfr-dd-k3-r'

These are all, with the exception of k3i-pw-r', examples of what we may term 'old-style' priesthoods, which are basically relatively low-ranking offices (above, page 186). This again generally follows the pattern established for imy-r šnwt and imy-r k3t (nt)

1 Leibovitch, JNES 12 (1953), 74; cf. Kaplony, Fs Berlin, 147-8.

2 Tomb of 'nh-ḥ'f-r' at Giza, LD II, 9 (lower).

3 cf. Broekhuis, de Godin Renenwetet, 79-85.

nzwt. Royal priesthoods in the fourth dynasty were generally reserved for privileged officials or members of the royal family, and the newer style priesthoods (later fifth dynasty and later) were usually confined to more important officials.

7. Other Titles

Only one further title calls for particular comment, **imy-r pr-'h3w**, held by **mry**, **nfr** (84) and **h'-inpw**.¹ Some link between the treasury, granary and **pr-'h3w** is suggested by Helck.² From these occurrences it is possible that it was closely associated with the treasury, perhaps because the provision of weapons (and perhaps tools³) would be made from the national expenditure.

B. **imy-r prwy-hd**

There were thirty-seven memphite holders of this title in the Old Kingdom, of which twenty-four were viziers. The remaining thirteen will be discussed here, and their names and principal titles will be found in table 26.

1. Titles relating to the Treasury

Table 26 shows in columns 1-8 a selection of such titles. Those actually mentioning the treasury are different from those in table 25 above, and are confined to two men, **ny-s'nh-3ht** and **izi**. The latter's treasury titles in fact mention the **prwy-hd**, not the **pr-hd** as in other cases.

The title **wr bzt** appears with about the same frequency as with **imy-r pr-hd**. Titles associated with clothing are found only with **df3wi**; as he held **imy-r pr-hd** as well it is not impossible that such titles are to be associated more with that title than **imy-r prwy-hd**.

imy-r prwy-nwb is more common with **imy-r prwy-hd** than **imy-r pr-hd**. Looking more generally at this title, it is most frequently found in conjunction with **imy-r prwy-hd**: of the eighteen known Old

- 1 **mry** and **h'-inpw** write this title and **imy-r pr-hd** together in the same manner, with the **imy-r** element applying to both titles (see page 120 n. 2).
- 2 **op. cit.**, 65.
- 3 Metal is a feature common to tools and weapons, and royal expeditions and building projects must have required them, although the issue of these cannot be directly linked with the treasury. However, the metals gold and silver have indirect links with the **pr-hd**, and this may be so for other metals. The value and importance of metal in the work of craftsmen may be judged from the (later) accounts of weighing tools and the like, for example in Papyrus Reisner II (Middle Kingdom; Simpson, **Papyrus Reisner II**, 24 ff), and, more generally, at Deir el Medina (cf. Černý, **CAH II**, pt. 2, 621).

Table 26

Principal Titles of non-viziers who held imy-r prwy-hd

	1	2	3	4	5	6	7	8	9	10	11	12	13	14	15
<u>nfr</u> (84) *								X	2	1	R				1
<u>3hi</u> (1)									0	1					2
<u>df3wi</u> (167) *					X	X	X		1	0					1
<u>k3i</u> (137)									0	0		X			1
<u>h3zi</u> (98)									1	0	H				2
<u>'nh-h3f; q3r</u> (35) *					X		X	X	0	1	H				1
<u>ny-s'nh-3ht</u> (73)		X				X	X	X	0	1		X			0
<u>pth-špss</u> (53)									0	0		X	H	0	X
<u>mrr</u> i (66)							X	X	0	0	H	X	H	0	
<u>išfi</u> (19)									0	0		X			1
<u>hnmw-htp</u> (112)								X	0	0		X	X		1
<u>izi</u> (18)	X			X	X				1	2	H	X			0
<u>šdy-pt</u> h (134)								X	0	0					0

* indicates also holder of imy-r pr-hd

Key to Columns:

1 <u>imy-ht prwy-hd</u>	2 <u>šhd zš pr-hd</u>
3 <u>imy-r zš prwy-hd</u>	4 <u>iry wd3 prwy-hd</u>
5 <u>wr bzt</u>	6 Titles concerned with Linen
7 Titles using <u>prwy-nwb</u>	8 Titles using <u>hkr nzwt</u>
9 Number of Scribal Titles	10 Number of Legal Titles
11 R = <u>rh nzwt</u> , H = <u>hry-tp nzwt</u>	12 <u>smr w'ty</u>
13 H = <u>h3ty-</u> , X = <u>iry p't</u> and <u>h3ty-</u>	
14 Number of other High Offices	15 Royal Institution Titles

Kingdom examples, only four are not in this combination (smnhw-pth,¹ sndm-ib; mhi (121), ny-k3w-izzi (76) and 'nhi; inti²). The first and last of these four are probably associated with this title by virtue of being metal-workers; of the others, the titular of ny-k3w-izzi (76) is not yet complete, and as sndm-ib; mhi (121) was one of the few viziers to hold imy-r šnwty but not imy-r prwy-hd one wonders whether this is not true of him also.

The term hkr nzwt (column 8 of table 26) appears most frequently in the title imy-r izwy hkr nzwt. nfr (84) is the only official marked in this column who did not hold this title; however, he seems to have lived before its introduction. imy-r izwy hkr nzwt is frequently found associated with imy-r prwy-hd (seventeen out of

1 Mariette, Mastabas, 29.

2 Goyon, Kémi 15 (1959), pl. V (8).

twenty-seven examples), but the former is not necessarily subordinate to the latter. It is however most frequently held either by viziers or **imy-r prwy-ḥd** (or holders of both). Exceptions to this rule tend to have held titles which may have been under the control of the **izwy n hkr nzwt**,¹ or else were very high officials in the sixth dynasty, where their importance as officials may have resulted in their overseeing this department.² The **izwy hkr nzwt** thus appear to have formed an independent department, but very closely linked to the treasury, concerned principally with certain personal services to the king (for example, hairdressing (**iri šn**)), as well as oils and metals, which are often associated also with the treasury.

Titles bearing some relationship with the treasury are thus evident in the titularies of these **imy-r prwy-ḥd**. It is not clear however as to which of them were held prior to receiving this office, and consequently one cannot say whether these officials had an earlier career in the treasury. **nfr** (84), **df3wi** and **'nh-ḥ3f** seem to have been promoted from **imy-r pr-ḥd** but it is perhaps likely that many of the other officials had no such experience.

2. Scribal and Legal Titles

Examples of neither category are common, legal titles being only slightly more frequent than scribal ones. The title of **z3b 'd-mr** is found with **3hi**, **'nh-ḥ3f** and **ny-s'nh-3ht**, although this scarcely represents any consistent tenure of this position.

3. Honorific Titles

Some similarity is evident here with the pattern noted above for **imy-r šnwty** and **imy-r k3t nbt (nt) nzwt**. Ranking titles are not particularly common with this group of officials before the end of the fifth dynasty. **nfr** was **rh nzwt**, doubtless a higher title in the fourth dynasty than in succeeding periods; the only honorific title in the fifth dynasty is **smr w'ty n mrwt** held by **k3i** (137). He also held several 'courtly' titles as will be seen below. It is generally difficult to draw conclusions for the fifth dynasty on this limited evidence.

With the exception of **šdy-ptḥ**, the sixth dynasty holders of **imy-r prwy-ḥd** all held **smr w'ty** or **hry-tp nzwt** (or both). Additionally, **ptḥ-špss**, **mrrī** and **hnmw-ḥtp** were **ḥ3ty-**, and the latter added **iry p't** as well. **mrrī** and **ptḥ-špss** have the common feature of possessing tombs in the northern section of the Teti Pyramid Ceme-

-
- 1 Helck, *Beamtentitel*, 65-6; metalworkers can probably be added to his list. Some examples: **pr-sn** (Petrie-Murray, *Memphite Tomb Chapels*, pl. IX) was **imy-r mrḥt hkr nzwt**; **r'-wr** (Hassan, *Giza I*, pl. XI, XXX) was **iri šn**; **pr-ndw** (Giza, Eastern Cemetery, unpublished), was a metalworker; **dmd** (Cairo, CG 1323), was **imy-r nwb pr-3**.
 - 2 **nfr-sšm-ptḥ** (87) (later career) and **nḥri** (Jéquier, *Pepy II III*, fig. 62).

tery, which may bear some relation to their rank.¹ The most significant feature is however the consistent ranking of all these men as **smr w'ty** or **hry-tp nzwt**, placing them on a level with their colleagues who held **imy-r šnwty** and **imy-r k3t nbt (nt) nzwt**. The example of **izi** shows this rank to have been the same in the late Old Kingdom, although the number of examples is very limited.

One further title of a courtly and probably honorific nature stands out by its four appearances - **hry-sšt3 n pr-dw3t**, found with **k3i** (137), **mrrī**, **išfi** and **šdy-ptḥ**. The appearance of this title among officials discussed before has been very sporadic and not noted; while by no means frequent here, it is held by almost a third of the **imy-r prwy-ḥd**. A brief survey of all its holders reveals many of them to have been principally men who were concerned more with the direct service of the king than as opposed to those who held real administrative offices.² They seem very much to have formed a royal 'court'. Viziers are of course an exception to this as they had to fulfil both roles. Non-viziers with real administrative titles are not often found among this group, and some are noted above as rather honoured and special officials (for example, **ty** (157) and **ztw** (115)). In the fifth dynasty **hry-sšt3 n pr-dw3t** is frequently found together with titles such as **smr**, **hrp 'ḥ** and **hry-wdb m ḥwt-'nh** (for example **k3i** (137) here), but it is the only title to appear consistently in the sixth. Its holders here should perhaps again be regarded as specially favoured officials, members of the 'court'. Thus generally the **imy-r prwy-ḥd** had a rank not unlike that of the holders of some other high titles in the fifth and especially sixth dynasties.

4. Other High Administrative Titles

Leaving aside **nfr**, **df3wi** and **'nh-ḥ3f** who were additionally **imy-r pr-ḥd**, and **ny-s'nh-3ḥt** who was **imy-r prwy-ḥd n hnw**, the pattern of other high titles found is shown below:

	1	2	3	4
3ḥi (1)			X	X
k3i (137)			X	
hzzī (98)			X	X
išfi (19)				X
hnmw-ḥtp (112)				X

Key to Columns:

- | | |
|----------------------------------|--------------------------|
| 1 imy-r ḥwt wrt | 2 imy-r zš ' nzwt |
| 3 imy-r k3t nbt (nt) nzwt | 4 imy-r šnwty |

-
- 1 Compare the rank of other non-vizierial officials from the same area, such as **ny-k3w-izzi** (76) and **mrw** (64).
 - 2 cf. Helck, *Beamtentitel*, 43; other such titles, *id.*, *ib.*, 68.

The conclusions to be drawn are very different from those in previous chapters, as tenure of these titles is confined only to **imy-r k3t nbt (nt) nzwt** and **imy-r šnwty**. The occurrence of **imy-r šnwty** in four out of five examples suggests a close link between these two departments. Why **imy-r k3t nbt (nt) nzwt** should be present in three cases is not clear; it is however the most common of the high administrative titles down to the middle sixth dynasty, and as its functions are very wide-ranging its presence should come as no surprise. The relative lack of fifth dynasty examples of **imy-r prwy-ḥd** accounts partly for the non-appearance of **imy-r ḥwt wrt** and **imy-r zš 'nzwt**; in the sixth dynasty the holders of **imy-r ḥwt wrt** are of much lower rank than the **imy-r prwy-ḥd**, while non-vizierial holders of **imy-r zš 'nzwt** are almost non-existent. The lack of legal and scribal titles in the titulary of a typical **imy-r prwy-ḥd** may be an additional factor.

The majority of holders of **imy-r prwy-ḥd** did not hold important positions in the other major areas of the administration covered by this study. This supports the contention that it was deliberate policy in the sixth dynasty for most high officials to hold the principal office of only one department of the administration, more titles being conferred only on very special officials, the greatest number of whom were viziers.

5. Religious Titles

The only religious title found in more than one instance is **hry-ḥb (k3i (137), pth-špss, mrrī and išfi)**. These men all held the title **smr w'ty**, and there is a clear link between the two titles. For the title of **ḥm-ntr rnnwt (df3wi)** see above page 283.

6. Titles associated with Royal Institutions

The following such titles are found with the holders of **imy-r prwy-ḥd**:

df3wi (167)	ḥm-ntr ny-wsr-r'¹
pth-špss (53)	šḥd ḥm-ntr dd-swt-tti
izi (18)	imy-ḥt ḥm-ntr dd-swt-tti
	mty n z3 dd-swt-tti
šdy-ptḥ (134)	imy-r wpt mn-'nh-nfr-k3-r' ppy
	w'b 200 mn-'nh-nfr-k3-r' ppy

The sixth dynasty titles may to some extent be related to the rank of their holders: **pth-špss** held the high rank of **ḥ3ty-** and the most elevated office in connection with the royal pyramid; the next highest offices were held by **izi** who was **smr w'ty**, and then we find

1 It is unclear whether this title of **df3wi** is to be related to his tenure of **imy-r pr-ḥd** or **imy-r prwy-ḥd**; on the more frequent occurrences of similar titles with the former one might suggest it to be associated more with **imy-r pr-ḥd** (cf. table 25 and pages 283-4 above).

šdy-ptḥ who has no surviving ranking titles. It would seem that the tenure of these titles is related more to the officials' rank and status in relation to the king than to the presence of **imy-r prwy-ḥd**.

7. Other Titles

Titles with **wd(t)-mdw** appear very infrequently with the holders of **imy-r prwy-ḥd**, only being found with **k3i** (137) and **išfi**. These two both held more than one high administrative title, which continues to support the contention that titles with **wd(t)-mdw** were often associated with the highest officials.

The title of **imy-r šwy** () **pr-'3** is found three times with officials of broadly similar date (**ptḥ-špss**, **mrri** and **išfi**). It probably represents the most important title in the department concerned with weaving,¹ and doubtless had associations with the treasury because of the latter's concern with woven material.

C. Conclusions on Titularies and Discussion of Variants

The conclusions from the foregoing are very similar to those obtained for **imy-r šnwt** and **imy-r šnwtj**, namely that the **imy-r pr-ḥd** show a far higher degree of involvement with other aspects of treasury administration than do the **imy-r prwy-ḥd**. The latter title is definitely the higher ranking and thus presumably the more important of the two.

Two of the variant forms of these titles are distinguished by the addition of the element (n) **hnw**. There are three instances of **imy-r pr-ḥd n hnw**, **df3wi** (167), **k3i-pw-r'** (143) and Name Lost (171), and one of **imy-r prwy-ḥd n hnw** (**ny-s'nh-3ḥt** (73)). As far as can be discerned, only Name Lost (171) did not hold the simple title without the **hnw** element, and thus the separation of distinctive features is rather difficult. The only other title certainly held by this man is **wr bzt**, also found with the three other officials named above; as noted earlier (page 280), it does not seem to occur with men who held the title of **imy-r pr-ḥd** after the fourth dynasty. **wr bzt** otherwise appears with two **imy-r prwy-ḥd** (**'nh-ḥ3f**; **q3r** (35) and **izi** (18)), and consequently is a treasury-related title. The **imy-r pr-ḥd n hnw** may have been specially treated by the granting of the uncommon title **wr bzt**, and although their other titles do not seem to distinguish them from the **imy-r pr-ḥd**, they may perhaps have been slightly more honoured officials, holding a title otherwise given only to the higher **imy-r prwy-ḥd**. The evidence is insufficient to note any further special features of **imy-r prwy-ḥd n hnw**.

The other variant forms are all held by the same man (Name Lost (172)), and apparently refer to treasuries of the kings Sneferu,

1 Junker, Giza V, 12-13; Helck, *Beamtentitel*, 63.

Khufu and Djedefre, although this arrangement of the blocks is not altogether certain. This man's only non-treasury titles are **zš 'nzw**t and **imy-r iz** ///. Such scribal titles make the occasional appearance, but titles beginning **imy-r iz** are quite common in the titularies of treasury overseers, particularly **imy-r izwy hkr nzw**t (above page 281, 285-6). The very limited evidence from this tomb suggests that his titulary, like that of the other variants, was not dissimilar to that of an ordinary **imy-r pr-hd**.

The Viziers

imy-r prwy-hd is the only treasury title held by viziers, a total of twenty-four examples. Their titularies contain no subordinate titles in the treasuries. Two titles associated with linen are found, **imy-r sšr** (**hnty-k3i** (109)) and **imy-r sšr nzw**t (**sndm-ib; mhi** (121)). By far the most common treasury-related term in the titles of the viziers is **hkr nzw**t, particularly in the form **imy-r izwy hkr nzw**t. Titles incorporating this element are found in the titularies of almost all viziers who also held **imy-r prwy-hd**. **imy-r izwy n hkr nzw**t is doubtless held by viziers to indicate their authority over this department. The titulary of **k3i** (136) shows that he did not hold the title of **imy-r prwy-hd** until he became vizier, and he had no titles vaguely connected with treasury administration before this promotion. This gives a clue to the problem of the titles with **hkr nzw**t: in his case the title **imy-r hkr nzw**t **m izwy** was associated with his promotion to vizier and **imy-r prwy-hd**, which indicates that the presence of such a title in the titulary of a vizier need not signify that he held it earlier in life.

The Administration of the Treasury

A. The Overseers of the Treasuries

The title **imy-r pr-hd** seems to be confined to the period from the fourth to very early sixth dynasties (**ph-r-nfr** (46) to **'nh-h3f; q3r** (35)). It seems to have disappeared at about the same time as did **imy-r šnwt** and a little later than the date at which the title **imy-r zš 'nzw**t became confined to the vizier only, that is, towards the end of the fifth dynasty.

The title of **imy-r prwy-hd** made its first appearance in the later fourth dynasty (**nfr** (84) and **3hi** (1)), but then is not found again until it was held by viziers in the middle of the fifth dynasty (**k3i** (136) and **ph-n-wi-k3i** (45)). Its occurrences in the titularies of non-viziers in this dynasty are very restricted (**k3i** (137) and **df3wi** (167)). Apart from two **imy-r pr-hd** at the beginning of the sixth dynasty, **k3i-dbhn** (153) and **'nh-h3f; q3r** (35), only holders of **imy-r prwy-hd** are found in that period, nine non-viziers and fourteen viziers.

It would seem that the treasury was generally administered in the fourth and fifth dynasties by an **imy-r pr-hd**, with a vizier holding **imy-r prwy-hd** from the mid-fifth dynasty. The infrequent appearances of non-vizierial **imy-r prwy-hd** are not easy to explain.

The two fourth dynasty examples both come from tombs at Giza, while their counterparts at Saqqara were only imy-r pr-ḥd. It is possible that as the most important officials of this time were buried at Giza, the new title would have made its first appearance there. One is tempted to regard the titles imy-r pr-ḥd and imy-r prwy-ḥd at this time as representing similar levels of authority; it was only with the apparent expansion of the number of treasury overseers in the early fifth dynasty that the writings came to represent different functions. Otherwise, the earliest imy-r prwy-ḥd were either very high officials who bore another important office (k3i (137)) or those who were presumably promoted from imy-r pr-ḥd (df3wi (167) and 'nh-ḥ3f; q3r (35)). The infrequency of imy-r prwy-ḥd with non-viziers suggests that such occurrences in the later fifth dynasty were special appointments, elevating a man to an office otherwise associated only with the vizier.

The holding of the office of imy-r prwy-ḥd by non-viziers was set on a more regular basis in the early sixth dynasty. However, the number of non-viziers is surely insufficient for a continuous succession in the office considering the length of the period, and it must be assumed that the vizier bore a large measure of control of the institution. In this respect the high offices of the granary and treasury are again parallel, especially as both continued to be held by non-viziers during the sixth dynasty.

In the opinion of Helck, the men in charge of actual treasuries were the imy-r pr-ḥd, and the vizier and others who were in overall control of the department bore imy-r prwy-ḥd.¹ For the fifth dynasty this seems to fit the evidence - the imy-r pr-ḥd was an official who seems to have spent much of his working life in the treasury and was presumably responsible for everyday matters, and the vizier and other special officials held the dual version of the title.²

In the sixth dynasty however, there seem to be only imy-r prwy-ḥd. Unless the holders of imy-r pr-ḥd did not have the means to build a tomb (perhaps unlikely), the office seems to have disappeared. Most likely the non-vizierial imy-r prwy-ḥd took over part of the role, with perhaps more direct involvement on the part of the vizier.

As with imy-r šnwt, it is perhaps unlikely that holders of imy-r pr-ḥd were responsible for treasuries of private estates.³ However, due to the small amount of evidence of any private treasury administration from tomb scenes (details below on page 293-4), we cannot be sure that such institutions did not exist on private estates.

The only certain example of a specific treasury as mentioned in titles is that of the 'treasury of the residence' (pr(wy)-ḥd n hnw). References to this institution date from the later fifth and early sixth dynasties, and are only slightly more frequent than those which mention the 'granary of the residence' (šnwt nt hnw).

1 Beamtentitel, 58, 61.

2 Indicating the treasuries of the Two Lands and therefore the whole country, in order to represent overall responsibility.

3 Suggested by Kaplony, Studien zum Grab des Methethi, 88.

With such a lack of evidence it is impossible to tell whether this is indeed the principal state treasury, with the official being allowed the honour of so mentioning it in his titles, or a special one for the personal benefit of the king and his household.

The other evidence for the existence of independent treasuries is less clear. An official whose name is lost (172) may have been overseer of treasuries of Sneferu, Khufu and Djedefre, although such a reconstruction of these blocks is far from certain. The only similar reference is to a treasury at the pyramid of Merykare in the First Intermediate Period.¹ Unfortunately, the Abusir Papyri shed no additional light on this problem.

Into this picture of the treasuries must be fitted the provincial holders of the titles, listed in table 24. There are six holders of **imy-r prwy-ḥd** and one (apparently) of **imy-r pr-ḥd**. The latter title of 'nh-ppy ḥny-km of Meir appears in close proximity to that of the vizierate,² and we have seen that in the Memphite Region only the title **imy-r prwy-ḥd** is found in the titulary of the vizier. It is suggested that **imy-r pr-ḥd** here is in fact **imy-r prwy-ḥd** abbreviated for uncertain reasons, perhaps lack of space.

These treasury titles are found on monuments from Abydos, Meir, Deir el Gebrawi and Akhmim. The Abydene connection is particularly strong as the three holders of **imy-r prwy-ḥd** buried at Deir el Gebrawi were also nomarchs of Abydos.³ Although only two of its holders were viziers (**iww** and 'nh-ppy ḥny-km), this title is most frequently associated with the two nomes in which were buried the greatest number of provincial viziers and very high officials in the sixth dynasty - Abydos and Meir. The holders of this title are less widely spread out over Upper Egypt than the holders of **imy-r šnwtj**. The reason for this may be that if, as is normally assumed, the treasury was responsible for revenue collection, overseers of this institution would perhaps not have to be quite so close to the sources of revenue as would the granary officials to the sources of grain. This title is found very frequently in the provinces together with **imy-r šnwtj** (only **iww** of these examples does not hold this latter title), and stresses the link between the institutions.⁴

The establishment of **imy-r prwy-ḥd** in the provinces may go some way to accounting for the decrease in the number of memphite overseers of the treasury in the sixth dynasty who were not viziers. The majority of these provincial officials date from the second half of the dynasty when there are few memphite non-vizierial **imy-r prwy-ḥd**. Such a gradual devolution of responsibility to a local level would necessitate fewer officials in the capital, which in turn indicates that in the fifth dynasty the number of officials

1 ḥtpi, Quibell, *Excav. Saqq.* (1906-07), pl. VI (3).

2 Blackman, *Meir V*, pl. XL (top right).

3 Kanawati observes that the title of **imy-r prwy-ḥd** was not held by the later nomarchs of Deir el Gebrawi who held control in the twelfth Upper Egyptian Nome alone (*Governmental Reforms*, 90).

4 cf. Kanawati, *op. cit.*, 74 (d).

must have been sufficient to manage the revenues of all parts of the country.

B. Other Aspects

There is very little direct evidence as to the precise functions of the treasury. The incidence of treasury officials in tomb-scenes is very low in comparison to those of the granaries; it is possible that this is a reflection of the lack of private treasuries in funerary estates parallel to private granaries, although we will see below that some sources can be best interpreted by assuming that the financial administration of an estate was sometimes termed **pr-ḥd**. In only the following examples are treasury officials seen acting probably in their official capacity.¹

zš pr-ḥd

- 1 Junker, Giza V, Abb. 9
Shown recording linen
- 2 Hassan, Saqqara I, pl. XXI B
Shown writing with the remains of a text above beginning **d3d3t** //, presumably **d3d3t nt pr-dt**
- 3 Junker, Giza IV, Abb. 9
Shown writing, with behind him the **d3d3t nt pr-dt**.

zš sd3wty pr-ḥd

- 1 LD II, 56a bis.
Shown seated, writing, between a man who is described by the text **ipt ḥt šnwt**, 'making the accounts of the granary', and another described as **ipt ḥt imy-r pr**, 'making the accounts of the imy-r pr'.

iry-ḥt pr-ḥd

- 1 LD II, 96 (bottom)
Stands at the end of a register watching men carrying boxes of linen, above whom is the text **stp r pr-ḥd**, 'transporting to the treasury'.

The **zš pr-ḥd**, as one might expect, is shown involved with the process of making records of the activities he surveys. His presence in the **d3d3t nt pr-dt** may be as a state official concerned with the dues of the estates, but this can also be construed as evidence for a treasury administration on some private estates. The **zš sd3wty pr-ḥd**, may in fact be noting down what is being

1 Some examples of such officials acting as offering bearers and the like: Murray, Saqqara Mastabas I, pl. VII; Petrie-Murray, Memphite Tomb Chapels, pl. XIV.

recorded by the scribes either side of him; he was certainly concerned with creating documents. Finally, the *iry-ḥt* is clearly watching over the interests of the treasury in this particular scene.

The first and last examples quoted above confirm the observation made previously that the treasury was concerned very much with types of linen. Also in the tomb of *3ḥt-ḥtp* there is the following

text in a scene of rewarding weavers: *tzt*  *r pr-ḥd*, 'taking

(some form of linen) to the treasury'.¹ Likewise the biography of *d'w* from Deir el Gebrawi refers to various types of linen for bandaging as coming from the two treasuries,² and offering formulae frequently refer to *ḥbs m prwy-ḥd*, 'clothing from the two treasuries'.³

The offering formula of the dog *'bwtwy* shows that coffins as well as linen could come from this institution.⁴ Other texts simply refer to offerings (especially *prt-ḥrw*) generally as coming from the treasury.⁵ In the Abusir Papyri, *mrḥt* oil is shown coming from the *pr pr-ḥd*, perhaps 'the administration of the treasury'.⁶ This latter reference is important in that it serves to link further the treasury and the *izwy* (probably the *izwy n ḥkr nzwt*) as this oil is often mentioned in offering formulae as coming from the latter institution.⁷ The same text is also significant for the only mention of the 'department of the treasury' (*pr pr-ḥd*) in the Old Kingdom. The organisation of scribal departments is often expressed in such terms, for example, the *pr ḥry-wdb* and the *pr md3t*, but nothing comparable has been found for the granaries or for labour organisation. It is very likely that it was largely synonymous with *pr-ḥd*.

Also in the Abusir Papyri, a *shd iry-ḥt pr-ḥd* named *ny-m3't-inpw* is recorded with other officials bringing bricks to the temple;⁸ the precise nature of his involvement with this institution is unknown. The other officials in the document hold a wide range of titles, some of which are *shd iri šn pr-'3*, *iri 'nwt pr-'3*, *shd ḥsw pr-'3*, *zwnw pr-'3*, *z3b shd zš*, *qbḥ ḥwt-nmt pr-'3* and *z3b iry nḥn*. The only common link between these very varied officials is that they were all part of the central or royal administration.⁹ There

1 cf. Posener-Kriéger, *ArchAb* II, 600.

2 *Urk.* I, 146.11-13; Davies, *Deir el Gebrawi* II, pl. XIII (13).

3 Examples: *k3i-m-snw* (144), *Urk.* I, 175.10-12; *sh̄m-k3i*, *Urk.* I, 177.2-4; *k3i-pw-r'* (143), *Urk.* I, 177.8-10 (translated on pages 269-70); *snfrw-nfr*, *Urk.* I, 178.5-6; *s3bni*, *Urk.* I, 138.4-9.

4 Fischer, *ZAS* 93 (1966), 57.

5 *s3bw*; *ibbi* (116), *Urk.* I, 177.14-6; *ḥzzi* (98), Cairo, CG 1413; *ny-k3w-r'*, Cairo, CG 1414.

6 *HPBM*, pl. LXXIIIB; Posener-Kriéger, *ArchAb* II, 426.

7 See especially the above-quoted texts of *k3i-pw-r'* and *snfrw-nfr*.

8 *HPBM*, pl. LXXII (9), reconstructed from pl. LXXXVIII E.

9 This juxtaposition of titles with *pr-'3* and those without

may be no other connecting thread between them, so the treasury official need not be carrying out the functions inherent in his title in this instance. However, this group of officials may also be viewed as a selection of royal servants (notably those with **pr-ʿ3** in their titles) accompanied by treasury and legal officials for the purposes of administration.

Another interesting document concerning the work of the treasury comes from the tomb of **ftk-t3** at Saqqara/Abusir. Above a scene of men sealing wine jars is the text **htm r pr-hd m irp n hwt-k3**, perhaps, 'sealing wine from the **hwt-k3** for the treasury'.¹ This apparently refers to dues being paid in the form of wine; even if it should refer to a treasury on a private estate, there is no reason why wine cannot by analogy be added to the list of concerns of the state treasuries.²

Clearly, the treasury was involved with private estates and tombs, partly from the viewpoint of recording of dues, but also beneficially as providing at least some part of the tomb-offerings, doubtless as indicated by the **hṭp di nzwṭ** formula. As with the granaries, a relationship is attested to some extent between the state treasuries and the magazines of the royal mortuary temple, although there is no evidence as to whether an actual part of this complex was termed **pr-hd**.

More is known about the treasury from later evidence.³ The New Kingdom gives us the most information as to the role of the treasury in the collection of taxes, where it is seen as the responsibility of the vizier.⁴ Of particular interest from the Middle Kingdom is an inscription from the reign of Senwosret I in the Wadi Hammamat, where the equipping of an expedition is split between the granary, treasury and the royal storehouse.⁵ The granary provided the bread and beer, the royal storehouse the meat and fowl, and the treasury the technical equipment. Clearly the granary supplied the grain-based products; it would appear that the treasury was responsible for the non-food supplies. This text thus shows how the treasury and the granary would work together on such a task. Another source of the same date shows the **zš pr-hd whmy** making the accounts of the days worked and the consequent pro-

suggests that the latter group belonged to the royal or central administration without needing to specify it, further emphasising that the **pr-hd** referred to in the titles **imy-r pr-hd** and **imy-r prwy-hd** is the state one.

- 1 LD II, 96 (middle).
- 2 One other potentially interesting reference to the treasury in the Old Kingdom is unfortunately bereft of its full context: in his biography, **3ht-hṭp; hmi** (3) addresses officials of the treasury, but the text of his speech is lost (Hassan, Saqqara I, fig. 18 (l. 50)).
- 3 Summary, Helck, *Verwaltung*, 180-91, particularly with reference to the New Kingdom.
- 4 *id.*, *ib.*, 185-6.
- 5 See also above page 267; comments, Mueller, JNES 34 (1975), 261-2.

visions of the royal dockyard of This.¹ This official is not organising the actual supply, but perhaps was assessing the treasury's outlay which would then be provided by the granary.

Table 27 is our last source, namely further treasury titles found in the titularies of tomb-owners. These are not as informative as we might like, and, with one exception, give us no more information about individual treasuries. Clearly, scribal titles were the most frequent, followed by those composed with *iry-ht* 'administrator'; we have seen illustrations above of the functions of some such officials. These titles also show us officials concerned with sealing (2), and there is one reference to the 'storehouse of the two treasuries' (15). We have seen officials of the rank of *nht-hrw* either in a legal context (page 196) or actually concerned with the products which were the central concern of the department (page 272). Perhaps they supervised the products which came and went as revenue and expenditure (6-7). The link with the central bureaucracy is shown by the title *shd zš 'nzw pr-hd*, also implying the existence of further officials about whom nothing is known. By virtue of their frequency it would seem likely that *imy-ht pr-hd* and *shd zš pr-hd* were the most important titles below that of overseer. Most of the occurrences listed belong to the sixth dynasty, and show that although the overall head of the treasury was no longer *imy-r pr-hd* but *imy-r prwy-hd*, the singular form was used for the lower offices. We have seen that titles subordinate to that of *imy-r* incorporating the elements *hwt wrt* 6 or *šnwty* are rare, and that the administrators normally used the forms *hwt wrt* and *šnwt*. The same is clearly true of the treasury. The only examples of lesser titles using *prwy-hd* belong to *izi* (18) and *hpti* (13-15) either these men were granted special titles employing this term, or else (especially as they are the two latest officials in table 27) the forms *pr-hd* and *prwy-hd* had become largely synonymous by the end of the Old Kingdom.

Apart from the treasury titles of *ph-r-nfr* (46), the oldest in table 27 is *hrp pr-hd*, held by *k3i-'pr* (139) in the early fifth dynasty. Fischer has noted that the use of the title *hrp* is a little unusual in this man's inscriptions.² It is conceivable that as there are few known holders of treasury titles at this date, that of *k3i-'pr* may have represented the most important office in this institution prior to the establishment of *imy-r pr-hd* and *imy-r prwy-hd* on a regular basis. Also, like two other early treasury officials (*ph-r-nfr* (46) and *3hi* (1)), he held one of the overseer of works titles.

The position of *shd pr-hd* in the treasury hierarchy appears to have been lower than that of *imy-ht pr-hd*, as several holders of the latter, but none of the former, attained the level of *imy-r pr-hd*. Relative rankings of some of the other titles may be obtained from an examination of the titularies (admittedly limited in number) of some officials who bear more than one treasury title in a rankable sequence. In the tomb of *k3i-m-'nh*, the sequence *zš pr-*

1 Simpson, *Papyrus Reisner* II, 32-3, 41-2 (10).

2 JNES 18 (1959), 267 (20, 21).

Table 27

Treasury Titles held by Tomb owners

Title	Number of Holders
1 <u>hrp pr-hd</u>	1
2 <u>hry sd3wty pr-hd</u>	1
3 <u>imy-ht pr-hd</u>	6
4 <u>iry-ht pr-hd</u>	2
5 <u>shd iry-ht pr-hd</u>	6
6 <u>shd nht-hrw n pr-hd</u>	1
7 <u>nht-hrw pr-hd</u>	1
8 <u>shd pr-hd</u>	3
9 <u>shd zš pr-hd</u>	7
10 <u>zš pr-hd</u>	6
11 <u>shd zš^r nzwt pr-hd</u>	1
12 <u>zš pr-hd w3d-swt-mry-k3-r'</u>	1
13 <u>imy-ht prwy-hd</u>	2
14 <u>imy-r zš prwy-hd</u>	1
15 <u>iry wd3 prwy-hd</u>	1

References:

- 1 k3i-'pr (139) - Fischer, *JNES* 18 (1959), pl. IX (A)
- 2 ph-r-nfr (46) - Junker, *ZAS* 75 (1939), 64 (3)
- 3 ny-k3w-pth (77) - Murray, *Ancient Egypt* 1917, 63
k3i-pw-r' (143) - Mariette, *Mastabas*, 278
k3i-dbh (153) - Hassan, *Giza V*, fig. 67
ny-sw-qd - Martin, *Hetepka*, pl. 24 (26)
k3i-m-'nh - Giza tomb G7211, unpublished
k3i-sšmw - Moussa-Altenmüller, *MDAIK* 36 (1980), 331
- 4 ph-r-nfr (46) - Junker, *op. cit.*, 64 (1)
prni-'nhw - Petrie, *Gizeh and Rifeh*, pl VII A
- 5 ph-r-nfr (46) - Junker, *op. cit.*, 64 (2)
nfw - Statue Boston Museum of Fine Arts 31.777, unpublished
k3i-m-'nh - as 3
sd3fw - Headrest in Giza tomb G7215u, unpublished
k3i-m-'nh - Junker, *Giza IV*, Abb. 6
tnti - Baumgartel, *JARCE* 7 (1968), pl. XI (fig.'22)
- 6 msdrw - Fischer, *Offerings*, n. 25, fig. 9
- 7 nfw - as 5
- 8 nfw - as 5; tnti - Giza tomb G7946, unpublished
k3i-m-'nh - Junker, *op. cit.*, Abb. 7
- 9 ny-k3w-pth (77) - as 3; k3i-pw-r' (143) - as 3
k3i-dbh (153) - as 3
ny-s'nh-3ht; iti (73) - Hassan, *Giza III*, fig. 107 (?)
3ht-htp - Hassan, *Giza I*, fig. 136
'nh-h3f - *BM Stelae I²*, pl. XV (7)
iy-mry - Junker, *Giza X*, Abb. 53

continued

Table 27 continued

- 10 **k3i-m-qdi** - Cairo, CG 68
3ht-htp - Hassan, *op. cit.*, fig. 133
pth-nb-nfrt - Junker, Giza VI, Abb. 91; **'nh-h3f** - as 9
wri - Junker, *op. cit.*, Abb. 72
k3i-m-'nh - *id.*, Giza IV, Abb. 10 (B)
- 11 **iy-mry** - as 9
- 12 **htpi** - Quibell, *Excav. Saqq.* (1906-07), pl. VI (2)
- 13 **izi** (18) - Pierret, *Receuil des inscriptions du Louvre* II, 76
htpi - as 12
- 14, 15 **izi** (18) - as 13

hd, **shd iry-ht pr-hd** is regularly found; if the titles on the architrave read from right to left in descending order, then we also have the sequence **shd pr-hd**, **zš pr-hd**, **shd iry-ht pr-hd**.¹ On the statues of **tnti** and **nfw** in the Museum of Fine Arts, Boston the following sequences are found: statue 31.776 gives **shd pr-hd**, **shd iry-ht pr-hd**, while statue 31.777 bears **shd iry-ht pr-hd**, **nht-hrw pr-hd**.² Finally, on the false door of **k3i-pw-r'** (143) is found **shd zš pr-hd**, **imy-ht pr-hd**, **imy-r pr-hd hnw**.³ One wonders whether these titles of **k3i-pw-r'** are not in fact written in reverse order, especially as the title **hm-ntr nfr-izzi** (perhaps the most prestigious one he held) appears at the end of the string.

After conflating the above titles, it is impossible to link the resulting sequences **shd pr-hd**, **zš pr-hd**, **shd iry-ht pr-hd**, **iry-ht pr-hd** and **imy-r pr-hd hnw**, **imy-ht pr-hd**, **shd zš pr-hd** as no officials have **shd pr-hd** and (for example) **shd zš pr-hd** together. From this it seems that the types of titulary divide into two groups by this sequence, the second selection of titles generally being held by the more important officials, and the first by the lesser ones.

There is an interesting division in location of the tombs of these men. Most of the overseers of the (two) treasuries after the early fifth dynasty were buried at Saqqara (exceptions, **k3i-dbhn** (153), **'nh-h3f**; **q3r** (35) and his son **ny-s'nh-3ht**; **iti** (73)), while the majority of officials named in table 27 were buried at Giza. This again emphasises that the more important officials were generally buried at Saqqara.

We conclude from the titles above that, not surprisingly, scribal offices were the most frequent in the administration of the treasury, with **shd pr-hd** and **zš pr-hd** being the most common. There were doubtless other positions in the department, but either by chance of preservation or insufficient status for an elaborate burial, evidence of them has not survived.

1 Junker, Giza IV, first sequences on Abb. 6.

2 From tomb Giza G7946, see *PM* 32, 207.

3 Mariette, *Mastabas*, 278-9.

Conclusions

The writing of the titles **imy-r pr-ḥd** and **imy-r prwy-ḥd** provides some useful palaeographic dating criteria, as the form of the **pr-ḥd** group changes in the later fifth dynasty.

Holders of **imy-r pr-ḥd** are normally officials who held other titles in the treasury and related institutions. They are generally not of the highest rank, and this title is never held by viziers. It exists from the beginning of the fourth dynasty to the beginning of the sixth. **imy-r prwy-ḥd** appears only sporadically with non-viziers in the fourth and fifth dynasties, but there are a number of such holders, both memphite and provincial, in the sixth dynasty. Only a few holders of this title show other links with the treasury, sometimes in the form of tenure of **imy-r pr-ḥd**.

Many viziers held **imy-r prwy-ḥd** from the mid-fifth dynasty onwards. It is evident that from this time at least there was a minimum of two and perhaps even three contemporary holders of the two senior treasury titles. There was thus a division of responsibility, and some memphite officials probably dealt with revenues in the provinces until some local nomarchs were granted the title of **imy-r prwy-ḥd**, when a corresponding drop in the number of memphite holders of the latter title is found.

Little evidence survives as to the exact function of the treasury in the Old Kingdom. Scribes of the treasury occasionally appear in private tombs, perhaps reckoning state revenue on private estates, although they could also be part of the administration of the same. The treasury may have provided a part of the funerary offerings or equipment of the deceased. There is very little evidence of the extent of treasuries outside the principal state one(s): they may have existed in institutions such as temples, and possibly on private estates. The evidence from titles connected with the treasury below the rank of overseer shows that the majority of offices were scribal and associated with reckoning.

The Old Kingdom supplies no evidence at all of the role of the treasury in the economic life of Egypt, with the exception that certain commodities, such as metals, linen, wine and possibly oils, were controlled by it in particular contexts. One must then assume that as an institution it was concerned with the supervision of central government expenditure, and the assessment of dues from various institutions and individuals. As Egypt had a non-money or redistributive economy, such dues as had to be paid would have been most frequently in the form of produce, and paramount among this must have been grain. Parallels between the titles **imy-r šnwt/imy-r šnwtj** and **imy-r pr-ḥd/imy-r prwy-ḥd** have been noted where they occur, and it will be seen below in chapter 8 how the two institutions are linked in the titularies of viziers. A similar organisation of these two institutions is thus very likely, as is the possibility that between them (together with other less significant departments such as the **pr-'ḥ3w** and the **izwy n ḥkr nzw**) they formed that part of the administration concerned with the economic management of the country.

8 The Viziers

General

It has long been realised that the title of **t3yty z3b t3ty** represents the highest administrative office in Ancient Egypt at almost all periods.¹ Alone among the group of titles forming the subject of this study, it is regularly translated by a term from a far-removed period of history, namely 'Vizier'.² The word 'Vizier' originally refers to the senior minister in a moslem country, especially to the 'Grand Vizier', the chief minister of the Sultan of Turkey; this term expresses the wide scope of the responsibilities of the ancient title as it cannot be associated with any specific functions as can, for instance, that of overseer of works. Table 28 is a list of holders of this title in the Old Kingdom.

t3yty z3b t3ty seems to be the oldest of the group of titles studied in this work. The first certain occurrence of it in Egyptian history may antedate the Step Pyramid at Saqqara, as it was written on stone vessels found in the galleries beneath that monument, and was held by a man named **mn-k3**.³ No certain further examples of it are however attested before **nfr-m3't** (86) at the beginning of the fourth dynasty. For other different early forms of **t3yty z3b t3ty**, see below page 335.

Several occurrences of the title have been excluded from table 28 as the identities of the holders are not certain. A vizier, the first letter of whose name is **p** (surely a **pth-htp**), is referred to in the Abusir Papyri.⁴ **wni** twice mentions a vizier in his biography without giving the name.⁵ Similarly, the letter to the

-
- 1 This first seems to have been noted in an Egyptian context by Brugsch (*Hieroglyphisch-Demotisches Wörterbuch* VII, 1307).
 - 2 Term perhaps first used in this context by Meyer, *Geschichte des alten Agyptens* (1887), 62.
 - 3 Lauer, *Pyramide à Degrés* V, pl. I.
 - 4 HPBM, pl. LXIV G; Posener-Kriéger, *ArchAb* II, 590.
 - 5 *Urk.* I, 99.5; 100.15.

Table 28

List of Viziers

A. Memphite:

Sneferu		sšm-nfr III	(131)
		pth-htp	(48)
nfr-m3't	(86)	* r'-špss	(95)
Khufu		Later Djedkare	
'nh-ḥ3f	(34)	pth-htp I	(49)
ḥm-iwnw	(96)	sndm-ib; inti	(120)
Late Khufu-early Khafre		Early Wenis	
k3i-w'b	(140)	3ḥt-htp	(2)
Name Lost	(170)	3ḥt-htp; ḥmi	(3)
ḥ'f-minw	(103)	sndm-ib; mḥi	(121)
nfr-m3't	(85)		
Middle Khafre-Menkaure		Later Wenis	
ḥ'f-ḥwfw	(104)	iḥy	(15)
ny-k3w-r'	(78)	ny-'nh-b3	(70)
iwn-minw	(7)	iy-nfrit; š3nf	(6)
nb-m-3ḥt	(81)		
'nh-m-'-r'	(29)	End fifth-early sixth dynasty	
Menkaure-early fifth dynasty		* pth-htp; tfi	(50)
dw3-n-r'	(161)	ḥnmw-nti	(113)
sš3t-htp; hti	(126)	k3i-gmni; mmi	(151)
b3-b3f	(42)	nfr-sšm-r'; šši	(88)
šm-k3-r'	(125)	Middle Teti-early Pepy I	
Sahure-early Neweserre		'nh-m-'-ḥr; zzi	(30)
		mrrw-k3i; mri	(68)
		ḥnty-k3i; iḥḥi	(109)
* wr-b3w-b3	(39)	mḥw	(69)
w3š-ptḥ; izi	(37)	pth-htp	(51)
* minw-nfr	(55)		
Mid fifth dynasty		Mid-Pepy I - c. year 20 Pepy II	
šm-'nh-ptḥ	(123)	* tp-m-'nh	(155)
k3i	(136)	tnti	(158)
ph-n-wi-k3i	(45)	mry-tti	(63)
pth-špss	(52)	r'-wr	(93)
		mrri	(67)
		nfr-sšm-sš3t; ḥnw	(89)
Early to middle Djedkare		zzi	(114)
		idw I; nfr	(22)
pth-htp dšr	(47)	'nh-mry-r'	(33)

Table 28 continued

Middle Pepy II		h'-b3w-hnmw; biw	(102)
		ny-hb-sd-nfr-k3-r'	(72)
* hnw	(108)		
* ihy-hnt	(16)	End Old Kingdom or later	
k3i-htp	(149)		
mry-r'-i3m	(61)	wr-k3w-b3; ikw	(40)
mry-r'-mry-'nh-ptḥ	(62)	tti	(156)
s3bw-ptḥ; ibbi	(117)	k3i-nfr	(148)
šn'y	(133)	ttw	(160)
Later Pepy II			
	nb-k3w-hr; idw		(82)

* indicates vizierial titulary certainly incomplete

B. Provincial:

Late fifth dynasty

hrwy I	Akhmim ¹
hrwy II	Akhmim ²

Teti

izi	Edfu ³
------------	-------------------

Perhaps Pepy I

iww	Abydos ⁴
------------	---------------------

Early Pepy II

d'w	Abydos ⁵
idi	Abydos ⁶

- 1 Newberry, *AAA* 4 (1912), 112 (19); dating, Kanawati, *Governmental Reforms*, 3.
- 2 Newberry, *op. cit.*, 105 (7); this man could be a son of the above.
- 3 Alliot, *Rapport sur les Fouilles de Tell Edfou* (1933), 22-7; date, Baer, *Rank and Title*, 60 (62).
- 4 Cairo, *CG* 1576, *LD Text II*, 176 (5); date, Kanawati, *op. cit.*, 33.
- 5 Cairo, *CG* 1431; also mentioned in royal decrees, *Urk.* I, 279.18, 280.15; date, Baer, *op. cit.*, 156-7 (591).
- 6 A variety of monuments: Baer, *op. cit.*, 61-2 (73a); also Fischer, *AJA* 66 (1962), 65-9; date, see *ihy-hnt* (16).

Table 28 continued

Middle Pepy II

ppy-nbt	Abydos ¹
'nh-ppy hry-ib	Meir ²

Late Pepy II

'nh-ppy hny-km	Meir ³
sm ³ i	Koptos ⁴
idi	Koptos ⁵



End Old Kingdom and later

hm-r'; izi	Deir el Gebrawi ⁶
hnqr; iy...f	Deir el Gebrawi ⁷

vizier published by Gunn does not name the addressee.⁸ The biography of s³bni of Aswan mentions a vizier, but his name, if it had ever been present, is damaged.⁹

It appears from the stela of hwi and nbt from Abydos that nbt, the mother-in-law of Pepy I, also held this title, although it is likely that it was not in a full administrative capacity.¹⁰ Also from the reign of Pepy I comes the mention of the vizier in the Dahshur decree of that king.¹¹ This occurrence is also omitted as it is probable that this vizier was r'-wr (93).¹²



- 1 Cairo, CG 1573; date, Baer, *op. cit.*, 71 (135), Kanawati, *op. cit.*, 89.
- 2 Blackman, Meir IV, *passim*; date, Baer, *op. cit.*, 70 (133).
- 3 Blackman, Meir V, 16-56; date, Baer, *op. cit.*, 70 (134).
- 4 Mentioned in royal decrees, Urk. I, 295-304; date, Kanawati, *op. cit.*, 112-4.
- 5 Mentioned in royal decrees, Urk. I, 299-306; date, Kanawati, *loc. cit.*
- 6 Davies, Deir el Gebrawi II, pl. XVII-XX; date, Kanawati, *op. cit.*, 117.
- 7 Davies, *op. cit.*, pl. XXIII-XXVI; date, Kanawati, *loc. cit.*
- 8 ASAE 25 (1925), 248, pl. I a (line 3).
- 9 Urk. I, 140.4.
- 10 Cairo, CG 1578; see Kanawati, *Governmental Reforms*, 31, for the view that she held it in an administrative capacity. Perhaps in reality her husband hwi exercised the powers, while she held it in an honorific fashion (Fischer, *Varia*, 74-5).
- 11 Borchardt, ZAS 42 (1905), pl. I.
- 12 The tomb of a vizier s³sm-nfr, perhaps of the reign of Pepy I, has been discovered recently in the Teti Pyramid Cemetery at

The writing of the title **t3yty z3b t3ty** in the Old Kingdom is composed of three separate elements:  **t3yty**, perhaps 'he of the door/curtain',¹  **z3b**, perhaps 'judge' or at least a legal official, and  **t3ty**, which is used alone in the Middle Kingdom and later to signify 'vizier'. That the last element is the principal one is clear from the fact that it is never omitted in the Old Kingdom, and becomes the normal writing in later periods, usually with the addition of a phonetic complement and stroke -

 . The **t3yty z3b** elements are also found in the New King-

dom but are not as common as **t3ty** alone, whereas the three elements together form the normal Old Kingdom writing. It is very likely that these were originally construed as two or three separate titles, but for the Old Kingdom and much of the Middle Kingdom were regarded as one coherent entity.²

More detailed examination of the writing of **t3yty z3b t3ty** presents a few noteworthy aspects. Where the vizier is referred to outside strings of titles in tombs, the title is usually written with a seated man determinative. Perhaps in a funerary context, the large figures of the deceased in the scenes acted as determinatives.³ Turning to more detailed matters, we can observe the appearance of small protrusions on either side of the frieze of

uraei on the **t3yty** sign ( as against ). It is evi-

dent that the more complex form of this hieroglyph did not appear before the later fifth dynasty. The earliest examples appear in the reign of Wenis (**3ht-htp** (2), **3ht-htp; hmi** (3) and **sndm-ib; mhi** (121)).⁴ In fact, the tomb of **3ht-htp** contains both the older and

newer writings,⁵ suggesting that the form  was not then fully

Saqqara, although no details of his titulary are available (cf. Kanawati, *Excavations at Saqqara* I, 9). Helck refers to a vizier as 'Berlin 1187' (*Beamtentitel*, 56 n. 11); it has not yet proved possible to locate this monument.

1 cf. Spencer, *The Egyptian Temple*, 211-2.

2 cf. Sethe, *ZAS* 28 (1890), 43; Helck, *op. cit.*, 56.

3 This is certainly true for the writing of the name of the deceased, Fischer, *MMJ* 8 (1973), 7.





4 Respectively, Davies, *Ptahhetep and Akhethetep* II, pl. VI; Hassan, *Saqqara* I, pl. XXVII A; LD II, 75.

5 The older writing appears on Davies, *op. cit.*, pl. XIV; two different forms of the **pr-hd** group were also found in this tomb, suggesting that the forms of a number of signs were changing at the same period.

established. Some examples from the later sixth dynasty do not exhibit these protrusions; this may in some cases be due to the poor quality of the work involved and does not necessarily imply a reversion to the older form. These protrusions seem to have developed as time went on, becoming  in later periods.¹ Some Old

Kingdom writings in fact suggest that these protrusions may originally have been extensions of the first and last elements of the frieze of uraei on top of the sign, which later became part of the outer frame (for example, that of **k3i-gmni** (151)).² The number of these uraei in the frieze seems to vary between four (**h'f-hwfw** (104) for example) and seven (**3ht-htp** (2)), but this scarcely seems consistent by date.³ That of **h'-b3w-hnmw; biw** (102) omits the frieze completely, doubtless to avoid the presence of potentially hostile creatures in the burial chamber, while that of **sndm-ib; mhi** (121) is composed of two facing sub-groups of four uraei.⁴

The forms of the **z3b** and **t3ty** elements do not generally call for comment. However it is a feature of some fourth and early fifth dynasty examples to add a phallus to the normal group of signs that

write the title -     . This addition is doubt-

less due to the associations of **t3ty** with the word **t3y**, 'male'.⁵ The extra sign is not very common, and it disappeared at about the same time as did the titles of king's sons from the titularies of viziers, that is about the reign of Neferirkare.

There are three very unusual writings. The first is that of **mrr** (67) with the central element as  .⁶ This is perhaps

due to a confusion with the word **t3y** 'male'. Another explanation is that it was changed to remove the depiction of a potentially dangerous creature from the sarcophagus. The other examples come from the provinces. **izi** of Edfu seems to omit the **t3ty** element;⁷ one is inclined to regard this as an error, as otherwise his titular features titles that are usually found with the vizier in the

provinces. The writing  of **iww** is more unusual, and as such

is the only Old Kingdom illustration of the fact that the **t3ty** element was the most important of the three; from his titular,

1 For example, that of **rh-mi-r'**, Davies, *Rekhmire* II, pl. LXXIV.

2 von Bissing, *Die Mastaba des Gem-ni-kai* II, Taf. V.

3 Respectively, Cairo, CG 46 and Davies, *Ptahhetep and Akhethetep* II, pl. VI.

4 Respectively, Jéquier, *Pepy II III*, pl. 52 and LD II, 75.

5 cf. Sethe, *op. cit.*, 43; Helck, *op. cit.*, 56.

6 Hassan, *Saqqara III*, 36-7; comment, Fischer, *JEA* 65 (1979), 181 (p. 26).

7 Alliot, *Rapport sur les fouilles de Tell Edfou* (1933), 24.

t3yty z3b t3ty was clearly meant.¹

The Titularies of the Viziers

A. Summary of Results from Previous Chapters

Chapters 3-7 have each devoted a short space to the extent to which viziers held either the principal title with which each chapter was concerned or subordinate ones in each particular administrative area. Chapter 3 showed that, while **imy-r ḥwt wrt 6** was only held by the vizier, these holders did not necessarily hold many other legal titles. A number of viziers did hold legal titles, but they were not necessarily those who also held **imy-r ḥwt wrt 6**; the total was not sufficiently high for it to be apparent that such a career was instrumental for later promotion to the vizierate and **imy-r ḥwt wrt 6**. Occurrences of legal titles can in some instances be traced to earlier tenure of the title **imy-r ḥwt wrt**.

Chapter 4 concluded that viziers holding **imy-r žš 'nzwt** held fewer titles of a scribal nature than did their non-vizierial fellows. When compared to the viziers who did not hold **imy-r žš 'nzwt** however, it was seen that the latter held far fewer scribal titles. Overall, the number of such titles held by all viziers is not very remarkable, and again does not form a particularly significant feature of their titularies. Tenure of **imy-r žš 'nzwt** by a vizier does not necessarily presuppose a pre-vizierial scribal career.

Some pre-vizierial involvement in a related area is evident from study of the viziers who were overseers of works (Chapter 5). This was principally confined to members of the **sndm-ib** family, the viziers of whom (**sndm-ib 's inti** and **mḥi, hnmw-nti, impy** and **s3bw-ptḥ**) probably held **imy-r k3t nbt nt nzwt** before their final promotions. Further viziers are attested as holding the same office before their promotion. Others did hold labour-related titles, and indeed were not always those who were overseers of works. Again, tenure of this title by a vizier does not necessarily indicate pre-vizierial tenure of titles relating to the office of overseer of works. Of the different forms of overseer of works titles found, only that of **imy-r k3t nbt (nt) nzwt** seems to occur in the titularies of viziers.

No subordinate granary titles may be found in vizierial titularies, and it is evident that the involvement of viziers with that institution was solely with the title **imy-r šnwty**; there is very little evidence of the extent to which viziers held this title before their promotion (chapter 6).

In similar vein, **imy-r prwy-ḥd** is found with viziers, but there are in their titularies no subordinate titles specifically mentioning the treasuries (chapter 7). Titles with **hkr nzwt** are the only ones to appear frequently in the titularies of viziers that attest any association with the treasury, and they are very closely related to the appearance of **imy-r prwy-ḥd**. It is vir-

1 LD Text I, 176 (5); the writing on Cairo, CG 1576 is normal.

tually impossible to tell whether any viziers were overseers of the treasuries or held titles with **hkr nzw**t before their promotion.

Thus subordinate titles in the areas of scribal and legal administration and the organisation of labour are found with moderate frequency in the titularies of viziers, but those associated with the granary and treasury are not.

B. Other Principal Title Groups

1. Honorific Titles

A cursory examination of the titles of viziers reveals the remarkable number of honorific titles that they held. With many of these titles it is impossible to be totally sure whether they should be classed as 'honorific' or 'religious' titles; in all cases however, it is unlikely that they involved more than a ritual or courtly function, and their multiplication in number probably served both to enhance the status of the individual and, at least where they refer to particular benefices such as cults, to increase his income. For the present purposes those titles which have no obvious religious associations will be considered here.

The most frequent ones are also the most well-known, principally **iry p't**, **h3ty-**, **smr w'ty**, **sd3wty bity** and **hry-tp nzw**t. The distribution of these among the viziers is given in columns 1-5 of table 29, and in relation to the total number of holders in table 30.

iry p't is found most consistently before the reign of Neferirkare or thereabouts, being held by every vizier from the early fourth dynasty onwards (**nfr-m3't** to **sh̄m-k3-r'**). Comparison of columns 1 and 6 of table 29 shows this to be closely related to the presence of a **z3 nzw**t title.¹ There are no holders of **iry p't** from the reign of Neferirkare to that of Djedkare (**wr-b3w-b3** to **pth-šps**), showing that the rank of the vizier was reduced, and one may speculate that this may in part have been a reaction against the practice of the previous period when the vizier came from the family of the king. From the reign of Djedkare to perhaps some point in that of Pepy I, most viziers were again **iry p't** (**pth-htp dšr** to **mrr**i). A general increase in rank may have been one of the changes introduced by Djedkare (others were, for example, the ending of construction of sun-temples and the establishment of a vizier in the provinces). No viziers with **iry p't**, with the exception of **ihy-ht**t and **mry-r'-i3m**, appear from the later part of the reign of Pepy I until some point in the second half of the reign of Pepy II, although one wonders whether this is not in some cases due simply to the non-preservation of this title, especially as it was held with one exception by all the provincial viziers at this time (see table 30). Most of the viziers at the end of the sixth dynasty and after that to the end of the Old Kingdom were again **iry p't**.

1 cf. Schmitz, *Königsohn*, 328.

Table 29

Principal Titles of Memphite Viziers

	1	2	3	4	5	6	7	8	9	10	11	12	13	14	15	16	17
nfr-m3't (86)	X	X		X		X			X					X			
'nh-h3f (34)	X	X		X		X			X					X	X		
hm-iwrw (96)	X	X	X	X		X			X					X			
k3i-w'b (140)	X	X	X			X								X	X		
Name Lost (170)	X	X				(X)			X					X	X		
h'f-minw (103)	X	X	X			X			X					X			
nfr-m3't (85)	X	X	X	X		X								X			
h'f-hmfw (104)	X			X		X								X			
ny-k3w-r' (78)	X	X	X	X		X								X	X		
iwn-minw (7)	X		X	X		X								X			
nb-m-3ht (81)	X		X			X								X			
'nh-m'-r' (29)	X	X		X		X											
dw3-n-r' (161)	X	X				X								X	X		
ss3t-htp (126)	X					X			X								X
b3-b3f (42)	X	X	X			X			X					X	X		
sh̄m-k3-r' (125)	X	X	X	X		X											X
wr-b3w-b3 (39)																	
w3š-pt̄h (37)		X	X		X			X	X								X
minw-nfr (55)									X								
sh̄m-'nh-pt̄h (123)		X	X	X	X			X	X								
k3i (136)					X		X	X	X		X	X					
ph-n-wi-k3i (45)		X		X	X			X	X	X	X	X					
pt̄h-špss (52)		X	X			X			X								X
pt̄h-htp dšr (47)	X	X					X	X	X								
sšm-nfr III (131)		X	X			X			X			X					
pt̄h-htp (48)	X	X					X	X	X	X	X						
r'-špss (95)								X									
pt̄h-htp I (49)	X	X	X	X				X	X	X	X	X					
sndm-ib; inti	X	X	X		X		X	X	X	X	X	X					
3ht-htp (2)			X		X			X	X	X			X			X	X
3ht-htp; hmi (3)	X	X	X	X				X	X	X						X	
sndm-ib; m̄hi	X	X	X		X			X	X	X							
ihy (15)	X	X	X		X			X	X	X	X						

continued

Key to Columns:

1	iry p't	2	h3ty-'
3	smr w'ty	4	sd3wty bity
5	hry-tp nzw̄t	6	Titles of king's son
7	imy-r hwt wr̄t 6	8	imy-r zš ' nzw̄t
9	imy-r k3t nbt (nt) nzw̄t	10	imy-r šnw̄ty
11	imy-r prwy-hd	12	Titles with wd(t)-mdw
13	imy-r šm'w	14	wr 5 pr dhwt̄y
15	'3 dw3w	16	sh̄d hm-ntr̄ of a pyramid
17	imy-r niwt of a pyramid		

Table 29 continued

	1	2	3	4	5	6	7	8	9	10	11	12	13	14	15	16	17
ny-'nh-b3 (70)	X		X												X		
iy-nfrt (6)		X	X		X			X			X						
pth-htp II (50)																	
hrmw-nti (113)	X	X	X		X		X	X	X	X	X	X					X
k3i-gmni (151)	X	X	X	X			X	X	X	X	X	X	X				X
nfr-s3m-r' (88)	X	X	X		X		X	X	X	X	X	X	X				X
'nh-m-'-hr (30)	X	X			X		X	X	X	X	X	X					X
mrrw-k3i (68)	X	X	X	X			X	X	X	X	X	X		X	X	X	X
hnty-k3i (109)	X	X	X	X	X			X	X	X	X	X					X
nhw (69)	X	X	X	X	X			X	X		X	X	X				X
pth-htp (51)								X	X		X	X					
tp-m-'nh (155)			X	X													
nti (158)		X	X	X													
mry-tti (63)	X	X	X	X		X	X	X	X						X	X	
r'-wr (93)	X	X	X	X										X			
mrr (67)	X	X	X	X			X	X	X	X	X		X				X
nfr-s3m-s3t (89)	X	X	X	X	X	X	X	X	X	X							
zzi (114)	X	X												X			X
idw I; nfr (22)					X			X	X	X	X	X					
'nh-mry-r' (33)		X	X	X				X	X	X	X	X					X
hnw (108)																	
ihy-hnt (16)	X	X															
k3i-htp (149)		X	X	X													X
mry-r'-i3m (61)	X	X															X
impy (62)			X	X	X				X	X							
s3bw-ptb (117)		X	X	X	X				X								
sn'y (133)	X	X		X									X				
nb-k3w-hr (82)		X	X	X	X	X	X			X			X				
h'-b3w-hrmw	X	X	X	X			X		X	X	X		X				
ny-hbsd-nfr-k3-r'	X	X	X	X				X			X						X
wr-k3w-b3 (40)																	
tti (156)	X	X	X	X		X		X		X	X				X		X
k3i-nfr (148)	X	X	X	X	X	X						X		X			
ttw (160)	X	X	X	X	X		X		X	X	X			X	X	X	

Key to Columns:

- 1 iry p't
- 3 smr w'ty
- 5 hry-tp nzwt
- 7 imy-r hwt wrt 6
- 9 imy-r k3t nbt (nt) nzwt
- 11 imy-r prwy-hd
- 13 imy-r sm'w
- 15 '3 dw3w
- 17 imy-r niwt of a pyramid

- 2 h3ty-'
- 4 sd3wty bity
- 6 Titles of king's son
- 8 imy-r z3 ' nzwt
- 10 imy-r snwty
- 12 Titles with wd(t)-mdw
- 14 wr 5 pr dhwty
- 16 shd hm-ntr of a pyramid

Table 30

Frequency of the more important Honorific Titles

Title	1	2	3	4	5	6
iry p't	96	68	28	55	43	12
ḥ3ty-'	142	108	34	64	51	13
smr w'ty	322	232	90	56	44	12
sd3wty bity	136	85	51	37	32	5
hry-tp nzwt	144	119	25	25	21	4
rḥ nzwt	473	452	21	0	0	0
mniw nḥn	40	30	10	22	19	3
hry-tp nḥb	51	40	11	21	18	3
imy-iz	26	17	9	15	12	3
smsw snwt	24	16	8	15	12	3
r p nb	25	22	3	13	12	1
im3-'	20	17	3	12	12	0
imy-iz nḥn	16	16	0	11	11	0

Key to Columns:

- 1 Total Old Kingdom holders
- 2 Total memphite holders
- 3 Total provincial holders
- 4 Total viziers with the title
- 5 Total memphite viziers with the title
- 6 Total provincial viziers with the title

Figures in columns 1-3 are approximate

The spread of vizierial holders of the titles ḥ3ty-' and smr w'ty is much less noteworthy, being reasonably consistent at all times.

sd3wty bity appears most frequently in the fourth dynasty and from the beginning of the sixth onwards. Why it should be so sporadic in the fifth is unclear, unless it be due to its being reserved principally for men granted the highest rank, as in most cases it appears with holders of iry p't. Otherwise it is usually found alongside ḥ3ty-' or smr w'ty (or both).

The pattern of occurrence of hry-tp nzwt is different from the above. It is a lower-ranking title than smr w'ty, and has featured prominently in the discussions of the titularies of non-viziers above, where it was most frequently found among the titles of scribes and legal officials (see table 8). These types of title are uncommon in the titularies of viziers in the fourth and later sixth dynasties, and there is a corresponding lack of hry-tp nzwt in these periods. One wonders then whether this title is not in some manner related to features of the career of a vizier in the period before he was promoted, as it bears no relation to the other

common vizierial honorifics. It is also possible that the rank of the vizier was lower in the fifth dynasty, for which compare the non-appearance of **iry p't** noted above.

Two viziers, **k3i** and **idw I**, apparently bear no honorific titles other than **hry-tp nzw**. Particularly in the case of **idw** it is possible that damage to their tombs has caused evidence of higher honorific titles to be lost. This is a more likely explanation than to postulate a special group of viziers who were not elevated to the rank of their fellows, especially as these two officials date to widely separated periods (but for **k3i** see further below page 320).

The title of **rh nzw** never appears in vizierial titularies. This is hardly surprising, as it is by far the lowest-ranking of the group of honorifics in table 30 during the Old Kingdom. Viziers were clearly a consistently very high-ranking group of officials, and hence the lack of **rh nzw** and the comparative rarity of **hry-tp nzw** compared with **iry p't**, **h3ty-** and **smr w'ty**. This may be illustrated by the presence of the title **rh nzw** in the pre-vizierial titulary of **s3t-htp; hti** and its absence from his titles as vizier.

A multitude of less frequent honorific titles is found, the most common of which are **mniw nhn**, **hry-tp nhb**, **smsw snwt**, **r p nb**, **im3-**, **imy-iz** and **imy-iz nhn** (see table 30).¹ In comparison with the first group these are numerically not very significant; however, their occurrences in the titularies of viziers is very marked when compared with those officials discussed in the previous chapters. Viziers form the major portion of the holders of these less frequent titles, notably of **imy-iz**, **smsw snwt**, **r p nb**, **im3-** and **imy-iz nhn**. While these titles were not reserved solely for the vizier, it is clear that they were otherwise granted only to very important or favoured officials, as a feature common to the titularies of all holders of this group of titles is the rank of at least **smr w'ty** and not infrequently that of **h3ty-** and **iry p't**. Holders of one of these less frequent honorific titles usually also bear at least one of the others. The titles **hry-tp nhb**, **mniw nhn** and **imy-iz (nhn)** often occur together. A change is evident in the pattern of tenure of this trio of titles in that the only men to hold more than one of them before the end of the fifth dynasty are viziers, but in the sixth the spread becomes wider, and the holders are principally provincial officials.

The following viziers had large numbers of infrequent and indeed rare honorific titles: **dw3-n-r'**, **b3-b3f**, **w3š-ptḥ**, **ptḥ-špss**, **3ḥt-htp; ḥmi**, **k3i-gmni**, **mrrw-k3i**, **hnty-k3i**, **mhw**, **mry-tti**, **d'w** (Abydos), **'nh-ppy hry-ib** (Meir), **h'-b3w-hnmw**, **tti**, **k3i-nfr** and **ttw**. Why these viziers should have had so many honorific titles may only be guessed at. If we assume that one's basic rank in Ancient Egypt was provided by the more common titles such as **iry p't** and **h3ty-**, then the granting of other rarer titles with presumably 'courtly' functions may have to some extent been due to the level of the indiv-

1 Discussion of functions and origins of some of these, Helck, *Beamtentitel*, 22-3, 30, 38.

idual's favour with the king. There is also clearly a bias in these long titularies towards sixth dynasty men, in part because of the appearance of some extra honorifics at the end of the fifth dynasty, such as *im3-*, *hrp i3ts km* and *hq3 b3t*, but also due to the re-appearance of a number of older titles.¹

The honorific content of vizierial titularies is generally less complex and smaller for most of the fourth and fifth dynasties. There are many titles distinctive of the earlier part of the period which do not recur later, although several of these are religious in nature (see below). Others that disappear in the fifth dynasty are *smr* and *hrp 'h*, the ritual significance of which can be to some extent ascertained.² *hrp 'h* is one of several titles, the meaning of which can be associated with a function, although it seems that by the fourth dynasty it had become another mark of honour and rank. Other similar titles are *hry-wdb m hwt 'nh*, *hry-s3t3 n pr-dw3t* and *'d-mr dw3-hr-hnty-pt*, which were originally doubtless associated with the personal service of the king and his lands.³ Although more common in the titularies of viziers than in those of officials treated in earlier chapters, viziers do not represent a significant proportion of the holders of these titles; they were frequently held by officials whose titularies consist principally of honorific titles such as those who must have formed a sort of 'court' of men favoured by the king, but without any important administrative office.⁴

2. Titles of 'King's Son'

Column 6 of table 29 shows that all viziers from the beginning of the fourth dynasty to about the reign of Sahure held the title of king's son. These men were either true members of the royal family or 'titular princes'.⁵ Most fall into the former category; *hm-iwnw*, *nfr-m3't* (85), *dw3-n-r'*, *s3t-htp*; *hti* and *b3-b3f* belong to the latter. Of these men, the first two were probably related to the royal family, as *hm-iwnw* was almost certainly the son of *nfr-m3't* of Meydum (a son or brother of Sneferu), while *nfr-m3't* of Giza was a son of *nfrt-k3w* (daughter of Sneferu); the descent of the others is unknown, although *b3-b3f* was perhaps the son of *dw3-n-r'*.

These titular princes date only from the end of the fourth dynasty and the beginning of the fifth. Schmitz is probably correct to see in this a connection with changes in the nature of the Egyptian kingship.⁶ The logical next development from this was to exclude king's sons from the senior administrative offices of the

1 Helck, *op. cit.*, 111 ff.

2 *id.*, *ib.*, 24-5, 32-3.

3 *id.*, *ib.*, 68.

4 Some examples: *dbhn* (PM 32, 235-6), *ny-k3-nzwt I* (PM 32, 78-9), *ztw* (PM 32, 135-6), *nn-hft-k3i* (PM 32, 580-1), *tp-m-'nh* (PM 32, 343-4), *k3i-m-rhw* (PM 32, 690), *hnmw-htp* (PM 32, 578-9).

5 Schmitz, *Königssohn*, 84.

6 *op. cit.*, 166.

land, a process completed by the reign of Sahure. Schmitz would prefer to place the active lives of these last king's sons at the end of the fourth dynasty.¹ However, the number of viziers and other high officials known who were king's sons was surely too great for all to have been active in the fourth dynasty, and there is a corresponding lack of viziers who were not king's sons in the early fifth dynasty; a more logical solution would be, at the beginning of the fifth dynasty, for all the king's sons who were already in high administrative positions to be allowed to act out the remainder of their careers, but to appoint no further such officials. One is discussing a period here of no more than twenty years for this change to have been completed.

The remaining king's sons who were also viziers are seven in number. **sšm-nfr** III acquired the title of **z3 nzwt n ht.f** with his promotion to the vizierate; this must have been due to royal favour, and perhaps is an example of a resurgence of the use of **z3 nzwt** titles in the reign of Djedkare.² The viziers in the sixth dynasty are the only king's sons of that period to hold administrative office;³ as such this title must have been an indication of the special favour granted by the king to some of his viziers, rather than an indication of royal birth.

3. High Administrative Offices

Tenure by viziers of the other titles forming the subject of this study will be found in columns 7-11 of table 29. The only such title found before the reign of Neferirkare is **imy-r k3t nbt (nt) nzwt**. This is held by nearly all viziers in the early part of the fourth dynasty, disappears, and then reappears at the end of that dynasty in the titularies of **sš3t-htp** and **b3-b3f**. These two were the first viziers of certain non-royal descent; by analogy, **dw3-n-r'** of the same group may have held this title, which has perhaps been lost as a result of the damage suffered by his tomb. Clearly, the office of **imy-r k3t nbt (nt) nzwt** was not again given to true royal viziers; the non-royal viziers above were complemented by several non-viziers who held this title at that time. This was conceivably the beginning of the removal of the royal family from high offices by permitting them to hold the vizierate alone.

The period from the reign of Neferirkare to that of Neweserre saw the first appearances of the remaining high administrative offices studied here in the titularies of viziers, although **imy-r prwy-hd** had previously been found with a non-vizier. The remainder of this discussion will concentrate on this period and later. From **w3š-pth**; izi onwards, **imy-r hwt wrt 6** occurs sixteen times, **imy-r zš ' nzwt** twenty-nine times, **imy-r k3t nbt (nt) nzwt** twenty-eight times, **imy-r šnwty** twenty-four times and **imy-r prwy-hd** twenty-four times. The similarity between the frequency of **imy-r zš ' nzwt** and **imy-r k3t nbt (nt) nzwt** and also that between **imy-r šnwty** and **imy-r**

1 *op. cit.*, 168.

2 Schmitz, *op. cit.*, 85-6, 168-9.

3 *id.*, *ib.*, 93, 170.

prwy-hd may be coincidental, but it also emphasises the links already noted between these titles. There may have been some association between charge of royal documents and the organisation of labour, and the interdependence of the granaries and treasuries with regard to the collection of income in kind and its consequent (re)distribution is undoubted.

On the basis of the observed close association between offices of scribal and legal natures, such as between **imy-r hwt wrt** and **imy-r zš 'nzw**t in the case of non-viziers, we might expect to find **imy-r hwt wrt 6** and **imy-r zš 'nzw**t held by the same viziers. Columns 7-8 of table 29 show this consistently to be the case until the reign of Pepy II and later. One may hesitantly try to fill the two gaps in the latter reign. It has been suggested above that **imy-r zš md3t** in the tomb of **h'-b3w-hnmw**; **biw** may be an abbreviated writing for **imy-r zš 'nzw**t (page 199), while it is very likely that the titular of **nb-k3w-hr**; **idw** is not complete, and so this title could be restored. It is evident that for most of the Old Kingdom, the supreme juridical office was held by the same man as was in charge of the issuing of royal commands, many of which, it can be imagined, would have been of a legal nature.

Table 29 also shows that for most of the Old Kingdom after the reign of Neferirkare, **imy-r zš 'nzw**t and **imy-r k3t nbt nt nzw**t tended to be held by the same individual. We have suggested various associations between these two administrative areas above, although one suspects that in the case of the viziers both titles tend to appear together simply as an expression of that official's control over major administrative areas.

Again, this table shows that nearly all holders of either **imy-r šnwt**y or **imy-r prwy-hd** (or both) also held **imy-r zš 'nzw**t. These exceptions are almost all viziers for whom partly incomplete titularies have been argued, such as **'nh-m-'-hr**; **zzi**, **nb-k3w-hr** and **h'-b3w-hnmw**.

From this one may conclude that **imy-r zš 'nzw**t stood in a pivotal relationship to all these other titles, in that a vizier who held one of these others would almost certainly have been **imy-r zš 'nzw**t. This was so that as well as being in charge of one of the major areas of the administration he would also have the authority of being in overall charge of the necessary bureaucracy, that is the **'nzw**t, 'royal documents'. Further evidence for this view is that only one vizier appears in table 29 to have held **imy-r zš 'nzw**t as his only high administrative title. Closer examination shows this man to have been **r'-špss**, the exact extent of whose vizierial titular is unclear, and who in fact held **imy-r zš 'nzw**t, **imy-r k3t nbt (nt) nzw**t and **imy-r šnwt**y before his promotion.

The only vizier who cannot be fitted into this scheme is **ttw**, who held all the high titles with the exception of **imy-r zš 'nzw**t. It is not possible to restore this title with ease. One may however argue that this could possibly reflect some administrative change that took place after the end of the sixth dynasty, as no memphite examples of **imy-r zš 'nzw**t are known from that period.

imy-r zš 'nzwt is thus perhaps the most important (or at least essential) element of a vizier's titular after the early fifth

dynasty. This supports the similar conclusion arrived at from the frequency of this title's appearance in places where the vizier is addressed directly by the king, as in letters and decrees (above page 214-15).

Apart from the significance of **imy-r zš ' nzw**, it will be seen from table 29 that the concentration of other high offices on a vizier, which was rather haphazard at first, became a little more regular in the second half of the fifth dynasty, perhaps from the reign of Djedkare or so. This may possibly coincide with the gradual reduction of the number of non-vizierial holders of the titles **imy-r zš ' nzw** and **imy-r k3t nbt (nt) nzw**, and the associated concentration of more offices on fewer individuals.

Much more difficult to explain is the actual selection of titles granted to individual viziers. It has already been shown in the preceding chapters that a vizier's tenure of an office (assuming that the title in question does actually apply to that period in his career) is not necessarily related to the holding of titles in a related field. Some viziers in fact seem to have held no other high administrative titles, such as **tnti**, **ny-'nh-b3** (tomb damaged), **r'-wr**, **k3i-htp**, **mry-r'-i3m** (tomb damaged), **šn'y** (tomb damaged) and **k3i-nfr**. Two possible explanations of this (to be explored further below) are that there were two contemporary viziers in some periods, or that these viziers were complemented by non-viziers holding the particular titles in question.

4. Religious Titles

A very wide range of titles are found which are representative of priestly offices, but many of them are rather rare. The most common are those such as **hry-hb**, **hry-hb hry-tp** and **hrp i3t nbt nrt**. The first title is not unusual with men of the rank **smr w'ty** and above, while the second, being of a higher rank, is most often found in the titularies of very high officials, usually of the rank of **iry p't** and/or **h3ty-'**. Consequently its appearance with viziers is more frequent than with the holders of other administrative titles. **hrp i3t nbt nrt** may have originally been the supreme religious office and, whatever its function during the Old Kingdom, it continued to be held by men of high rank, and is very common with viziers in the fourth dynasty.¹

It is evident that very many religious titles had a great deal in common with the rarer honorifics discussed above. Many of the former titles doubtless served to express the individual's favour with the king,² while many of them served to emphasise a variety of features of the concept of Egyptian kingship.³ Viziers occur very frequently among holders of these titles due to their special position as the senior administrative official and the close relationship with the king that this must have entailed.

1 cf. Helck, *Beamtentitel*, 52.

2 To illustrate this, one may note the mixture of these two types of titles discussed together by Helck, *op. cit.*, 29-44.

3 *id.*, *ib.*, 45-54.

The more exotic religious titles are particularly common at two periods of the Old Kingdom, the fourth to early fifth dynasties and the first half of the sixth. Fourth dynasty officials, and the viziers in particular, exhibit several very distinctive titles, such as **w' m wr(w) zh**, **hm-ntr b3 'npt**, **hm-ntr b3stt**, **hm-ntr šsmtt** and **hm-ntr wnw-r hnty minw**.¹ These and others like them fell into disuse after the early fifth dynasty. The later fifth and early sixth dynasties are marked by a revival of many archaic titles; this is one of several features that changed at this time and, as Helck has noted, is exemplified by the titularies of **k3i-gmni** and **mrrw-k3i**.²

Such changes may be illustrated by the example of the title '3 **dw3w** ( ; column 15 of table 29). This title is found fif-

teen times with viziers out of a total of twenty-five occurrences. Before **w3š-ptḥ; izi** (reign of Neferirkare) it was held exclusively by men with the titles of king's son. The only holders in the middle part of the fifth dynasty are **ptḥ-špss** and **r'-m-k3i**; of these two **r'-m-k3i** was not a vizier but a true king's son,³ while **ptḥ-špss** was married to a daughter of Neweserre. Their relationship to the king thus links them with the earlier holders of this title and separates them from contemporary administrative officials. The title then reappears at the end of the dynasty with both non-viziers (for example, **ḥtp-ḥr-n-ptḥ** (100) with the remarkable archaizing titulary) and viziers, and is found sporadically in the sixth dynasty.

A title of some importance to the study of the vizierate is **wr 5 pr dhwtj**. This title probably represents the chief priesthood of the cult of Thoth, but is important here as it is only found regularly in the titularies of viziers in the fourth and early fifth dynasties.⁴ It reappears in the sixth dynasty, and the form **wr 5** is also found (sometimes with non-viziers) in the second half of that dynasty.⁵

A further pair of titles with religious import which are associated with attendance on the king are **sm** and **hrp šndyt nbt**.⁶ These are found once in the fifth dynasty (**w3š-ptḥ**) and regularly from the early sixth onwards. They are more generally a feature of high-ranking titularies of the later Old Kingdom.

-
- 1 Helck, *op. cit.*, 40-1, 122-3; Junker, *Giza I*, 149; the last one should perhaps be read **hm-ntr wnw-r hnty-hm**, *id.*, *Giza II*, 191.
 - 2 *op. cit.*, 111-2.
 - 3 *PM* 32, 487-8; cf. Schmitz, *Königsson*, 87-8.
 - 4 cf. Sethe, *ZAS* 28 (1890), 44; Helck, *op. cit.*, 56-8.
 - 5 There are three occurrences of this title: the vizier **zzi**, **hrdni** (Jéquier, *Tombeaux*, 111) and **nhri** (*id.*, *Pepy II II*, fig. 62). The titularies of the first and last are so unlike that of **hrdni** that in their cases **wr 5** must be a shortened version of **wr 5 pr dhwtj** and not a title of scribes as Helck suggests (*op. cit.*, 58).
 - 6 Helck, *op. cit.*, 16-18, 35.

5. Titles connected with Royal Institutions

Previous chapters have shown that the majority of such titles occur with lower-ranking officials, and it is only after the changes of the later fifth dynasty that those associated with royal pyramids appear in the titularies of men of higher rank. Considering the rank of the vizier, one would not expect to find any significant occurrences of these titles in their titularies before the reign of Wenis; an absence of sun-temple titles is also rather likely.

These predictions turn out to be very close to the truth. Of the viziers before the later fifth dynasty, **h'f-hwfw** was **hm-ntr hwfw**, probably to be explained by his relationship to that king, and **ph-n-wi-k3i** was **shd w'b w'b-swt-wsr-k3f**, by no means a low-ranking office. The earliest examples of the newer type of priest-hoods are found with **3ht-htp**, who was **shd hm-ntr** of the pyramids of Neweserre, Menkauhor and Djedkare; some of these titles may have been applied retrospectively.¹ With the reign of Teti one finds all the viziers bearing the title **shd hm-ntr dd-swt-tti** (column 16 of table 29). The title of **imy-r niwt mr**, usually not specifying the name of the pyramid, also became part of the vizierial titulary (column 17 of table 29).

The reign of Pepy I saw a continuation of this practice, but it is not so frequent, and many officials other than viziers, especially provincial ones, held one or other of the titles **shd hm-ntr...** or **imy-r niwt mr**. Few viziers bore the office of **shd hm-ntr** of the pyramids of Merenre or Pepy II, holders of this title being largely concerned with administration in the provinces, and **imy-r niwt mr** became the principal pyramid title of the viziers of the reign of Pepy II.² Thus **shd hm-ntr** was effectively replaced in importance by **imy-r niwt mr**. The holders of these titles may as part of their vizierial duties have supervised the activities in the pyramid towns, since the importance of these institutions must have warranted the attention of the highest officials, but it is also likely that it was as much a status-indicator as anything else.

6. Other Titles

Titles incorporating the expression **wd(t)-mdw** often occur in the titularies of the high officials discussed previously. Column 12 of table 29 shows these titles not to be especially frequent with viziers; those who did bear them were generally the holders of a number of other high administrative titles. It would appear that it was not imperative for the vizier, perhaps by virtue of his high rank, to hold such titles which are more common with non-viziers.

The title of **imy-r šm'w** has not previously entered into these discussions.³ It is however held by at least nine memphite viziers

1 Baer, *Rank and Title*, 264-5.

2 cf. Helck, *MDAIK* 15 (1957), 101; Kees, *Vezerat*, 42-3.

3 'Overseer of Upper Egypt' is one of the most intensively studied Old Kingdom titles, for example: Kees, *Provinzialverwaltung*

(column 13 of table 29), and it made its first appearance in the capital, although the majority of its holders are provincial. The earliest holders are **k3i** and **r'-šps**, but it is unknown whether either held this title while vizier (see the Prosopography). The earliest certain holders of this title buried in the provinces belong to the reign of Merenre (for example, **mry-r'-nfr**; **q3r** of Edfu); before that time there were also non-vizierial memphite holders in addition to viziers.¹ After this date however, the only memphite holders were the viziers indicated in table 29. There is no obvious consistent pattern evident in the tenure of this title (but see further below page 325-6).

C. A Comparison of the Titularies of Provincial Viziers

The viziers buried in the provinces form the largest group of extra-memphite officials discussed in this work. In general the patterns of their titles, given in table 31, are very similar to those of the memphite viziers. All viziers with the exception of **'nh-ppy hny-km** of Meir were **iry p't**,² and all were **smr w'ty** except for the second **hrwy** at Akhmim; all were **h3ty-**. In keeping with the majority of their memphite colleagues of similar date, no provincial viziers were king's sons.

The distribution of their high civil administrative titles has been referred to in the preceding chapters. The most common by far is **imy-r zš 'nzw**, and this stresses the association of the title with the vizier, and its consequent central position.³ Of those who held more than one other high administrative title, only **'nh-ppy hny-km** did not possess **imy-r zš 'nzw** and this title may even have been lost from his tomb. The only other offices found on more than one occasion are **imy-r šnwty** and **imy-r prwy-hd**; perhaps that this is due to the concern of these individuals with revenue collection. All provincial viziers from the early or middle part of the reign of Pepy II to the end of the Old Kingdom were **imy-r šm'w**, showing the emphasis on this title in the provinces. Finally, as noted above, **shd hm-ntr** of a royal pyramid is not common after the middle of the sixth dynasty, and is replaced in titularies of viziers (particularly the provincial ones) by **imy-r niwt mr**.

I, 85-98; Helck, **Beamtentitel**, 109-10; Baer, **Rank and Title**, 281-6; Goedicke, **MIO** 4 (1956), 1-10; Fischer, **Dendera**, 94-99; Martin-Pardey, **Provinzialverwaltung, passim**; Kanawati, **Governmental Reforms, passim**.

- 1 **'nh-wnis** (PM 3², 616), **pth-htp** II (50) (it is again unknown whether he continued to hold this title as vizier), and **ny-k3w-izzi** (76).
- 2 For a comment on this see Kanawati, **Governmental Reforms**, 93, also on the surprising distribution of the title **t3yty z3b t3ty** on the walls of this tomb.
- 3 It is possible that **imy-r 'nzw** in the tomb of **hm-r'** at Deir el Gebrawi stands for **imy-r zš 'nzw** (Davies, **Deir el Gebrawi** II, pl. XIX).

Table 31

Principal Titles of Provincial Viziers

	1	2	3	4	5	6	7	8	9	10	11	12	13	14	15	16	17
hrwy I	X	X	X														X
hrwy II	X	X						X									X
izi	X	X	X		X			X									
iww	X	X	X					X			X						X
d'w	X		X	X				X									X
idi	X	X	X	X				X	X			X			X	X	
ppy-nht	X	X	X	X				X	X			X					X
'nh-ppy hry-ib	X	X	X	X	X			X		X		X					
'nh-ppy hny-km			X	X	X	X				X	X	X					
sm3i	X	X	X					X				X					X
idi	X	X	X									X					X
hm-r'; izi	X	X	X		X			(X)									X
hnqw; iy...f	X	X	X					X									X

Key to Columns:

1	iry p't	2	h3ty-'
3	smr w'ty	4	sd3wty bity
5	hry-tp nzwt	6	Titles of king's son
7	imy-r hwt wrt 6	8	imy-r zš ' nzwt
9	imy-r k3t nbt (nt) nzwt	10	imy-r šnwty
11	imy-r prwy-hd	12	Titles with wd(t)-mdw
13	imy-r šm'w	14	wr 5 pr dhwtj
15	'3 dw3w	16	shd hm-ntr of a pyramid
17	imy-r niwt of a pyramid		

It may thus be concluded that the titularies of the memphite and provincial viziers who were approximately contemporary were not dissimilar. The non-memphite viziers, not surprisingly, show more involvement with provincial administration, while the supreme office of legal administration and labour organisation remained the preserve of the memphite incumbents.

D. The Career Structure of the Vizier

It will be evident from the preceding sections that there is no clear-cut common path taken by all officials who reached the vizierate. None of the biographies speak of this final stage of promotion. The nearest one may come is in the late Old Kingdom to Middle Kingdom 'Instruction of Kagemni', which only shows that the previous vizier was reappointed to his post by the new king.¹

1 Gardiner, JEA 32 (1946), pl. XIV (II, lines 7-9).

The pre-vizierial careers of the following non-royal holders of **t3yty z3b t3ty** can be documented as they were promoted after much of their tombs had been decorated: **sš3t-htp**; **hti** (labour organisation), **k3i** (136) (legal), **sšm-nfr** III (scribal), **r'-špss** (legal), **ptḥ-htp** II (legal with some provincial administrative titles) and **tp-m-'nh** (unclear, perhaps legal/scribal).¹ **sš3t-htp** belonged to the period when king's sons (real or otherwise) formed the upper levels of the administration. For the rest, there is a preponderance of officials with a basic legal or scribal background. However, chapters 3 and 4 have shown that there is insufficient evidence from the titularies of viziers for this certainly to be the case for most of the other holders of the title.

This does imply that the other viziers were appointed before the construction of their tombs, as if they in fact knew that they were to be promoted to the vizierate in due course, or else that the construction of a tomb was left until the owner felt he had reached his highest likely office. It is possible that a man may have been singled out as a future vizier earlier in his career and generally would have received this promotion by the normal (at present unknown) age when an individual constructed his tomb. Doubtless several of these picked individuals died before taking up their promotions; **hnmw**; **hnmw-nti** (111) of the reign of Pepy II may have been one such official (page 208).² Following the death of such an official it may have been sometimes necessary to promote a man who would not otherwise have reached the rank of vizier. In the case of **k3i** (136) such an unexpected promotion may explain the prominence he gave to his old honorific title **hry-tp nzw** in his vizierial titulary.

The career of a vizier may be seen more clearly in the fourth and early fifth dynasties. Most of the holders in this period were true king's sons, and it is very likely that promotion to high offices and ultimately the vizierate was made on a basis of seniority, providing the individual was still in favour. There is no

- 1 Doubtless other men were similarly promoted but it is not so immediately obvious. **'nh-m-'-hr**; **zzi** is one such possibility, as his vizierial titulary seems only to be found in the innermost part of his tomb, while the outer parts show him as **imy-r ḥwt wrt**, a title not found with viziers. Detailed examination of the layout of further tombs will doubtless establish similar examples.
- 2 Further evidence to support this contention may be derived from

one of his titles,  , perhaps **t3ty sktt**. The

appearance of the word **t3ty** suggests some connection with the vizierate; Jéquier has suggested that this title represented a senior administrative position (*ASAE* 35 (1935), 146). **sktt** could derive from a number of words: if one were to relate it to the verb **ski** (*Wb* IV, 311-2), 'go down', one could see in it a term for a subordinate vizier so as to differentiate between him and the full vizier, **t3yty z3b t3ty**.

evidence for or against kings having held the vizierate in the Old Kingdom before their accession to the throne. At least four of the sons of Khufu buried in the principal mastabas of the Eastern Cemetery at Giza reached this office (**k3i-w'b** (140), **h'f-minw** (103), Name Lost (170), and **h'f-hwfw** (104)). Similarly, the elder sons of Khafre would seem to have been those buried in the quarry east of his pyramid, many of whom reached the vizierate (**ny-k3w-r'** (78), **nb-m-3ht** (81) and **iwn-minw** (7) for example). As far as is known, **hw-n-r'**, the eldest son of Menkaure,¹ did not reach this office; from about this time onwards, non-royal individuals attained the vizierate, although granted the title of king's son. This can only have been due to the special favour that they enjoyed, and they were consequently allowed to build large tombs at Giza.

Thus can be seen the beginning of the promotion of private individuals to the highest office by virtue of their favour with the king as opposed to simple family choice. Also possible for the succeeding periods (where there are no family ties between the viziers and the king) is promotion through excellence. Although stereotyped, this (and performing one's tasks satisfactorily) is a virtue much emphasised in the Old Kingdom biographies especially where it relates to the king.² It is perhaps then very likely that a mixture of administrative efficiency and royal favour combined to elevate a man to the vizierate; in an autocratic society such as ancient Egypt, no king would surely ever promote a man to the vizierate if he were not already a favoured individual.

The number of important administrative titles actually held by a vizier may similarly be related - the more trusted an official, the more offices he held. It is possible that to some extent offices would continue to be held from the pre-vizierial career, but the material is insufficiently clear for the truth of this proposition to be established.

The Organisation and Functions of the Vizierate

A. The number of contemporary Viziers

By far the greatest problem with the office of **t3yty z3b t3ty** is the degree to which its holders were contemporary. This may be divided into two particular issues, the existence of a vizier in the provinces, and the number of contemporary viziers in the capital.

1. The Provincial Viziers

The viziers buried in the provinces probably date from the later fifth dynasty until after the end of the Old Kingdom. Their order by date is only tentative (table 31), and it is by no means certain

1 Tomb, PM 32, 293-4.

2 For example: **r'-wr** (Urk. I, 232.12), **nbbw** (90) (Urk. I, 220.12), and **ppy-nht** (Urk. I, 134.12).

that they followed in an unbroken sequence, with just the place of burial varying. The two most dubious dates are those of the second **hrwy** at Akhmim and **iww** at Abydos, as so little information is available about them. They are so placed because the ensuing order provide a reasonably consistent sequence of locations of places of burial: Akhmim, Edfu, Abydos, Meir, Koptos and Deir el Gebrawi (after the end of the Old Kingdom).

That these men existed alongside a memphite vizier is likely, firstly because of the improbability of the senior administrator's office being well away from the capital; secondly, the depiction of the vizier **idi** known from Abydos is found in the same room as that of the presumed memphite holder of the office, **ihy-hnt** (16), in the pyramid temple of Pepy II.¹ That these two men represented the administration of Upper and Lower Egypt respectively has been suggested by Kees,² but denied by Helck. The latter's reluctance to admit of more than one vizier with administrative power leads him to postulate the existence of 'titular viziers', that is, men bearing the title **t3yty z3b t3ty** with honorific function only, and no association with the practising holder of the title.³

Such a view seems a very desperate attempt to explain away an embarrassingly large number of viziers. It is clearly impossible to tell whether such a division of the title **t3yty z3b t3ty** would have created problems for the ancient Egyptians, but those that it places before the modern reader are best illustrated in Helck's own words:

Auch hier is "Vezir" also nicht die Bezeichnung eines Inhabers eines bestimmten Amtes, sondern bezeichnet den Träger einer bestimmten Befehlsgewalt, auch ohne Verbindung mit dem Amt eines Vezirs.⁴

It is perfectly comprehensible for an ancient functional title to have lost its original significance and become an honorific or ritual title (as is the case with **hrp 'h** and **hry-wdb m hwt 'nh** for example), but I cannot bring myself to believe that a title could have both functional and honorific meaning simultaneously.

No evidence exists in writing for a 'Southern' and 'Northern' vizier, although the Old Kingdom is notoriously imprecise in the qualifications of very important titles. A division of the office into two parts would surely be the first step towards the better-attested divisions of that office in the Middle and New Kingdoms.⁵ Kanawati has proposed the existence of a division along geographical lines from the later fifth dynasty to the end of the Old Kingdom.⁶

1 Jéquier, *Pepi II II*, pl. 48, 57.

2 *Vezirat*, 39 ff.

3 *Beamtentitel*, 116-7, 136 ff.

4 *op. cit.*, 116.

5 For a survey of the evidence for this, *id.*, *Verwaltung*, 19-28.

6 *Governmental Reforms*, in particular pp. 15, 23-4, 30-3, 62-4, 75-7, 89-90, 96, 112-3.

Chapter 8 - The Viziers

2. The Number of contemporary Memphite Viziers

Table 32

Distribution of Old Kingdom Viziers by date

Period (Years)	1	2	3
Fourth - early fifth dynasty (115)	16	0	7
Sahure - early Djedkare (45?)	9	0	5
Djedkare - end fifth dynasty (51)	12	2	4
Teti - early Pepy I (35?)	7	1?	5
Mid Pepy I - early Pepy II (55)	9	2	6
Mid Pepy II - end Old Kingdom (90?)	13	6	7
Immediately post Old Kingdom	1	2	0

All period lengths are approximate

Key to Columns:

- 1 Number of memphite viziers.
- 2 Number of provincial viziers.
- 3 Average length of tenure by memphite viziers, based on consecutive holding of the office.

This problem is far more difficult to resolve. Table 32 sets out the distribution of viziers by date over the Old Kingdom. This is based on the sequence of viziers given in table 28, which is only very approximate, and for many of the viziers at the extremes of the periods in table 32 the assignation to a particular period is almost arbitrary; for example, hnmw-nti (113) is placed in the reign of Teti but could equally be at the end of the reign of Wenis, while the reverse is true for pth-htp II (50). The averages based on consecutive tenure are not high at all periods; the average length of an Egyptian official's career is not known, but one would not expect the vizier to be the youngest of officials, even though the nature of his previous career is uncertain. Possibilities that would lengthen the average tenure of this office are short overlaps between viziers, or a practice of appointing contemporary viziers.

It is very difficult to find evidence to substantiate either of these proposals, especially since the chronology of viziers is far too fluid for any such overlaps to be immediately apparent. Regarding the first suggestion, it would seem reasonable that the incumbent vizier would perhaps take alongside him at some date in his office the future holder of the office to prepare for a smooth transfer of power at the end of the former's career.

It is possible that at some points such a practice developed into the existence of two full contemporary viziers. Helck has advocated this from the reign of Djedkare onwards, but with the second man holding the office of t3yty z3b t3ty in a purely honorific capacity. This has been rejected above. More recently,

Kanawati has advanced the theory that, beginning in the reign of Djedkare, there were two viziers serving simultaneously in the capital.¹ This reduces the number of successive viziers in this reign, and avoids the problems of having viziers of different types. As Kanawati points out, the two officials would have had different functions, and it is very likely that this may have been on a geographical basis, which explanation has also been advanced for the multiplicity of non-viziers holding titles such as **imy-r k3t nbt (nt) nzwt** at this time. This situation probably still applied in the reign of Wenis, although exact details are not clear because of possible incompleteness in the material.² As the exact datings are still not sure, it is preferred not to place these officials into specific pairs.

The appearance of this probable duality in the vizierate coincides to some extent with the changes noted in the previous chapters. At some point in the later fifth dynasty the number of non-vizierial holders of the other major offices was reduced, resulting in no further non-vizierial **imy-r zš 'nzwt** and only a few overseers of works, the two granaries and treasuries. The number of holders of **imy-r hwt wrt** does not seem to have changed, only the status of its holders. It is suggested that an increase in the number of contemporary viziers resulted in a decrease in the number or complete disappearance of non-vizierial holders of these other titles. In the case of **imy-r zš 'nzwt**, the likelihood of there being two contemporary viziers holding the same office obviated the need for a non-vizier with the same title.

The remaining non-viziers at this time with important offices may have to some extent filled the gaps in the titularies of the viziers: for example, in the reign of Wenis the overseers of works **'nh-izzi** (26) and **hzi** (98) may explain the low number of viziers with this title. As **hzi** was also overseer of the two granaries and two treasuries, his functions may have completed further gaps.

The reign of Teti provides more substance for these theories concerning the vizierate. Kanawati believes the duality continued,³ and if one fills the gaps in the titulary of **'nh-m-'hr** (30) on the grounds of the damage to his tomb, then all the viziers of the reign held the same high offices. One also notes from this (admittedly short) reign a lack of non-viziers with high administrative offices; only attested with any certainty are **ny-k3w-izzi** (76) and **s3bw; ibbi** (116), both overseers of works. This reign seems to have witnessed the transfer of most power to the vizier; that there were two contemporary holders of this office is possible, and one has then to regard the very similar titularies as an expression of the particular favour and trust placed by Teti in a small group of men. Two of the high titles of **mrrw-k3i** (68), **imy-r**

1 **op. cit.**, 15.

2 For example, the vizierial titulary of **pth-htp II** (50) is incomplete, and no holder of **imy-r hwt wrt 6** is yet known, with the exception of **hnmw-nti** (113) who could also belong to the next reign.

3 **op. cit.**, 24-7.

šnwty and **imy-r prwy-ḥd**, appear only on the temenos wall of his tomb.¹ This suggests that he may have acquired these titles later in his vizierate, after the rest of his tomb had been decorated, as if to replace another holder who had recently died. This person could have been **k3i-gmni** (151) or **nfr-sšm-r'** (88), and suggests a duality or at least overlapping of the office at that time.

The viziers of the period from the reign of Pepy I to the early part of that of Pepy II must be discussed as a group, since, with a few exceptions, it is not possible to place them in a particular sequence. Kanawati again argues for a duality of viziers in this period.² The first viziers of Pepy I were probably **hnty-k3i** (109) and **mḥw** (69). Their titularies are not totally alike (**mḥw** was **imy-r ḥwt wrt 6** and **imy-r šm'w** while **hnty-k3i** was overseer of works), which is different from the situation in the reign of Teti. If they were contemporary, they could have divided the functions, **mḥw** being concerned with legal administration and **hnty-k3i** with labour organisation, and both with the control of finance. In this period there is a wide variety of combinations of high titles held by viziers, which could imply, if there were two contemporary holders of this office, that only between them may they have encompassed all the necessary functions. This period sees the first appearance of a number of viziers holding no other high titles - **tp-m-'nh** (155), **tnti** (158) and **zzi** (114). The functions of these viziers may have been something apart from the high administration, and they must have worked alongside another holder of the office with more administrative titles. **r'-wr** (93) is effectively between these two types of official, since he bore only the title of overseer of Upper Egypt, held otherwise only by **mrri** (67).

The same period may also complement the viziers with several non-viziers. **'nh-mry-r'** (32) and **nḥbw** (90) were overseers of works, **išfi** (19) and perhaps **k3i-ḥr-ptḥ** (150) were **imy-r šnwty**, and **išfi**, **ny-s'nh-3ḥt** (73), **ptḥ-špss** (53) and **mrri** (66) were all **imy-r prwy-ḥd**. Clearly at this time the high offices were held by a greater number of individuals than in the reign of Teti.³

The biography of **wni** provides a small piece of more direct evidence for the duality of the vizierate at that time. In his mention of the proceedings against the unnamed queen of Pepy II he says: **n wnt t3yty z3b t3ty nb sr nb im**, 'there being no vizier nor official there'.⁴ As Kees has suggested, there would be no need

1 Duell, *Mereruka* II, pl. 218A.

2 *op. cit.*, 34-5, 54.

3 This suggests that Kanawati has perhaps overstated the case for Pepy I placing his trust in a few high officials (*op. cit.*, 28-30). Such a view does not really accord with the somewhat haphazard locations of the burials of these men, and the actual increase in the number of high officials known. **wni** was clearly a favoured official, but it is not to say that this was any more so than in earlier times, but rather that such an account has only survived from this particular period.

4 *Urk.* I, 100.15.

for the first *nb* if there was only one vizier anyway.¹ Apart from the possibility that this may be too literal an interpretation, it could perhaps also refer to a provincial vizier.

In addition to the Upper Egyptian vizier *idi* and the Memphite vizier *ihy-hnt* (16) in the pyramid temple of Pepy II (above page 322), there is also the vizier *hnw* (108) shown in the original decoration. It is possible that he may have been contemporary with *ihy-hnt* (16) thus showing the existence of two simultaneous memphite viziers in the second quarter of the reign of Pepy II.² Nothing further is known about the titularies of these two memphite officials. Apart from them there are five further viziers known from South Saqqara for this reign: *mry-r'-i3m* (61), *šn'y* (133), *h'-b3w-hnmw* (102), *ny-hb-sd-nfr-k3-r'* (72) and *tti* (156). Additionally there was *k3i-htp* (149), *impy* (62) and *s3bw-ptb* (117), whose tombs were constructed elsewhere, as well as the less well-dated officials *nb-k3w-hr*; *idw* (82) and *wr-k3w-b3*; *ikw* (40). Numerically there is no reason to suppose that the probable duality of the earlier period was not continued. From the standpoint of the titularies there is a distinct lack of instances of the high administrative titles. Overseers of works became very infrequent, and only *h'-b3w-hnmw* and *tti* held anything like a wide-ranging set of titles. The period immediately following the decoration of the pyramid temple (about the second third of the reign) is especially poor in viziers with these high titles. Non-vizierial officials may have supplied the functions of *imy-r šnwty* and *imy-r prwy-hd* (*hnmw-htp* (112) and *d3-mrw* (163), and *mn-'nh-ppy* (56), *šdy-ptb* (134) and *izi* (18) at the end of the period), while other holders of these titles, especially *imy-r šnwty*, are found in the provinces, both with viziers and non-viziers. The office of *imy-r šm'w* still appears occasionally with these memphite viziers (*šn'y* and *h'-b3w-hnmw*). One wonders whether this reduction might in many ways be related to the large-scale developments in provincial administration taking place in and after the reign of Merenre, in that the latter reduced the burden on the memphite officials.

In very broad terms, the reign of Pepy II and its immediate aftermath is very similar to the preceding period: many viziers are encountered, not all with high administrative titles, and they are complemented by several non-viziers. This spread of titles suggests that power was divided principally between two viziers, who together held most of this set of important administrative titles.³

The conclusion from the above survey of the period from the reign of Djedkare to the end of the Old Kingdom suggests that the vizierate in the memphite region was generally held by two men simultaneously. It is very likely that one would have been senior

1 *Provinzialverwaltung* II, 596 n. 1.

2 cf. Kanawati, *Governmental Reforms*, 78-9.

3 This again disagrees with the viewpoint of Kanawati, that the vizierate returned to the hands of one man in the second half of the reign of Pepy II (*op. cit.*, 98-9). His conclusions may be partly based on his overlooking the titles *imy-r k3t nbt* (*nt nzw't*) and *imy-r šm'w* in the titulary of *h'-b3w-hnmw*.

to the other, and in fact the dividing line between there being two full viziers and one vizier accompanied by a junior one preparing to succeed him is very fine indeed.

Is there any evidence that such a situation may have prevailed in the period preceding the reign of Djedkare? For the first period in table 32 the lack of a wide range of high administrative titles makes assessment of the situation as carried out in the previous pages difficult. It has been noted that among the viziers at the end of this period there were three who were not true king's sons, indicating the beginning of the move towards the exclusion of the royal family from such offices. It is perhaps possible that after this decision had been made, **dw3-n-r'** (161), **sš3t-ḥtp** (126) and **b3-b3f** (42) were appointed to work alongside the remaining true king's sons; two of them were overseers of works (and it is very possible that this title has been destroyed in the tomb of **dw3-n-r'**), which is not the case for any of the other viziers of the same time.

The likely true royal viziers contemporary with these men are not certain, but must have included **šhm-k3-r'** (125) who presumably died in the reign of Sahure. The difference between the titulary of this man and those of **dw3-n-r'** and the others is very marked. That of **šhm-k3-r'** is composed principally of the well-known honorific titles, and one or two less common religious ones, whereas the others consist of a wide range of honorific and religious titles as well as administrative ones. Several titles are found that previously occurred only at the beginning of the fourth dynasty, such as **ḥrp mrt t3-mḥw šm'w** and **ḥm-ntr wnw-r ḥnty minw**.¹ Also many new titles appear, particularly in the titulary of **dw3-n-r'**, the earliest of the three: for example, **ḥm-ntr ḥr inpw ḥnty pr smswt**, **ḥrp i3ts km**, **ḥry-tp nzwt m prwy**, **ḥw-** and **sd̄t nzwt** (the latter with **b3-b3f**). The first and last members of this group of titles, and also the much rarer **ḥm i3qs** (**b3-b3f**),² appear again in the reign of Neferirkare in the titulary of **w3š-pth** (37), the first vizier known not to hold the title of king's son. This implies some degree of similarity in titulary and perhaps functions between **w3š-pth** and his predecessors. Clearly, **dw3-n-r'** and the others were different from their royal counterparts and illustrate the direction in which the new non-royal bureaucracy was developing. In view of this, the existence of a royal and non-royal vizier side by side from the later part of the fourth dynasty to the reign of Sahure is probable.

The remaining period, from the end of the reign of Sahure to the beginning of that of Djedkare, is perhaps the most problematical, not least because its length is uncertain. This is the period where the vizier's highest rank is **ḥ3ty-**, **iry p't** being regained

1 These are otherwise found in the titularies of **'nh-ḥ3f** (34), **ḥm-iwnw** (96) and Name Lost (170), all of the reign of Khufu. Note that the latter of these titles can also be read **ḥm-ntr wnw-r ḥnty-ḥm**.

2 For the significance of this title, see Kees, ZAS 77 (1941), 24-6; Helck, *Beamtentitel*, 42.

only in the time of Djedkare. It is also important for seeing the introduction of the remaining high offices, and consequently there are not many of these that can be juxtaposed to discern whether there was more than one contemporary vizier. The first three viziers of this period in table 28 are well-dated: **wr-b3w-b3** (39) in the reign of Sahure, **w3š-ptḥ** (37) in that of Neferirkare and **minw-nfr** (55) in that of Neweserre. The others are less surely dated, but fit into the remainder of the period. **pth-špss** is the only one among them not to bear **hry-tp nzwṯ** and **imy-r zš ' nzwṯ**, although he may be a special case because of his relationship to Neweserre. Non-viziers holding **imy-r zš ' nzwṯ** and/or **imy-r k3t nbt (nt) nzwṯ** are very common, but only **df3wi** (167) and **k3i** (137) held **imy-r prwy-ḥd** and **sšmw** (127), **ny-k3-r'** (80) and **r'-špss** (95) (before vizierate) **imy-r šnwty**. It is evident that the policy at this time was for both viziers and non-viziers to hold similar major administrative titles with the exception of **imy-r ḥwt wrt 6**. We have to conclude from this that a duality in the vizierate is possible in view of the shortness of the period, but that it cannot be certain because of the range of contemporary officials holding the same title.

In conclusion, a duality in the vizierate is possible for much of the Old Kingdom, perhaps often in its weaker form of one vizier functioning for a time with his appointed successor. A duality in the memphite vizierate appears briefly at the end of the fourth dynasty, and is quite likely for much of the Old Kingdom from the reign of Djedkare onwards. This feature seems to have been instituted with particular purposes in mind: at the end of the fourth dynasty it was to ease the gradual removal of the royal family from state offices, while at the end of the fifth it was part of a development that concentrated more power on fewer officials, most of it falling on the vizier who had thus to have an equal, or at least a subordinate, to share the burden. This burden, exemplified in the number of high administrative titles held by the viziers, seems to have been reduced as provincial administration was set up on a more local level. The frequency of viziers does not however seem to experience a corresponding drop, and it is likely that the earlier practice of a dual vizierate continued.

B. The Functions of the Vizier

The preceding section and the earlier chapters have made references to the function of the vizier. It is quite clear that when two viziers existed simultaneously in Memphis, some of the duties were shared between them, and some suggestions have been made above. Firstly, when there were other subordinate holders of one of these titles, it is probable that the non-viziers carried out the bulk of the work, with the vizier acting as overall head of that administrative area. One may imagine that he would pass on the royal commands and only in special cases actually be involved in the work itself, perhaps on particular tasks important to the king. Secondly, when no such subordinates existed, he may have had to carry a greater volume of the work. However, given the limits to the capa-

city of one official, it is perhaps likely that the changes noted, whereby these high titles were gradually transferred to the vizier, in fact only referred to the status of the title itself, and that the daily work was still carried out by lesser officials. This change can then be viewed as the transfer of more titles away from men not of the vizier's rank, thus raising the status of **t3yty z3b t3ty** against that of the non-viziers. This may be the result of a desire on the part of the king to concentrate official responsibility on fewer persons, suggesting that the proliferation of offices in the preceding period had gone a little too far. Thus it is likely that for much of the time the vizier bore his high titles as a mark of his importance and a reflection of final responsibility in matters. This view probably holds true for most important offices he held.

The only title carrying a specific role that was confined to the vizier is **imy-r hwt wrt 6**. It is still thought to represent the overall legal authority of the holder of that office, but it would also appear from later evidence that the vizier acted as a court of appeal, and also that there were certain matters with which only he could deal (above page 194).

The following are the principal sources of information as to the responsibilities of the vizier in the Old Kingdom:

- 1 The names of two viziers appear in the Abusir Papyri. One, whose name begins with **p** (see above page 300), is found in a list of officials, the nature of whose relations with the temples of Neferirkare is unclear. It does show however that viziers were sometimes in contact with such institutions. There also appears a body of priests named after **minw-nfr** (55), vizier of Neweserre.¹ This is however probably to be viewed more as part of the relationship between the royal cult and those of private individuals than as any particular concern of the vizier with the temple.
- 2 The decree of Pepy I for the two pyramids of Sneferu at Dahshur,² and that of Pepy II for the temple of Min at Koptos,³ have the common purpose of exempting the employees and tenants of the two institutions from specific types of service, notably that on behalf of the state. The vizier is mentioned among the addressees of these decrees, and is clearly the senior official to be charged with the duty of ensuring that these exemptions were enforced, or indeed was the senior official who might attempt to conflict with the purpose of the decree.
- 3 In the decree of Neferkauhor to officials of Upper Egyptian nomes five to nine inclusive is found the following text:

- 1 Posener-Krieger, **ArchAb** II, 568-70.
- 2 Borchardt, **ZAS** 42 (1905), 1-11, pl. I; **Urk.** I, 209-13; Goedicke, **Königl. Dokumente**, Abb. 5.
- 3 Koptos B: **Urk.** I, 280-3; Goedicke, **op. cit.**, Abb. 8.

h3 rk r sht hn' (titulary) t3yty z3b t3ty šm3i ir nk (for rk ?) wpt-' n minw-gbtyw-s'nh-nfr-k3w-hr m b3wy smnh wpt tn m zš sip.k n (titulary) t3yty z3b t3ty šm3i swt m3' r hry htm md3t r iti r ht

Go down to the fields with the vizier šm3i and make an inventory (?) for the estate "Min of Koptos causes Neferkauhor to live" in the Koptite Nome record it carefully in writing and hand it over to the vizier šm3i who shall take it to the department of sealing documents and to the land-registry.¹

- 4 A letter, probably of the later sixth dynasty, contains a complaint to the vizier about commands he had sent concerning the supply of clothing to the workmen at Tura.² The precise details of the text are not important here; what matters is that the vizier is shown concerned with the administration of labour-organisation.
- 5 The biography of k3i-m-tnnt (146) provides further evidence for the involvement of the vizier in labour-organisation. The vizier r'-špss (95) is twice mentioned in damaged portions of this text, which are conjecturally restored to show this man being summoned to the palace and sent to Tura to obtain a false door for the tomb of k3i-m-tnnt (146).³
- 6 The biography of wni illustrates the legal functions of the vizier. He, as z3b iry nhn, heard cases along with the vizier,⁴ and heard the case against the queen of Pepy I alone, without the presence of the vizier.⁵ The implication of the second example is that the vizier would have heard the case but was prevented from so doing (perhaps by disgrace - see in the Prosopography under r'-wr (93)). wni thus acted in the manner of the vizier, assisted by a z3b iry nhn (cf. page 189).
- 7 That the vizier visited the various provinces, inspecting, giving judgement and enforcing royal commands, is suggested by a passage from the decree of king Horus dmd-ib-t3wy for the estates and monuments of the Upper Egyptian vizier idi:

ir gr hry-tp sr nb nfr.n hsf.f ht m sp3t.f n rmt nb irt.ty.sn šsrw pn r pñ nzw t3yty z3b t3ty srw

1 Koptos L: Urk. I, 296.1-16; Goedicke, *op. cit.*, Abb. 17.
 2 Now Cairo JE 49623: Gunn, *ASAE* 25 (1925), 242-55, pl. I a, b; further comments, Gardiner, *JEA* 13 (1927), 75-8, Grdseloff, *ASAE* 48 (1948), 505-12.
 3 Urk. I, 183.12, 17; restorations, Schott, *Fs Otto*, 450.
 4 Urk. I, 99.5.
 5 Urk. I, 100.15-6.

As for any local notable or official who does not punish anyone in his nome who does damage to these things until the king, vizier or officials come round¹

- 8 The arrival of a command sent by the vizier is mentioned in the biography of **s3bni** of Aswan: **iy.n wd n t3yty z3b t3ty...**, 'the command of the vizier arrived...'²

Other letters, decrees and the like to viziers from the king are usually concerned with praising the individual, as opposed to giving us some ideas of his functions, with the exception of those of Djedkare to **sndm-ib; inti** (120) relevant to labour organisation (see above page 240-1).

The associations shown of the Old Kingdom viziers with temples seem to have been very much on a secular level; where this can be distinguished, it would seem that it was his job as senior administrative official to ensure that these requirements of the king were carried out. Other texts show the vizier performing activities which were perhaps done in his function of **imy-r k3t nbt (nt) nzwt** and **imy-r zš 'nzwt**.

One feature common to all the above pieces of evidence is that they could all be regarded as special responsibilities of the vizier. The royal decrees all refer to institutions of importance (cult temples and pyramids) and the letter of Djedkare to **sndm-ib; inti** refers to the king's **mrt** temple, while the Tura quarry must have been especially important to the king as it was the major source of high-quality building stone for the memphite region. The particular lawsuit referred to by **wni** was against no ordinary individual but a queen. This would support the suggestion that the bulk of the work associated with the titles held by the vizier would be performed by lesser officials; one of the clear roles of the vizier would be to take charge of particular sub-sections of the responsibilities of these titles, mainly those which were the most important to the king and the state. This latter conclusion fits best the available evidence, even though this must be biased by the non-survival of documents of a more everyday nature. It is also clear from this material that it was one of the vizier's tasks to visit the provinces to ensure that royal commands were being enforced.

This evidence applies to viziers of the fifth and sixth dynasties, and none is forthcoming from the preceding period. The range of high titles evident in the fourth dynasty was just **t3yty z3b t3ty, imy-r pr-hd** and **imy-r k3t nbt (nt) nzwt**. The latter title has been suggested above as possibly covering a greater range than in the fifth dynasty (page 250), and the same could be true of the vizierate and **imy-r pr-hd**. The vizier is likely, on evidence from the rest of the Old Kingdom, to have controlled the royal documents and the legal system. It is evident that the creation of a sep-

1 Urk. I, 306.2-8; Goedicke, *op. cit.*, 215.

2 Urk. I, 140.4.

arate overseer of the treasury was found to be necessary, probably because of the workload. The question of revenues would thus have been dealt with by both the *imy-r pr-hd* and the vizier, and the same pair may have also been in charge of the administration of the granaries. Presumably the creation of new titles in the fifth dynasty represented an acknowledgement of the wide and diverse responsibilities previously held by the vizier and holders of these other offices. The function of the vizier in the Middle and New Kingdoms is somewhat clearer than in the Old. Helck gives examples of holders of this office in charge of, for example, building works, expeditions, the necropolis, military matters and the installation of priests.¹ To this we can add the administration of royal dockyards,² prisons,³ as well as the more obvious legal system and revenues (about which more below). The most convenient ancient Egyptian source to consult for this subject is the group of texts known as the 'Duties of the Vizier'.⁴ In this text, the vizier is shown to be responsible for the following: fortresses, storehouses, the activities of the royal palace, daily reporting to the king, judgement (especially of disputes over the ownership of land, and other localised affairs),⁵ the sending and receiving of documents concerned with judgement and also of royal commands, the sealing of wills, appointment of local officials, the assembly of the army when required, the organisation of work on the land and finally the assessment of taxes.

Some degree of parallel may be found between this later evidence and that from the Old Kingdom. Expeditions and military matters do not seem to have been part of the vizier's responsibilities, except perhaps if he was an overseer of works. Matters relating to domestic labour-organisation seem to have come under the vizier to some extent, as did the legal system. Nothing is known about the appointment of priests in the Old Kingdom as far as the vizier was concerned; his connections with temples were mainly secular; about

-
- 1 **Verwaltung**, 44-50.
 - 2 Vizier *ini-itif iqr*, reign of Senwosret I, Simpson, **Papyrus Reisner II**, 20 (D), 22 (G) (text), 23 (comments).
 - 3 Thirteenth dynasty vizier *'nhw*, Hayes, **A Papyrus of the Late Middle Kingdom in the Brooklyn Museum**, 71, 72 (text), 82 and 85 (comments).
 - 4 Principally that in the tomb of *rh-mi-r*' at Thebes, **Urk. IV**, 1103-17, with additions from parallel texts. These are translated by Helck, *op. cit.*, 29-43 and Davies, **Rekh-mi-re' I**, 88-94. This has often been thought to be a composition originally of New Kingdom date, but it has recently been argued that it was produced in the early eighteenth dynasty, at a time when the country was looking towards the achievements of earlier times (van den Boorn, **Or** 51 (1982), 369-81; this also contains further references to other aspects of the text).
 - 5 A Middle Kingdom or Second Intermediate Period vizier is shown acting in judgement regarding the possession of a slave-girl, and enforcing his judgement when it was queried (Smither, **JEA** 34 (1948), 31-4).

the necropolises and revenues little is known, but the presence of the titles *imy-r w'btj*, *imy-r šnwty* and *imy-r prwy-ḥd* in vizierial titularies strongly suggest that these were also his responsibility in the Old Kingdom.

The following additional comments apply specifically to the extra responsibilities noted in the 'Duties of the Vizier' texts: the concern of the Old Kingdom holder of *t3yty z3b t3ty* with documents is embodied in the very frequent appearance of *imy-r zš 'nzwt* in his titulary, while the decree of Pepy II noted above illustrates the concern of the vizier with fields. In this case *šm3i* was responsible for sealing the deed when produced; however the sealing of wills in the New Kingdom text is not paralleled in the Old Kingdom where it seems to have been the responsibility of groups of witnesses.¹ The vizier of the Old Kingdom could have controlled the organisation of work on the land in his capacity as overseer of works.

Nothing is known about the other responsibilities, although there is no reason for doubting that they existed in some form in the Old Kingdom. One receives the impression that the New Kingdom texts describe an all-important role for the vizier which was also true for the Old Kingdom, making due allowance for intermediate administrative changes.

There is no apparent equivalent in the Old Kingdom to the Middle and New Kingdom *ḥ3 n t3ty*, 'the office of the vizier'. The Old Kingdom exhibits no title that is compounded with the expression *t3yty z3b t3ty*. Only twice do titles occur that may be related to the vizier. One is *t3ty sktt*, which has been explained above as possibly a term for an intended vizier (page 320 n.2); the other is



, *t3yty*, found alone on several monuments of *z_{tw}*.² This

title must be associated with the 'curtain' or 'door' element included in the term translated here as 'vizier'; it cannot be an abbreviation for *t3yty z3b t3ty* as the all-important *t3ty* element is missing, and in addition *z_{tw}*'s simple titulary (*rḥ nzwt*, *ḥry-sšt3*, *z3b imy-r zš*) is hardly in keeping with the forms outlined above. It could perhaps be a rare title denoting a position in the palace (?).

The equivalent of the *ḥ3 n t3ty* in the Old Kingdom was probably the conglomeration of important departments supervised by the vizier, the principal ones of which have been examined above. Two stand out as being his particular concern: the courts (*ḥwt wrt 6*) and the document offices (*iz n 'nzwt* and associated departments). Doubtless the vizier would have needed his own personal bureau-

1 cf. Goedicke, *Die privaten Rechtsinschriften aus dem Alten Reich*, 41, 195; the will (*imyt-pr*) of *ppi* (Urk. I, 35) was witnessed by a group of individuals, while the document concerning the sale of a house (Urk. I, 157-8) was sealed in the presence of the *d3d3t* of the pyramid of Khufu.

2 Offering stands Cairo, CG 1298 and 1301 and block Cairo, CG 1494.

cracy, as shown by the existence of the title *zš n t3ty* in the New Kingdom; it is inherently probable that the Old Kingdom lack of precision in the qualification of such titles prevents one from identifying those officials concerned particularly with the responsibilities of the vizier. The concern of the vizier identified above with scribal and legal matters places officials of both types in the forefront of those belonging to the Old Kingdom office of the vizier;¹ titles of these types form the largest sub-groups in the titulary of a vizier, although they are by no means found with every holder of that office.

The exact division of functions between the viziers in the capital and those in Upper Egypt is of course unknown. It is to be presumed that they exercised very similar functions for the two parts of the country. It is perhaps unlikely that two separate bureaucracies existed, but rather that the principal administrative centre of both viziers was in Memphis, with only a small bureaucracy in Upper Egypt, probably at the place of residence of the vizier. This is advanced because of the fact that this location changed during the sixth dynasty, and there is no evidence to suggest that the king who issued decrees like those discussed above resided anywhere else in the Old Kingdom but the memphite region where he was to be buried. It is thus probable that the provincial vizier was subordinate to the one in the capital, which latter would have been at the centre of matters. The memphite vizier bore the greater number of administrative titles; the provincial holder of that office seems to have functioned as the senior government representative in Upper Egypt, with duties not unlike those of the overseer of Upper Egypt.²

Conclusions

The vizier was clearly the senior administrative official in the Old Kingdom, with a very distinctive titulary, particularly as regards honorific and religious titles. It is likely that two memphite viziers existed simultaneously at several periods, particularly from the later fifth dynasty onwards, at which time they were complemented by a vizier with special responsibility for Upper Egypt. The duties of the vizier were very wide. He seems to have been particularly concerned with matters directly relevant to the king, but also to have acted as the final authority below the king. He was very closely associated with the administration of royal commands and documents as well as the legal system.

The origin of the title *t3yty z3b t3ty* is unknown. The officials discussed above cover the period from the beginning of the fourth dynasty onwards, although there is an isolated instance of

-
- 1 Such a collection of titles is given by Helck, *Beamtentitel*, 68-77.
 - 2 Martin-Pardey, *Provinzialverwaltung*, 158, although her concept of the provincial viziers is somewhat different from that advanced here.

this title from the end of the second or beginning of the third dynasty (**mn-k3**, above page 300).¹ Sethe and Gardiner² suggest that the term **t3yty z3b t3ty** be derived from the title  found on

the Narmer Palette, although Helck views this personage as a precursor of the later **sm** priest.³ There are other titles from the early period which may have represented the later office of vizier.⁴ The office of vizier or an equivalent may thus have existed in the Archaic Period, but a continuous line of holders is only clearly attested from the reign of Sneferu.

In conclusion, it may be seen why the title **t3yty z3b t3ty** was translated 'vizier' in the nineteenth century: allowing for the differences between the societies of the Ottoman Empire and ancient Egypt, the image of an individual responsible only to the king who had then to pass on his commands to officialdom is not very far removed from the picture built up here of the office of **t3yty z3b t3ty** in the Old Kingdom and later.

- 1 If the other sign in this inscription really is **hwt wrt** then we can have a clear connection of the vizier with legal matters going back well before such titles as **imy-r hwt wrt 6** were created.
- 2 Respectively, **Pyr. Ubers. I, 11 (137d); AEO I, 19 ***.
- 3 **Beamtentitel**, 16-7.
- 4 Kaplony, **Inschriften**, 488-9.

PART IV

Conclusion

Conclusion

The preceding analysis of titles shows that in the fourth dynasty there seem to have been two principal state offices, those of the vizier and overseer of works. Between them they probably controlled most areas of the administration, although the existence of some overseers of the treasuries indicates that responsibility for financial management may not have been solely their concern.

The end of the fourth dynasty and the beginning of the fifth saw an expansion in the number of offices. The functions of the overseer of works were clearly divided, some being exercised by the holders of **imy-r k3t nbt (nt) nzwt**, others by officials who were **imy-r k3t (nt) nzwt**. The offices of overseer of the king's document scribes, overseer of the great mansions, overseer of the six great mansions, overseer of the granary and overseer of the two granaries were created; in addition, those of overseer of the treasury and overseer of the two treasuries, the appearances of which had formerly been somewhat irregular, were organised in a more systematic manner.

Whether these changes took place simultaneously is not so immediately apparent. The earliest holders of **imy-r k3t (nt) nzwt** are recorded slightly before the reign of Neferirkare; the first holder of **imy-r zš ' nzwt** was a contemporary of Neferirkare; **imy-r hwt wrt** and **imy-r hwt wrt 6** appear early in the reign of Neweserre; titles relating to the offices of overseer of the granaries appear in the early fifth dynasty but the first recorded holder of **imy-r šnwty** was in the time of Neweserre. The same reign also saw the first fifth dynasty holder of **imy-r prwy-hd**, which had previously appeared twice only in the fourth dynasty.

The above summary points to the period of the reigns of Neferirkare to Neweserre as being that in which these offices were organised on a systematic basis. It is tempting to associate this change with others in the administration which were taking place at about the same time. In his study of the title sequences of the Old Kingdom, Baer has suggested that a relatively organised system of ranking titles was introduced in approximately the time of Neferirkare.¹ The number of different titles in use seems to have increased at about the same time; clearly, the introduction of these new administrative offices was part of a more general change. The purpose of this change may have been to place the administration of the country on a more organised basis: one result of the creation of new offices would be to reduce the scope of those which had existed in the previous period, making the duty of each more specific. As an example, the functions of the title **imy-r k3t nbt (nt) nzwt** may be noted: in the fourth dynasty it is likely that this position, together with that of the vizier, was concerned with most higher state administrative matters. With the creation of new offices, such as **imy-r zš ' nzwt** and **imy-r šnwty**, the responsibilities of the **imy-r k3t nbt (nt) nzwt** may have been reduced to matters concerned more specifically with the organisation of labour, not only in building projects, but also more generally, such as in agricultural work.

1 Rank and Title, 296, 299-300.

Conclusion

This increase in the number of offices was matched by a more or less equivalent increase in the number of officials, as judged from the number of tombs known from the early to middle fifth dynasty when compared with the fourth. It is to be presumed that this increase in the size of the bureaucracy was planned by the rulers of the day, probably as a result of an eventual failure of the system as it was before.

As is well-known, the prevailing system for the larger part of the fourth dynasty was for the prime offices of state to be held by members of the royal family; there is an unbroken line of viziers certainly related to the king from **nfr-m3't** (86) at the beginning of the dynasty until perhaps some time in the reign of Menkaure or so, when **dw3-n-r'** (161), in whom there is no certain evidence of royal blood, is found as vizier.¹ Most overseers of works in the fourth dynasty were also related directly to the ruling king; many additionally reached the vizierate. However, from the later part of that dynasty onwards, more high officials are found for whom, like **dw3-n-r'**, there is no evidence of any family connection with the king. A conscious decision had been made, which can only have originated with a king, to open the higher state offices to men without affiliation to the royal family. This is most clearly illustrated by the viziers **dw3-n-r'**, **s33t-htp; hti** (126) and **b3-b3f** (42): if this position was open to men of such origins, other high offices could similarly be exercised by men with no connection by blood to the royal family. The transition was probably carried out in the following manner. It seems that a number of members of the royal family had been nominated for, or perhaps promised, the vizierate. To fulfil this promise, they were in fact granted the office of vizier but no other important state offices; alongside them was appointed a sequence of men of non-royal birth who held the offices of **t3yty z3b t3ty** and overseer of works. Of the two viziers probably in office simultaneously, the non-royal individual was the more important in the actual running of the country, while the 'royal vizier' was perhaps concerned only with the ceremonial and courtly functions of the office. The same may be true for the mixture of true king's sons and non-royal individuals who held the office of overseer of works at the end of the fourth dynasty. This process of gradual removal of the true members of the royal family seems to have been complete by about the reign of Sahure, from which time onwards the above-noted expansion of the administration took place.

It thus appears that the removal of the royal family from the administration and the increase in the number of offices and their holders were a result of the same policy decision. It does appear that the second change probably came out of a need to reorganise

1 It seems that none of these men can be considered as the 'crown prince'; there is no evidence of the actual position held in the Old Kingdom by the designated successor to the ruler of the time. This may be contrasted with, for example, the evidence for the future Amenhotep II as crown prince in the eighteenth dynasty (Glanville, ZAS 66 (1931), 106).

Conclusion

the administration as a result of the first.

The reasons for this change must have political. It is possible that they may have been connected with the evident, but very shadowy, disputes in the royal family in the middle of the fourth dynasty. Although we know nothing about the order of precedence at that time, perhaps the fact that the high administrative officials were also potential successors to the throne had caused the strife suggested by the damage to the funerary monument of Djedefre and the short and very obscure reign between those of Khafre and Menkaure indicated in the Turin Canon. Menkaure, or whoever authorised this change, may have hoped that by removing the family ties between the throne and the administration, civil strife, or at least disputes concerning the succession (inevitable with polygamy) might be harder to organise.

In the period immediately following this change, there seems to have been a reduction in the status of the vizier - no holders of this office in the mid-fifth dynasty held the highest honorific title of **iry p't**, which instead seems to have been held by officials holding no civil administrative titles, some of whom were actually true king's sons.¹ This change may be explained as an attempt to preserve some distinction between royal and non-royal individuals, now that the former were not part of the administration.

The next apparent change in the organisation of the administration, as witnessed from the evidence of the titles studied here, took place in the later fifth dynasty, no earlier than the reign of Djedkare. This latter reign is known to have seen changes in a number of different areas: for example, sun temples were no longer built and the system of ranking titles was changed for the first time since its inception. Additionally, king's sons (although usually titular princes) were again permitted to hold administrative titles (such as **k3i-m-tnt** (146) and **'nh-izzi** (26)), and the rank of the vizier was raised to **iry p't**. With regard to the high administrative titles, the most important change was the reappearance of the practice, perhaps discontinued in the early fifth dynasty, of appointing more than one contemporary vizier. This now took the form of one 'Southern' or provincial holder and two men with the same title in the memphite region; from this time on it seems to have become a regular practice. Also in the later fifth dynasty occurred a change in the status of the less-elevated titles considered in this work. Those of overseer of the granary, overseer of the treasury and **imy-r k3t (nt) nzwt** began to disappear, a process complete with hardly any exceptions by the early part of the sixth dynasty. This left the titles of overseer of the two granaries, overseer of the two treasuries and **imy-r k3t nbt (nt) nzwt** in these three administrative areas, the occupants of which offices below the rank of vizier most frequently bore only the one high title, another difference from the preceding period. Changes,

1 Some examples may be found in Schmitz, **Königsson**, 28-30; another is the recently discovered **nsr-k3w-ḥr** (Verner, **ZAS** 107 (1980), 164-5).

Conclusion

this time concerned with the status of the office, also occurred in the two remaining administrative areas discussed in the previous pages, those of scribal and legal administration. **imy-r hwt wrt** was the lesser of the two titles at the head of the legal administration: from the later fifth dynasty onwards it was most often held by men of appreciably lower status than in the preceding period, when its holders often simultaneously held others from the group of offices presently being considered. The change in respect of **imy-r zš ' nzw**t was quite the reverse: from the later fifth dynasty onwards it became the preserve of the vizier (or intended vizier) alone.

As a result of these changes it seems that more power was placed in the hands of the vizier(s), and proportionally less in those of officials of lower rank, while the range of high administrative titles was reduced. This is suggestive of a reaction against the administrative expansion apparent in the early fifth dynasty. Baer has suggested that adjustments in the system of ranking titles in the reign of Djedkare were as a result of officialdom amassing more power than the king felt was desirable.¹ Such concern on the part of the king may also be reflected in these changes in the organisation of the highest administrative titles in the land. It is evident that the number of tombs known from the memphite region for all but the least significant classes of tomb-owning officials is almost certainly lower in the sixth than the fifth dynasty. It is debatable as to whether it was indeed a wise decision to concentrate power in such a manner, but it must have seemed perhaps the only logical alternative at that time.

However, the growth in provincial administration from the later fifth dynasty onwards cannot be ignored in the context of the present discussion. Such administration seems to have been consciously increased, again perhaps from the reign of Djedkare, and is best illustrated by the appearance of a 'Southern' or Upper Egyptian vizier for the first time. Only in the case of the legal administration does there not seem to be an example of a holder of the supreme office, whether it be **imy-r hwt wrt** or **imy-r hwt wrt 6**, buried in the provinces; a clear case may be made for nomarchs conducting, on a provincial level, tasks which may previously have been the preserve of a memphite overseer of works or overseer of the granaries. In addition, some further functions originally held by such officials may have been subsumed into the new office of overseer of Upper Egypt, even though holders of this title were not buried in the provinces until the reign of Merenre.

To what extent was the decrease in holders of high-ranking administrative titles in the memphite region balanced by an increase in the number of provincial officials performing similar tasks? This is perhaps the explanation for one further reduction in office holders not yet discussed. After the reign of Pepy I, there is a very marked drop in the number of officials (apart from viziers) holding all high titles apart from **imy-r hwt wrt**. The reign of Merenre is notable for its increase in the number of

1 *op. cit.*, 297, 300.

Conclusion

provincial administrators, from which time onwards are found most provincial overseers of the two granaries and overseers of the two treasuries. There is such a close correspondence between the drop in memphite and the increase in provincial officials at this time that there can be little doubt that the two were largely complementary. Whether this change came from a desire to improve provincial administration or to disperse a number of perhaps uncomfortably powerful officials throughout the country is impossible to say.

In the period before the reign of Merenre, the evidence is less clear-cut. The reductions in the memphite administration were hardly balanced by the appointment of a vizier in the provinces, and some memphite officials must still have been concerned with provincial administration, such as the overseers of Upper Egypt buried at Saqqara. On balance it is preferable to regard the changes in Memphis at the end of the fifth dynasty from a political rather than simply economic or administrative point of view. Having altered the composition of the upper levels of the administration in the early fifth dynasty so as to stabilise the situation with regard to the succession to the throne, the rulers of the later fifth dynasty found themselves with a bureaucracy holding more power than they considered desirable. It is nearly impossible to decide whether this power was economic or political. It was perhaps economic, with these officials controlling a not insubstantial part of the wealth of the country, not only through the functions of their offices and their ability to organise manpower but also by their holdings of land in the form of funerary and other estates. Political it may also have been, as the officials' power perhaps caused them to take advantage of royal authority in a way that they had not done before. Some of the 'charters of immunity' granted by rulers of the Old Kingdom to temples and similar institutions in the form of royal decrees may have been designed to prevent such happenings.¹ By the measures outlined above a large part of the power in the administration was placed on the shoulders of the vizier(s), who would no doubt have been very highly trusted men; the remainder was split in such a way as to prevent any one official amassing too much of it. The success of this measure may to some extent be judged from the fact that no further major changes in the higher levels of the administration seem to have occurred in the remainder of the Old Kingdom which need to be explained in the same manner - the alternative view, that it was a complete failure since the Old Kingdom eventually collapsed, is perhaps less likely.² As an instance of the effects of this change on the economic power wielded by these officials, we note that a smaller number of funerary estates is attested in the sixth as against the fifth dynasty.³

1 Particularly the Dahshur decree of Pepy I, which actually mentions holders of certain titles as being prevented from taking temple personnel away for their own purposes (Goedicke, *Königl. Dokumente*, 56 (VI)).

2 cf. Kanawati, *Governmental Reforms*, 131.

3 Compare the relative amounts of documentation for these periods

Conclusion

It is clear that, at many times in the Old Kingdom, an important administrative title could be held by more than one man simultaneously. In its most frequent form, we see a vizier and a non-vizier bearing the same title, or at least a variant of it. The reason for this advanced here is that it would have been impossible for the vizier to have had a detailed knowledge of the day-to-day activities of all departments in which he held titles. The extent to which the vizier (or any official for that matter) actively exercised the functions of all the titles given him on his monument is not at all certain, since the evidence can be contradictory. In the case of the vizier it is probable that very many of his titles were acquired on promotion to that office. Only one title, **imy-r hwt wrt 6**, appears as solely the preserve of the vizier from its inception to the end of the Old Kingdom, although **imy-r zš 'nzwt** acquired this position at the end of the fifth dynasty. It is clear that the principal function of the vizier was the administration of the bureaucracy and the legal system. The remaining high administrative titles were not quite so important to his position.

Different links are visible between the titles. Prior to the restriction of **imy-r zš 'nzwt** to the vizier only, this office and that of **imy-r k3t nbt (nt) nzwt** went closely together, perhaps as the holder of the latter title was responsible for organising the execution of tasks planned in the office of the former. The connection between **imy-r šnwty** and **imy-r prwy-hd** was due to their concern with items of revenue, and their pairing together, especially in the titularies of the viziers, is apparent from the later fifth dynasty onwards. The offices of **imy-r hwt wrt** and **imy-r hwt wrt 6** stood apart from the others (apart from some associations of the former with **imy-r zš 'nzwt** in the fifth dynasty only), but were doubtless linked to all of them in the course of disputes which arose in each department.

It is clear that the further up the promotional ladder an official advanced, the less evidence we find in his titulary for his holding other titles associated with the administrative departments of which he held the highest offices. The two obvious explanations for this are that proven administrative ability was of far more relevance than a detailed knowledge of the jobs to be done, and also that a favourable opinion on the part of the ruler of the land towards the particular individual and his loyalty to the crown counted for a great deal. It cannot be doubted that this personal aspect was by far the most important when it came to the selection of officials for the highest positions.

The degree to which royal favour extended in the promotion of some officials may be exemplified by the career of **ty** (157). To judge from the extremely elaborate nature of his tomb, he was a man who received an unusually high degree of favour from the king, whereby he gained the means to erect this monument. His position

in Jacquet-Gordon, *Les noms des domaines funéraires dans l'ancien empire égyptien*.

was basically that of *iri šn*, usually translated 'hairstylist'. Any individual carrying out such personal service for the king would have to be highly trusted; what is more, his proximity to the ruler must have given *ty* the opportunity to counsel him at times. Other individuals who carried out similar functions were also highly honoured, such as *ny-'nh-hnmw* and *hnmw-ḥtp*, who were manicurists. However, the magnificence of the tomb of *ty* surpasses that of all other men of similar standing, and, of particular relevance to the present discussion, he was the only man from this background to attain offices of the magnitude of *imy-r k3t nbt (nt) nzwt* and *imy-r zš 'nzwt*. His high standing with the king can be the only explanation for these promotions.

Examination of the vizierate gives us one of the most interesting illustrations of the Old Kingdom system of promotion and its relationship to the favour the individual enjoyed with the king. There can be no question that the individuals chosen for this position must have come from a very highly trusted group of officials, presumably the reason why this title was originally granted only to members of the royal family, a decision that in time seems to have given rise to unforeseen problems. The titularies of the viziers of the fourth dynasty show that all these men were not necessarily overseers of works, the other high office in existence at that time. This raises the intriguing matter of the extent to which the vizier actually held the other high titles listed along with *t3yty z3b t3ty*. We have seen that often the vizier was acting as the overall head of the department, with lesser men attending to detailed matters. It is also probable that viziers exercised the powers of these other titles to different extents in different reigns. That of Teti is a good example: it seems that all five or six memphite viziers who may be assigned to this period held approximately the same set of high administrative titles, with a corresponding reduction in the numbers of non-viziers holding the same offices.

Further study of the vizierate also provides some evidence regarding the timing and likelihood of an official's promotion to this supreme office. Several men, such as *k3i* (136) and *sšm-nfr III* (131), commenced the building of their tombs at a time when they were below the rank of vizier, but for the majority of officials there is no such evidence. It is possible that an official might know by a certain point in his career whether or not he was likely to be promoted to the vizierate, and that there existed a very select group of officials who were intended for this office. Such an idea is supported by the one occurrence of the title *t3ty sktt (hnmw; hnmw-nti* (111)), which perhaps indicated a vizier-designate who died before attaining the full office of *t3yty z3b t3ty*. The promotion of officials such as *k3i* and *sšm-nfr III* is perhaps to be explained by the unexpected death of such designated viziers. From the relatively rare biographies which give some idea of an official's promotions, one sometimes wonders whether certain individuals were elevated to very high office with few intermediate steps. This possibility aside, it is evident that an official would refrain from decorating his tomb until he felt he has attained his highest likely office, which cannot normally have been early in life.

Conclusion

Perhaps each official in the Old Kingdom fitted into a particular group, the potential for promotion from which would depend on his background, ability and, above all, standing with the ruler of the time. Thus there could have been one group whose careers could culminate in the vizierate, another whose members could reach the high echelons of the administration, and so on. One such group, barely noted in these pages as they held no high administrative offices, consisted of men whose titularies contained almost exclusively 'courtly' and high-ranking honorific titles. The principal concern of these men must have been with personal attendance on the king, almost certainly exercising what ritual significance remained in their titles; connections with the administration were almost non-existent.

No clear promotional path is discernible among the highest officials of the Egyptian administration of the Old Kingdom. Beyond a certain level on the promotional ladder, the principal feature common to the many officials who held the very highest positions in the land was a high standing in the sight of the ruler of the land at that time, and it is to be supposed that the fortunes of some, if not many, officials changed in the course of time, especially since the succession of a new king would probably introduce a new group of men to the administrative system of the day - this is stressed in the 'Instruction of Kagemni' by the requirement that the subject of the text be reappointed to the vizierate by the new king. The high officials buried around the pyramids of Wenis and Teti would seem to have risen to particular prominence with their king; others, such as **sn̄dm-ib; m̄ḥi** (121), seem to have remained in important positions for two reigns.

The remaining comments cover several smaller points which arise indirectly out of the discussions in this book.

Concerning the administration at the end of the Old Kingdom, several officials dated above to the reign of Pepy II must have served during the brief period of the seventh and eighth dynasties, and it seems very likely that the officials discussed above who were buried in the smaller tombs of the Teti Pyramid Cemetery at Saqqara date to that time and the First Intermediate Period. The high office found most frequently is that of overseer of the two granaries; there are at most one or two holders of the others. The only certain memphite vizier of First Intermediate Period date is **ttw** (160), who, unlike many of his predecessors, did not bear the title of **imy-r zš 'nzwt**, suggesting the beginning of a break with Old Kingdom tradition. The remaining viziers known from the end of the Old Kingdom and later were active in Upper Egypt, and not particularly numerous - **šm̄ḥi** and **idi** at Koptos and **ḥm-r'**; **izi** and **hn̄qw; iy...f** at Deir el Gebrawi. It would seem that there was at most one memphite and one provincial vizier, and several of the major administrative titles of the Old Kingdom disappeared until the beginning of the Middle Kingdom, when some semblance of the older order was restored.

The situation at the beginning of the Old Kingdom is far more obscure. Some of the titles discussed here appear without doubt in the reign of Sneferu. Titles related to the vizierate and the overseer of works seem to have existed before that time, the former

being the older, but the evidence for a continuous line of holders in the third dynasty is lacking. The advent of the reign of Sneferu clearly marks a new phase in the development of the Egyptian administration, as well as witnessing development in other areas, notably funerary architecture and practices.

An examination of the locations of the burials of the officials in the Prosopography shows, not surprisingly, no consistency within each title. However, more patterns emerge when looking at the group as a whole. The fourth dynasty officials were buried in well-defined areas at Giza; within these areas, parts were reserved for members of the royal family, such as the Eastern Cemetery and the Khafre Quarry Cemetery, with the Western Cemetery being the principal burial place of the highest non-royal individuals. The tombs of the fifth dynasty are different in that they do not cluster around the pyramids of the kings their owners served. This is often seen as evidence of the growing independence of private officials.¹ In view of the suggestions above concerning the reasons for the removal of the royal family from the administration at the end of the fourth dynasty, the separation of the royal pyramid and private tombs could be as a result of a deliberate attempt to emphasise the division between the king and his high officials. The fact that most officials from the early fifth dynasty until the reign of Djedkare were buried in the Northern Cemetery at Saqqara, not an undue distance from the royal pyramids at Abusir and even closer to that of Weserkaf, suggests the designation of that area as a cemetery for such officials. Certain very favoured individuals were permitted tombs actually at Abusir; indications from recent excavations suggest the possibility that it may have been the cemetery of the royal family, including those who were no longer part of the administration of the land but whose right to a distinguished burial-place had not changed.

During both the fifth and sixth dynasties only occasional burials of important men are found at Giza - the reasons for this must have been in connection with family ties, offices connected with the pyramids there, or special causes which are no longer apparent.

A change may be seen at the end of the sixth dynasty, when many of the officials whose rise to power was due to the favour of Wenis were buried around the pyramid of that king. This may have been as a result of changes in the administration at that time: to emphasise the greater trust bestowed on perhaps fewer high officials, they were permitted to be buried in close proximity to the tomb of their king. The same practice was followed in the reign of Teti, when almost all important men known from this (admittedly short) period seem to have been buried around the pyramid.

It is evident from the officials dated to the reign of Pepy I that, as far as the available material is concerned, the above practice was reversed. Perhaps the policy of burying the highest officials around the royal pyramid had some as yet unknown undesirable consequences (possibly this practice suggested an uncomfortably close contact with the king?), and the same class of men

1 For example by Baer, **Rank and Title**, 301.

Conclusion

were henceforth interred in no one consistent location. That the same is true for the reign of Merenre is surely because this was too short to allow any particular such policy to develop.

Pepy II returned to the previous practice, and the majority of memphite tombs of important officials of the period following the construction of his pyramid are to be found at South Saqqara, around his funerary complex. Some officials buried there must also have exercised their authority in later reigns; however, new officials building tombs after Pepy's death seem to have sited them in the Teti Pyramid Cemetery. It may be speculated that the importance of this area from this time onwards was due to the location of the administration of the necropolis in that part of Saqqara.

From the need to examine lesser officials who held titles associated in some way with the departments studied, an impression can be gained of their places of burial. Much depended on their status as to whether their tombs were at Saqqara or Giza. The majority seem to have been at the latter site, which was clearly the necropolis for less high-ranking and less favoured men. Although not of the rank of most high officials, some of them with more impressive titularies were buried at Saqqara. Thus, in general, the location of one's tomb also depended very much on one's status and degree of favour with the king: as one of the officials discussed in this work, burial at Saqqara was almost certain, but the lower one was, the more likely was a site at Giza.

Research for the present work suggests that the structure of the upper levels of the administrative system remained much the same throughout the Old Kingdom, although with several changes in the classes of personnel chosen to fill the high offices, and there is no real evidence for a decline in the effectiveness of that system. The six offices studied seem to have controlled most secular activity in the land. Royal intervention is apparent in the form of periodic changes in this system, and there is no real basis for believing that the officials who ran the administration ever found themselves in a position where their power remotely rivalled that of the king. Many reasons have been advanced for the collapse of the Old Kingdom, but the balance of power within the upper reaches of the administration should not be regarded as one of them.

Bibliography

- ABU-GHAZI, Dia', **Catalogue général des Antiquités Egyptiennes du Musée du Caire: Denkmäler des Alten Reiches III**, fasc. 2: Alters and Offering Tables, Le Caire 1980.
- ALLIOT, M., **Rapport sur les fouilles de Tell Edfou (1933)**, FIFAO 10, Le Caire 1935.
- ALTENMÜLLER, H., "Die Stellung der Königsmutter Chentkaus beim Übergang von der 4. zur 5. Dynastie", **CdE** 45 (1970), 223-35.
- AUBERT, J-F., "Le mastaba de Sechemnéfer VI dit Héba", **Or** 44 (1975), 1-11.
- BADAWY, A., "La stèle funéraire sous l'ancien empire: son origine et son fonctionnement", **ASAE** 49 (1949), 213-43.
- , **The Tombs of Iteti, Sekhem'ankh-Ptah and Kaemnofert at Giza**, Berkeley 1976.
- , **The Tomb of Nyhetep-Ptah at Giza and the Tomb of 'Ankhm'ahor at Saqqara**, Berkeley 1978.
- BAER, K., **Rank and Title in the Old Kingdom: The Structure of the Egyptian Administration in the Fifth and Sixth Dynasties**, Chicago 1960.
- , "A Deed of Endowment in a Letter of the time of Ppjj I?", **ZAS** 93 (1966), 1-9.
- BARTA, W., **Die altägyptische Opferliste von der Frühzeit bis zur griechisch-römischen Epoche**, MAS 3, Berlin 1963.
- , **Aufbau und Bedeutung der altägyptischen Opferformel**, AF 24, Glückstadt 1968.
- von BISSING, F.W., **Die Mastaba des Gem-ni-k3i**, 2 bde., Berlin 1905-11.
- BLACKMAN, A.M., **The Rock Tombs of Meir**, 6 vols., 5 and 6 with M.R. Apted, ASE 22-5, 28-9, London 1914-53.
- van den BOORN, G.P.F., "On the date of the 'The Duties of the Vizier'", **Or** 51 (1982), 369-81.
- BORCHARDT, L., "Ein Königserlass aus Dahshur", **ZAS** 42 (1905), 1-11.
- , **Das Grabdenkmal des Königs Ne-user-re'**, WVDOG 7, Leipzig 1907.
- , **Das Grabdenkmal des Königs Nefer-ir-ke3-re'**, WVDOG 11, Leipzig 1909.

Bibliography

- , **Das Grabdenkmal des Königs S'a3hu-re'**, WVDOG 14, Leipzig 1910-13.
- , **Catalogue Général des Antiquités Egyptiennes du Musée du Caire: Statuen und Statuetten von Königen und Privatleuten**, 5 bde., Berlin 1911-36.
- , **Catalogue Général des Antiquités Egyptiennes du Musée du Caire: Denkmäler des Alten Reiches (ausser den Statuen)**, 2 bde., Cairo 1937-64.
- BRINKS, J., **Die Entwicklung der königlichen Grabanlagen des alten Reiches**, HAB 10, Hildesheim 1979.
- BRITISH MUSEUM, **Hieroglyphic Texts from Egyptian Stelae etc.**, London 1911 ff.
- BROVARSKI, E.J., "The Senedjemib Complex at Giza: An Interim Report", **L'égyptologie en 1979** II, 115-21.
- BRUNNER-TRAUT, E., **Die altägyptische Grabkammer Seschemnofers III aus Gfisa**, Mainz 1977.
- BUTZER, K.W., **Early Hydraulic Civilisation in Egypt: A Study in Cultural Ecology**, Chicago 1976.
- CAPART, J., **Une rue de tombeaux à Saqqarah**, 2 vols., Bruxelles 1907.
- de CENIVAL, J-L., "Les chefs de travaux dans l'ancienne Egypte (1)", *Ecole pratique des hautes études* IVe section, sciences, historiques et philologiques **Annuaire 1962/63**, 225-31.
- , "A propos de la stèle de Chéchi. Etude de quelques types de titulatures privées de l'ancien empire", **RdE** 27 (1975), 62-69.
- CURTO, S., **Gli scavi italiani a el-Ghiza (1903)**, Roma 1963.
- DARESSY, G., "La necropole des Grands Prêtres d'Héliopolis sous l'ancien Empire", **ASAE** 16 (1916), 193-212.
- DAUMAS, F., "L'origine d'Amon de Karnak", **BIFAO** 65 (1967), 201-14.
- DAVIES, N. de G., **The Mastaba of Ptahhetep and Akhethetep at Saqqara**, 2 vols., ASE 8-9, London 1900-01.
- , **The Rock Tombs of Deir el Gebrawi**, 2 vols., ASE 11-12, London 1902.
- , **The Tomb of Rekh-mi-re' at Thebes**, 2 vols., PMMA 11, New York 1943.
- DAVIES, W.V., el-KHOULI, A., LLOYD, A.B., and SPENCER, A.J., **Saqqara Tombs I. The Mastabas of Mereri and Wernu**, ASE 36, London 1984.
- DITTMAN, K.H., "Zum Titel ", **ZAS** 77 (1941), 7-12.
- DONADONI ROVERI, A.M., **I Sarcofagi egizi dalle origini alla fine dell'Antico Regno**, Roma 1969.
- DUELL, P., **The Mastaba of Mereruka**, 2 vols., OIP 31, 39, Chicago 1938.
- DUNHAM, D., "The Biographical Inscriptions of Nekhebu in Boston and Cairo", **JEA** 24 (1938), 1-8.
- DUNHAM, D. and SIMPSON, W.K., **The Mastaba of Queen Mersyankh III, Giza Mastabas I**, Boston 1974.
- EDEL, E., "Inschriften des Alten Reiches: II. Die Biographie des k3j-gmjnj (Kagemni)", **MIO** 1 (1953), 210-26.

Bibliography

- , "Inschriften des Alten Reiches: II. Die Biographie des Gaufürsten von Edfu, Jzj", **ZAS** 79 (1954), 11-17.
- , E., **Altägyptische Grammatik**, 2 bde., AnOr 34, 39, Roma 1955-64.
- ENDESFELDER, E., "Zur Frage der Bewässerung im pharaonischen Ägypten", **ZAS** 106 (1979), 37-51.
- EPRON, L., DAUMAS, F., GOYON, G., WILD, H., **Le Tombeau de Ti**, 3 vols.: I, Epron, Daumas, Goyon, MIFAO 65, Le Caire 1939; II, III, Wild, MIFAO 65, Le Caire 1953-66.
- FAKHRY, A., **Sept Tombeaux à l'est de la Grande Pyramide de Guizeh**, Le Caire 1935.
- el-FIKEY, Said Amer, **The Tomb of the Vizier Re'-wer at Saqqara**, *Egyptology Today* 4, Warminster 1980.
- FIRTH, C.M., and GUNN, B., **Teti Pyramid Cemeteries**, I text, II plates, Excav. Saqq., Le Caire 1926.
- FISCHER, H.G., "A Scribe of the Army in a Saqqara Mastaba of the Early Fifth Dynasty", **JNES** 18 (1959), 233-72.
- , "The Inspector of Youths Nfr-n-hwfw", **OMRO** 41 (1960), 1-13.
- , "A Provincial Statue of the Egyptian Sixth Dynasty", **AJA** 66 (1962), 65-9.
- , **Inscriptions from the Coptite Nome Dynasties VI-XI**, AnOr 40, Roma 1964.
- , "An Old Kingdom Monogram: ", **ZAS** 93 (1966), 56-69.
- , **Dendera in the Third Millennium B.C. down to the Theban Domination of Upper Egypt**, Locust Valley 1968.
- , "Offerings for an Old Kingdom Granary Official", **Bulletin of the Detroit Institute of Arts** 51 (1972), 69-80.
- , "Nbtj in Old-Kingdom Titles and Names", **JEA** 60 (1974), 94-99.
- , **Egyptian Studies I: Varia**, New York 1976.
- , "Five Inscriptions of the Old Kingdom", **ZAS** 105 (1978), 42-59, with Addenda in **ZAS** 107 (1980), 86-7.
- , "Two Old Kingdom Inscriptions Restored", **JEA** 65 (1979), 42-6.
- , Review of Hassan, **Excavations at Saqqara**, **JEA** 65 (1979), 176-82.
- FISHER, C.S., **The Minor Cemetery at Giza**, Philadelphia 1924.
- FREIER, E., "Zu den sogenannten Hohenpriestern des Ptah von Memphis im Alten Reich", **Altorientalische Forschungen** 4 (1976), 5-34.
- GARDINER, A.H., "An Administrative Letter of Protest", **JEA** 13 (1927), 75-8.
- , "Ramesside Texts relating to the Taxation and Transport of Corn", **JEA** 27 (1941), 19-73.
- GOEDICKE, H., "Diplomatical Studies in the Old Kingdom", **JARCE** 3 (1964), 31-41.
- , **Königliche Dokumente aus dem Alten Reich**, AA 14, Wiesbaden 1967.
- , **Die privaten Rechtinschriften aus dem Alten Reich**, Beihefte zur Wiener Zeitschrift für die Kunde des Morgenlandes 5, Wien 1970.
- GOYON, G., **Nouvelles Inscriptions rupestres du Wadi Hammamat**, Paris 1957.

Bibliography

- GRDSELOFF, B., "L'entrée du Mastaba de Sopdouhotep", *ASAE* 39 (1939), 389-92.
- , "Notice sur deux monuments inédits de l'Ancien Empire", *ASAE* 42 (1943), 107-25.
- , "Remarques concernant l'opposition à un rescrit du Vizir", *ASAE* 48 (1948), 505-12.
- GUNN, B., "A sixth dynasty Letter from Saqqara", *ASAE* 25 (1925), 242-55.
- HARPUR, Y.M., "Two Old Kingdom Tombs at Giza", *JEA* 67 (1981), 24-35.
- HASSAN, Selim, *Excavations at Giza*, 10 vols., Oxford/Cairo 1929-60.
- , *Excavations at Saqqara 1937-8*, 3 vols., Cairo 1975.
- HELCK, H.W., *Untersuchungen zu den Beamtentiteln des Ägyptischen alten Reiches*, *AF* 18, Glückstadt 1954.
- , "𓄏𓄏 = imj-r3", *ZAS* 79 (1954), 76-7.
- , "Bemerkungen zu den Pyramidenstädten im Alten Reich", *MDAIK* 15 (1957), 96-111.
- , *Zur Verwaltung des Mittleren und Neuen Reiches*, Probleme der Ägyptologie III, Leiden 1958.
- HODJASH, S. and BERLEV, O., *Egyptian Reliefs and Stelae in the Pushkin Museum of Fine Arts, Moscow*, Leningrad 1982.
- HOLSCHER, U., and MUNRO, P., "Der Unas-Friedhof in Saqqara. - 2. Vorbericht über die Arbeiten der Gruppe Hannover im Frühjahr 1974", *SAK* 3 (1975), 113-26.
- JAMES, T.G.H., *The Mastaba of Khentika called Ikhekhi*, (with M.R. Apted), *ASE* 30, London 1953.
- , Review of Baer, *Rank and Title in the Old Kingdom*, *JAOS* 83 (1963), 119-20.
- JEQUIER, G., *Tombeaux de Particuliers contemporaines de Pepi II*, Fouilles Saqq., Le Caire 1929.
- , "Rapport préliminaire sur les fouilles exécutées en 1933-1934 dans la partie méridionale de la nécropole memphite", *ASAE* 34 (1934), 76-82.
- , "Rapport préliminaire sur les travaux exécutées en 1934-1935 dans la partie méridionale de la nécropole memphite", *ASAE* 35 (1935), 31-4.
- , *Le Monument funéraire de Pepi II*, 3 vols., Fouilles Saqq., Le Caire 1936-40.
- JUNKER, H., *Grabungen auf dem Friedhof des Alten Reiches bei den Pyramiden von Giza*, 12 bde., *DAWW* 69-75, Wien 1929-55.
- , "Pḥrnr", *ZAS* 75 (1939), 63-84.
- , "Ein neuer Nachweis des Weisen Ddfḥr", *Fs Rosellini*, Studi II, 131-40.
- KANAWATI, N., *The Egyptian Administration in the Old Kingdom: Evidence on its Economic Decline*, Warminster 1977.
- , "The Identification of d'w/šm3i and d'w in the Decoration of their Tomb at Deir el-Gebrawi", *JEA* 63 (1977), 59-62.
- , *Governmental Reforms in Old Kingdom Egypt*, Warminster 1980.



Bibliography

- , **The Rock Tombs of el-Hawawish, the Cemetery of Akhmim**, Sydney 1980 ff.
- , "Deux conspirations contre Pepy Ier", *CdE* 56 (1981), 203-17.
- , **Excavations at Saqqara, North-west of Teti's Pyramid I**, Sydney 1984.
- KAPLONY, P., "Das Papyrusarchiv von Abusir", *Or* 41 (1972), 11-79, 180-248.
- , **Studien zum Grab des Methethi**, Bern 1976.
- , **Die Rollsiegel des Alten Reiches**, *Monumenta Aegyptiaca* 2-, Bruxelles 1977-.
- KAYSER, H., **Die Mastaba des Uhemka. Ein Grab in der Wüste**, Hannover 1964.
- KEES, H., "Beiträge zur altägyptischen Provinzialverwaltung und der Geschichte des Feudalismus": I, Oberägypten, *NAWG* 1932, 85-119, II, Unterägypten, *NAWG* 1933, 579-98.
- , "Beiträge zur Geschichte des Vezirats im Alten Reich", *NGWG N.F.* 4 nr. 2 (1940), 39-54.
- , "Ein Familie Kgl. Maurermeister aus dem Anfang der 6. Dynastie", *WZKM* 54 (1957), 91-100.
- , "Zur Datierung von Grabteilen des AR im British Museum", *OLZ* 57 (1962), 341-7.
- KLEBS, L., **Die Reliefs des alten Reiches (2980-2475 v. Chr.)**, *AHAW* 3, Heidelberg 1915.
- LEIBOVITCH, J., "Gods of Agriculture and Welfare in Ancient Egypt", *JNES* 12 (1953), 73-113.
- LEPSIUS, K.R., **Denkmaeler aus Aegypten und Aethiopien**, 12 bde. and Ergänzungsband, Berlin 1949-58, Leipzig 1913.
- , **Denkmaeler aus Aegypten und Aethiopien**, Texte. Herausgegeben von Eduard Naville, 5 bde., Leipzig 1897-1913.
- MACRAMALLAH, R., **Le Mastaba d'Idout**, Fouilles Saqq., Le Caire 1935.
- MALEK, J., "Istai, the Overseer of Hunters of the Desert", *GM* 18 (1975), 29-31.
- MARIETTE, A., **Les Mastabas de l'Ancien Empire**. Fragment du dernier ouvrage de A. Mariette, publié d'après le manuscrit de l'auteur par G. Maspero, Paris 1885.
- MARTIN, G.T., **The Tomb of Hetepka and other Reliefs and Inscriptions from the Sacred Animal Necropolis, North Saqqara 1964-73**, Texts from Excavations 4, London 1979.
- MARTIN-PARDEY, E., **Untersuchungen zur ägyptischen Provinzialverwaltung bis zum Ende des Alten Reiches**, *HAB* 1, Hildesheim 1976.
- MONTEY, P., **Scènes de la vie privée dans les Tombeaux Egyptiens de l'Ancien Empire**, Strasbourg 1925.
- MORET, A., **Catalogue général des Antiquités Egyptiennes du Musée du Caire: Denkmaeler des Alten Reiches III**, fasc. 1: Autels, Bassins et Tables d'offrandes, révisé et édité par Dia' Abou-Ghazi, Le Caire 1980.
- de MORGAN, J.J.M., "Découverte du Mastaba de Ptah-Chepses dans la Necropole d'Abou-sir", *RAr Ser.* 3 24 (1894), 18-33.
- , **Fouilles a Dahchour**, 2 vols., Wien 1895-1903.
- MOSTAFA, Maha M.F., **Untersuchungen zu Opfertafeln im Alten Reich**, *HAB* 17, Hildesheim 1982.

Bibliography

- MOUSSA, A.M., and ALTENMÜLLER, H., **The Tomb of Nefer and Ka-hay**, Old Kingdom Tombs at the Causeway of King Unas at Saqqara, Deutsches Archäologische Institut. Abteilung Kairo, Archäologische Veröffentlichungen 5, Mainz 1971.
- , **Das Grab des Nianchnum und Chnumhotep**, Old Kingdom Tombs at the Causeway of King Unas at Saqqara, Deutsches Archäologische Institut. Abteilung Kairo, Archäologische Veröffentlichungen 21, Mainz 1977.
- , "Bericht über die Grabungen des Ägyptischen Antikendienst im Osten der Ptahhotepgruppe in Saqqara im Jahre 1975", **MDAIK** 36 (1980), 319-47.
- MOUSSA, A.M. and JUNGE, F., **Two Tombs of Craftsmen**, Old Kingdom Tombs at the Causeway of King Unas at Saqqara, Deutsches Archäologische Institut. Abteilung Kairo, Archäologische Veröffentlichungen 9, Mainz 1975.
- MUELLER, D., "Some Remarks on Wage Rates in the Middle Kingdom", **JNES** 34 (1975), 249-63.
- MÜLLER, H.W., "Die Totendenksteine des Mittleren Reiches, ihre Genesis, ihre Darstellungen und ihre Komposition", **MDAIK** 4 (1933), 165-206.
- MUNRO, P., "Einige Bemerkungen zum Unas-Friedhof in Saqqara. 3. Vorbericht über die Arbeiten der Gruppe Hannover im Herbst 1978 und im Frühjahr 1980", **SAK** 10 (1983), 277-95.
- MURRAY, G.W., "A Note on the Sadd el-Kafara: the Ancient Dam in the Wadi Garawi", **BIE** 28 (1947), 33-46.
- MURRAY, M.A., **Saqqara Mastabas**, ERA 10-11, London 1905-1937.
- , **Index of Names and Titles of the Old Kingdom**, BSAE Studies I, London 1908.
- , "Some Fresh Inscriptions", **Ancient Egypt** 1917, 62-8.
- NEWBERRY, P.E., "The Inscribed Tombs of Ekhmim", **AAA** 4 (1912), 99-120.
- NIMS, C.F., "Some Notes on the family of Mereruka", **JAOS** 58 (1938), 638-47.
- PAGET, R.F.E., PIRIE, A.A. and GRIFFITH, F. L1., **The Tomb of Ptah-hotep**, BSAE 2, London 1898.
- PETRIE, H.F., and MURRAY, M.A., **Seven Memphite Tomb Chapels**, BSAE 65, London 1952.
- PETRIE, W.M.F., **Medum**, London 1892.
- PIRENNE, J., **Histoire des Institutions et du Droit Privé de l'Ancienne Egypte**, 3 vols., Bruxelles 1932-5.
- PORTER, B., and MOSS, R.L.B., **Topographical Bibliography of Ancient Egyptian Hieroglyphic Texts, Reliefs and Paintings**, 7 vols., Oxford 1927-52, second edition 1960 ff.
- POSENER-KRIEGER, P., **Les archives du Temple funéraire de Néferirkarê-Kakaï (Les papyrus d'Abousir)**, Traduction et Commentaire, 2 vols., BdE 65, Le Caire 1976.
- , "Les papyrus de Gebelein. Remarques préliminaires", **RdE** 27 (1975), 211-21.
- , "Fragments de papyrus provenant de Saqqarah", **RdE** 32 (1980), 83-93.
- POSENER-KRIEGER, P., and de CENIVAL, J.-L., Hieratic Papyri in the British Museum; Fifth Series, **The Abusir Papyri**, London 1968.

Bibliography

- QUIBELL, J.E., **Excavations at Saqqara, 1905-14**, 5 vols., Cairo 1907-23.
- REISNER, G.A., "A Family of Builders of the Sixth Dynasty, about 2600 B.C.", **BMFA** 11 (1913), 53-65.
- , **Mycerinus. The Temples of the Third Pyramid at Giza**, Cambridge 1931.
- , **A History of the Giza Necropolis**, 2 vols. (vol II with W.S. Smith), Cambridge 1942-55.
- REISNER, G.A., and FISHER, C.S., "Preliminary Report on the work of the Harvard-Boston Expedition in 1911-13", **ASAE** 13 (1913), 227-52.
- RUSCH, A., "Die Entwicklung der Grabsteinformen in Alten Reich", **ZAS** 58 (1923), 101-24.
- SAAD, Zaki, "A Preliminary Report on the Excavations at Saqqara 1939-1940", **ASAE** 40 (1940), 675-93.
- , "Preliminary Report on the Excavations of the Department of Antiquities at Saqqara 1942-1943", **ASAE** 43 (1943), 449-86.
- SALEH, Mohamed, **Three Old-Kingdom Tombs at Thebes**, Deutsches Archäologisches Institut. Abteilung Kairo, Archäologische Veröffentlichung 14, Mainz 1977.
- SCHMITZ, B., **Untersuchungen zum Titel s3-njswt "Königssohn"**, Habelts Dissertationsdrucke, Reihe Ägyptologie, Heft 2, Bonn 1976.
- SCHOTT, E., "Die Biographie des Ka-em-Tenenet", **Fs Otto**, 443-61.
- SCOTT, N.E., "Two Statue Groups of the V Dynasty", **BMMA NS** 11 (1952), 116-22.
- SETHE, K., "Geschichte des Amtes    im alten Reich", **ZAS** 28 (1890), 43-9.
- , **Urkunden des Alten Reiches**, Leipzig 1933.
- SIMPSON, W.K., **The Offering Chapel of Sekhem-ankh-ptah in the Museum of Fine Arts, Boston**, Boston 1976.
- , **The Mastabas of Qar and Idu, Giza Mastabas II**, Boston 1976.
- , **The Mastabas of Kawab, Khafkhufu I and II, Giza Mastabas III**, Boston 1978.
- , "Topographical Notes on Giza Mastabas", **Fs Edel**, 489-99.
- SMITH, W.S., "The Coffin of Prince Min-khaf", **JEA** 19 (1933), 150-9.
- , "The Old Kingdom Linen List", **ZAS** 71 (1935), 134-49.
- , "The Origin of Some Unidentified Old Kingdom Reliefs", **AJA** 46 (1942), 509-31.
- , **A History of Egyptian Sculpture and Painting in the Old Kingdom**, 2nd. ed., London 1949.
- , "Inscriptional Evidence for the History of the Fourth Dynasty", **JNES** 11 (1952), 113-28.
- , "The Judge Goes Fishing", **BMFA** 56 (1958), 56-63.
- SMITHER, P.C., "The Report Concerning the Slave-Girl Senbet", **JEA** 34 (1948), 31-4.
- SPENCER, A.J., "First and Second Owners of a Memphite Tomb Chapel", **JEA** 68 (1982), 20-6.
- STEINDORFF, G., **Das Grab des Ti**, Leipzig 1913.
- STRUDWICK, N.C., "The Overseer of Upper Egypt ny-k3w-izzi", **GM** 43 (1981), 69-71.

Bibliography

- , "Notes on the Mastaba of 3ht-htp; hmi and nb-k3w-hr; idw at Saqqara", **GM** 43 (1982), 89-94.
- , "Some Remarks on the Disposition of Texts in Old Kingdom Tombs with particular reference to the False Door", **GM** 77 (1984), 35-49.
- VANDIER, J., **Manuel d'Archeologie Egyptienne**, 6 vols., Paris 1952-78.
- VERNER, M., "Czechoslovak Excavations at Abusir", **Acts 1st ICE**, 671-5.
- WEIL, A., **Die Veziere des Pharaonenreiches**, Strassburg 1908.
- WIEBACH, S., **Die Ägyptische Scheintür: Morphologische Studien zur Entwicklung und Bedeutung der Hauptkultstelle in den Privat-Gräbern des alten Reiches**, Hamburger Ägyptologische Studien 1, Hamburg 1981.
- ZABA, Z., et al., **Preliminary Report on Czechoslovak Excavations in the Mastaba of Ptahshepses at Abusir**, Prague 1976.
- ZAYED, Abd el-Hamid, "Le tombeau d'Akhti-Hotep à Saqqarah", **ASAE** 55 (1958), 127-37.
- ZIEGLER, C., "La fausse-porte du prince Kanefer 'fils de Snefrou'", **RdE** 31 (1979), 120-34.

Index of Egyptian Names

* indicates beginning of entry in Prosopography

Entries not qualified by a number, place name or date do not all necessarily refer to the same individual.

- 3*hi* (1), 55*, 218, 223, 226, 253, 263, 277, 285, 287, 296
3*ht-mhw*, 195, 196
3*ht-htp* (2), 14, 16, 23, 55*, 87-8, 200, 252, 277, 301, 304-5, 308, 317
3*ht-htp*; *hmi* (3), 30, 33, 56*, 188, 192-3, 200, 252, 270, 277, 301, 308, 311
3*ht-htp* (4), 57*, 116, 177, 179, 182, 184, 185, 195
3*ht-htp*, 29, 165, 190, 196, 274, 294, 297-8
- iy* (5), 58*, 218, 222, 223
iy-mry, 139, 297
iy-nfrt; *š3nf* (6), 56-7, 58*, 104, 200, 277, 301, 309
iww (Abydos), 201, 279, 292, 302, 305-6, 319, 322
iwn-minw (7), 59*, 301, 308
iwn-r' (8), 59*, 219, 232-3, 238
ibi (Deir el Gebrawi), 173, 253, 279
ipi-hr-ssnbf (9), 60*, 253, 260, 262
iffi; *ffi* (10), 60*, 252, 253, 257, 263
imbi (11), 61*, 252, 257, 273
imn-m-ipt (Dynasty 18), 194
imn-m-h3t (Dynasty 13), 194
imn-df3s, 139
in-b3, 20
inpw-m-h3t, 195
- irw-k3-ptḥ* (12), 61*, 252, 257, 273
irw-k3-ptḥ (13), 62*, 200, 204
irw-k3-ptḥ, 13, 15
ihy (14), 62*, 177, 179
ihy (15), 56-7, 63*, 200, 218, 252, 277, 301, 308
ihy, 196
ihy (Thebes), 253
ihy (Dynasty 12), 93, 161
ihy-hnt (16), 63*, 302, 309, 322
izi (17), 65*, 277, 280, 281
izi (18), 66*, 278, 284, 285, 288, 289, 296, 298, 326
izi (Edfu), 173-4, 201, 215, 240, 302, 305, 319
izt3i, 119
išfi; *twtw* (19), 67*, 76, 252, 259, 260, 261, 278, 285, 287, 289, 325
išti; *tṭi*, 61
itif-h3i, 273
iti-sn, 196
itti (20), 67*, 219, 228, 229, 231
itti; *'nh-irs* (21), 68*, 219, 228, 229
idi (Abydos), 63-5, 91, 95-6, 201, 253, 302, 319, 322
idi (Koptos), 303, 319
idw I; *nfr* (22), 68*, 200, 219, 252, 278, 301, 309
idw (23), 69*, 177, 179, 185-6
idw II, 211
idwt; *zšzšt*, 63

- '3-3ht, 217
 'bwtw, 294
 'nhj; inti, 248, 285
 'nh-ir-ptḥ (24), 70*, 219, 229
 'nh-irs (25), 26, 71*, 218, 223
 'nh-izzi (26), 14, 71*, 218, 222, 223, 324
 'nh-wnis, 57
 'nh-wnis (Thebes), 253
 'nh-wsr-k3f (27), 72*, 184, 218, 222, 223, 227
 'nh-ppy hny-km (Meir), 254, 266, 278, 292, 303, 318, 319
 'nh-ppy hry-ib (Meir), 201, 254, 303, 311, 319
 'nh-m-'-r' (28), 73*, 252, 253, 257, 263, 265, 269, 273-4
 'nh-m-'-r' (29), 74*, 301, 308
 'nh-m-'-r', 16, 19, 149
 'nh-m-'-hr; zzi (30), 75*, 100-1, 167, 177, 184, 187, 188, 200, 218, 221, 277, 301, 309, 320
 'nh-m-'-k3i (31), 75*, 177, 179, 183, 184, 185, 219, 228, 229, 231
 'nh-m3', 27
 'nh-mry-r'; ny-sw-ihy (32), 76*, 219, 222, 223, 325
 'nh-mry-r' (33), 14, 77*, 153, 200, 219, 252, 278, 301, 309
 'nh-m-r', 273
 'nh-m-tnt, 196
 'nh-h3f (34), 42, 77*, 218, 301, 308, 327
 'nh-h3f; q3r (35), 51, 78*, 104, 277, 278, 279-80, 281, 285, 286, 291
 'nh-h3f, 297-8
 'nh-h'f-r', 68, 125
 'nh-hfw (36), 79*, 218, 223
 'nh-hfw, 51
- w3š-ptḥ; izi (37), 13, 26, 79*, 200, 202, 218, 301, 308, 311, 316, 327, 328
 wp-m-nfrt, 37, 184
 wni (Abydos), 189, 325, 330, 331
 wri, 298
 wr-irni (38), 80*, 277, 281, 283
 wr-ir-n-ptḥ, 27
 wr-b3w-b3 (39), 80*, 301, 308, 328
 wr-nww, 120
- wr-hww, 190, 191, 195
 wr-k3w-b3; ikw (40), 81*, 177, 187, 302, 309
 wr-k3-ptḥ (41), 81*, 252, 257
 wr-dd-ptḥ, 150, 196
 whmī, 216
 whmy, 295
 whmwnf (Dynasty 12), 213
 whm-k3i, 40
 wsr (Dynasty 18), 194
- b3wf-r', 168
 b3-b3f (42), 82*, 218, 301, 308, 311, 312, 313, 327, 338
 b3-špss, 195
 biw, 121
 bb-ib; sndm-ib (43), 83*, 220, 234
- ppi, 333
 ppy-mry-ptḥ-'nh, 170
 ppy-nḥt (Abydos), 201, 220, 238, 240, 303, 319
 ppy-ddi, 18
 prni-'nhw, 297
 pr-nb, 72, 114
 pr-sn (44), 48, 84*, 218, 223, 224
 pr-sn, 13, 25, 43, 105
 pr-[snt], 106
 ph-n-wi-k3i (45), 13, 19, 23, 84*, 184, 200, 218, 252, 277, 301, 308
 ph-r-nfr (46), 85*, 184, 218, 223, 226, 237, 253, 263, 277, 281, 283, 296, 297
 pth-m3-'hrw, 196
 pth-nb-nfrt, 274, 298
 pth-ḥtp dšr (47), 85*, 177, 200, 218, 301, 308
 pth-ḥtp (48), 86*, 177, 200, 218, 252, 255, 277, 301, 308
 pth-ḥtp (49), 13, 55, 87*, 88, 200, 218, 252, 277, 301, 308
 pth-ḥtp; tfi (50), 14, 16, 23, 88*, 87, 88*, 177, 178, 179, 184, 185, 301, 309, 320
 pth-ḥtp (51), 89*, 177, 200, 252, 278, 301, 309
 pth-ḥtp; iy-n-'nh, 195
 pth-ḥtp; iy-ni, 195
 pth-ḥtp, 195, 196, 300

Index of Egyptian Names

- pth-špss** (52), 89*, 218, 301, 308, 311, 316
pth-špss (53), 90*, 278, 285, 288, 325
pth-špss; impy (53a), 90*, 219, 223, 224
pth-špss; impy, 196
pth-špss, 13, 14, 19, 173, 196, 248
- ftk-t3**, 295
- m3-nfr** (54), 5, 91*, 148, 200, 204, 210
m3-nfr, 20, 105, 245
minw-nfr (55), 92*, 217, 218, 301, 308, 328, 329
minw-nfr, 92
mn-'nh-ppy; mni (56), 92*, 253, 260, 326
mn-htpw-k3k3i, 70
mn-k3, 191, 300, 335
mri; idw (57), 93*, 177, 178, 179, 186
mry (58), 13, 15, 61, 71, 83, 93*, 202, 216, 277, 281
mry-ib (59), 39, 43, 44, 45, 48, 94*, 218, 222, 223, 227
mry-ptḥ-mry-r' (60), 94*, 220, 234, 235, 244
mry-nzwt, 213, 273
mry-r'-i3m (61), 95*, 103, 121, 141, 302, 309, 315
mry-r'-mry-'nh-ptḥ; impy (62), 96*, 200, 219, 221, 233, 238, 302, 309
mry-r'-nfr; q3r (Edfu), 215, 318
mry-tti (63), 14, 97*, 177, 200, 219, 301, 309, 311
mrw; tti-snb (64), 97*, 253, 263
mrw-k3i (65), 98*, 199, 201, 204
mrrī (66), 98*, 278, 285, 325
mrrī (67), 14, 99*, 177, 200, 215, 219, 252, 278, 301, 309, 305
mrrī, 216
mrrw-k3i; mri (68), 14, 97, 100*, 177, 186, 195, 200, 218, 252, 278, 301, 309, 311, 316, 324-5
mrs-'nh III, 38, 74, 108, 162, 165
mrs-'nh, 85
- mrt-itīs**, 39, 139, 147, 165
mḥi, 269
mḥw (69), 14, 56, 77, 101*, 153, 177, 187, 200, 252, 278, 301, 309, 311
mḥw, 195
msdrw, 297
mtn, 13, 15, 66, 85
- ny-'nh-b3** (70), 56-7, 102*, 301, 309, 315
ny-'nh-ppy, 159-60
ny-'nh-ppy km; sbk-htp (Meir), 176, 253, 279
ny-'nh-r', 120-1
ny-'nh-r' (71), 102*, 218, 223, 224
ny-'nh-hnmw, 205, 269, 343
ny-'nh-snfrw, 195
ny-'nh-shmt, 13, 26, 85
ny-wsr-r', 74, 162
ny-m3't-inpw, 294
ny-m3't-sd 186, 196
ny-ḥb-sd-ppy (Abydos), 64
ny-ḥb-sd-nfr-k3-r' (72), 14, 64, 103*, 121, 200, 278, 302, 309
ny-ḥmt, 162
ny-s'nh-3ḥt; iti (73), 103*, 278, 284, 285, 297, 325
ny-sw-wsrt (74), 104*, 277, 280, 281
ny-sw-qd, 196, 297
ny-k3i-'nh (75), 104*, 218, 219, 221, 223, 227, 229, 231, 232
ny-k3w-izzi (76), 105*, 218, 223, 285, 324
ny-k3w-ptḥ (77), 106*, 277, 281, 283, 297
ny-k3w-r' (78), 50, 59, 106*, 301, 308
ny-k3w-r' (79), 107*, 219, 229, 231
ny-k3w-r', 270
ny-k3-nzwt, I 40, 43, 48
ny-k3-r' (80), 73, 107*, 252, 253, 259, 260, 263, 273, 328
nwb-htp, 27
nb-m-3ḥt (81), 74, 108*, 162, 301, 308
nb-k3w-ḥr; idw (82), 109*, 177, 252, 302, 309
nbt (Abydos), 63, 303
nbt, 56

Index of Egyptian Names

- nfw**, 297, 298
nfr (83), 109*, 277, 280, 281, 283
nfr (84), 38, 48, 49, 94, 109*, 109, 132, 277, 281, 285, 286
nfr, 13, 15, 43, 104, 205
nfri, 17, 213, 269
nfr-b3w-pth, 43, 47, 48
nfr-m3't (85), 49, 110*, 301, 308, 312
nfr-m3't (86), 110*, 218, 301, 308
nfr-hr-n-ptḥ, 273
nfr-sšm-ptḥ; šši; **wd3-ḥ3-tti** (87), 14, 22, 111*, 174, 177, 178, 179, 185
nfr-sšm-ptḥ, 13, 15
nfr-sšm-r'; šši (88), 14, 16, 76, 100-1, 112*, 177, 187, 200, 218, 252, 277, 301, 309, 325
nfr-sšm-sš3t; **ḥnw** (89), 112*, 148, 177, 200, 215, 219, 301, 309
nfrt, 212
nfrt-wnns, 65
nfrt-k3w, 110
nfrt-k3ws, 102
nn-ḥft-k3i, 19, 23, 27
nn-sdr-k3i, 27, 43
nn-gm, 215
nhri, 17, 127
nhbw; **mry-r'-mry-'nh-ptḥ** (90), 96, 113*, 170, 173, 219, 220, 221, 222, 223, 227, 234, 237, 241-3, 325
nhṯ-k3i, 273
nzwt-nfr, 40, 43, 48
nsr-k3w-hr, 339
ntr-wsr (91), 13, 19, 28, 114*, 177, 179, 183, 196, 200, 204, 206, 218, 222, 223, 226
ntr-nfr, 26, 27

r'-wr (92), 69, 114*, 219, 229
r'-wr (93), 14, 17, 115*, 301, 303, 309, 315, 325
r'-wr I, 211
r'-wr II, 195
r'-m-k3i, 316
r'-hr-k3i, 17
r'-ḥwf (94), 116*, 177, 179
r'-špss (95), 72, 90, 114, 116*, 151, 184, 196, 200, 204, 206, 214, 215, 218, 222, 223, 226, 252, 260, 261, 264, 301, 308, 318, 320, 328, 330
rh-mi-r' (Dynasty 18), 194, 332
rdi-n-ptḥ, 70

hnqw; **iy...f** (Deir el Gebrawi), 202, 303, 319

ḥwti, 26, 212
hp, 251
ḥm-iwnw (96), 42, 111, 117*, 218, 301 308, 312, 327
ḥm-r'; **izi** (Deir el Gebrawi), 303, 319
ḥmt-r', 14
ḥnwt, 56
ḥnwt-sn, 123, 147
ḥn-k3 (97), 118*, 218, 223, 227
ḥrwy I (Akhmim), 201, 302, 319
ḥrwy II (Akhmim), 302, 319, 322
ḥrwy (Akhmim), 212
ḥzzi (98), 118*, 218, 223, 226, 248, 252, 260, 261, 277, 285, 287, 324
ḥkni-hnmw (99), 119*, 177, 179, 182, 183
ḥtp (Dynasty 12), 161
ḥtpi, 274, 292, 296, 297
ḥtp-hr-3ḥt, 196
ḥtp-hr-n-ptḥ (100), 119*, 219, 232, 233
ḥtp-hrs II, 162, 165
ḥtp-hrs, 39, 78
ḥdt-ḥkrw, 136

ḥ'-inpw (101), 120*, 277, 281, 282, 283
ḥ'-b3w-ptḥ, 25
ḥ'-b3w-hnmw; **biw** (102), 121*, 164, 177, 199, 219, 236, 253, 278, 302, 309, 311, 326
ḥ'f-ptḥ, 106
ḥ'f-minw (103), 122*, 123, 147, 169, 218, 238, 301, 308, 321
ḥ'f-ḥwfw (104), 38, 42, 49, 122*, 147, 168, 174, 301, 308, 321
ḥ'f-ḥwfw (105), 123*, 135, 168, 219, 228, 229, 231, 232
ḥ'f-snfrw, 49, 110
ḥ'-mrr-ptḥ (106), 16, 124*, 177,

Index of Egyptian Names

- 179, 183, 200, 203, 204, 206,
218, 219, 221, 222, 223, 226,
233
- h'-mrr-nbty**, 89
- hwi**, 64
- hwi** (Abydos), 63, 303
- hwfw-htp** (107), 125*, 218, 223
- hnw** (108), 63, 65, 113, 125*,
302, 309, 326
- hnw**, 196
- hnty-k3i**; **ihhi** (109), 14, 101,
125*, 200, 219, 252, 278, 301,
309, 311, 325
- hnty-k3w-hr** (110), 126*, 177, 179
- htw**, 276
- hnmw**; **hnmw-nti** (111), 126*, 200,
204, 208, 268, 320, 343
- hnmw-htp** (112), 14, 127*, 252,
260, 261, 278, 285, 287, 326
- hnmw-htp**, 13, 15, 24, 205, 269,
274, 343
- hnmw-nti** (113), 50, 113, 128*,
177, 200, 218, 252, 277, 301,
309
- hnti** (Zawayda), 119
- hrdni**, 316
- zzi** (114), 14, 17, 128*, 301,
309, 325
- ztw** (115), 25, 129*, 200, 204,
205, 215
- ztw** (115a), 129*, 177, 179, 185
- ztw**, 333
- s3bw**; **ibbi** (116), 14, 19, 22,
112, 130*, 218, 223, 224, 226,
227, 248, 324
- s3bw-pth**; **ibbi** (117), 96-7, 130*,
219, 309
- s3bw**; **titi**, 91
- s3bni** (Aswan), 331
- s'nh-n-ptḥ** (118), 131*, 220, 234
- sbky**, 195
- sbk-m-ḥnt**, 61
- spdw-htp**, 26, 27, 124
- smnhw-ptḥ**; **itwš**, 285
- snfrw-snb**, 39
- snnw-k3i**; **kki** (119), 43, 48,
131*, 219, 229, 231
- sndm-ib**; **inti** (120), 50, 70,
132*, 128, 131, 140, 154, 177,
200, 214-15, 218, 235, 237,
240-1, 252, 277, 301, 308, 331
- sndm-ib**; **mhi** (121), 50, 113, 128,
133*, 200, 218, 237, 252, 285,
301, 308
- [s]ndm-ib**, 196
- sndm-[ib]**, 273-4
- shṭpw** (122), 134*, 150, 252, 257,
259, 260, 265
- shṃ-'nh-ptḥ** (123), 67, 134*, 200,
218, 301, 308
- shṃ-'nh-ptḥ** (124), 16, 135*, 149,
177, 179, 183, 200, 204, 206,
252, 260, 261
- shṃ-k3i**, 25, 92, 166-7, 196
- shṃ-k3-r'** (125), 59, 74, 136*,
301, 308, 327
- shntyw**, 13, 15
- sš3t-htp**; **hti** (126), 40, 42, 43,
48, 55, 136*, 174, 218, 222,
223, 237, 248, 301, 308, 311,
312, 313, 320, 327, 338
- sš3t-shntyw**, 37-8, 117
- sšmw** (127), 35, 137*, 218, 219,
221, 222, 223, 226, 227, 229,
231, 232, 252, 260, 261, 328
- sšmw** (128), 138*, 277, 281
- sšm-nfr** (129), 39, 40, 43, 46,
48, 138*, 139, 164, 184, 219,
229
- sšm-nfr** (130), 43, 48, 139*, 200,
204, 205, 206, 218, 222, 223,
226
- sšm-nfr** (131), 43, 48, 139*, 174,
200, 204, 205, 218, 301, 308,
320, 343
- sšm-nfr**; **hb3** (132), 20, 140*,
177, 179, 184, 185, 195
- sšm-nfr**, 274
- st-k3i**, 196
- sdf3w**, 297
- šy**, 268
- špsi**, 84-5
- šm3i** (Koptos), 202, 215, 303,
319, 330, 333
- šn'y** (133), 65, 121, 141*, 302,
309, 315
- šry**, 13, 15, 94
- šdy-ptḥ**; **šdw** (134), 141*, 278,
285, 288-9, 326

Index of Egyptian Names

- q3r; mry-r'-nfr** (135), 69-70,
 104, 142*, 219, 232, 233, 234
- k3i** (136), 5, 142*, 174, 176,
 177, 178, 179, 183, 184, 187,
 200, 204, 206, 210, 215, 218,
 222, 223, 226, 237, 277, 290,
 301, 308, 318, 320, 343
- k3i** (137), 144*, 218, 223, 226,
 277, 280, 285, 286, 287, 289,
 291, 328
- k3i-'pr** (138), 144*, 220, 234,
 235, 276
- k3i-'pr** (139), 26, 145*, 219,
 228, 229, 296, 297
- k3i-'pr**, 184, 196, 254
- k3i-'h3f** (139a), 146*, 219, 228,
 229, 231, 238
- k3i-w'b** (140), 49, 122, 123,
 146*, 162, 167, 301, 308, 321
- k3i-pw-inpw** (141), 148*, 200, 204
- k3i-pw-inpw** (142), 148*, 177,
 179, 181
- k3i-pw-nzw**; **k3i**, 41, 43, 48
- k3i-pw-nzw**, 248
- k3i-pw-r'** (143), 16, 19, 57,
 149*, 269-70, 277, 280, 281,
 283, 297, 298
- k3i-m-'nh**, 154, 296, 297-8
- k3i-m-nfrr**, 27, 196, 202, 212
- k3i-m-hzt**, 150-1
- k3i-m-snw** (144), 134, 149*, 252,
 257, 265, 273
- k3i-m-shm**, 49, 165
- k3i-m-qdi** (145), 27, 151*, 277,
 281, 283
- k3i-m-qdi**, 298
- k3i-m-tnt** (146), 71-2, 86, 151*,
 192, 218, 222, 223, 244, 330
- k3i-ny-nbf**, 119
- k3i-ny-nbfwi**; **hnw** (147), 152*,
 253, 260
- k3i-nfr** (148), 152*, 302, 309,
 311, 315
- k3i-nfr**, 37, 41, 43, 48, 55
- k3i-hp**, 25, 27, 88, 251
- k3i-hp**; **tti** (Akhmim), 254, 279
- k3i-hp**; **tti-iqr** (Akhmim), 254
- k3i-htp** (149), 153*, 302, 309,
 315
- k3i-hnt I** (Hemamiya), 220, 239
- k3i-hnt II** (Hemamiya), 220, 239
- k3i-hr-pt**; **ftk-t3** (150), 154*,
 252, 260, 325
- k3i-hr-pt**, 273
- k3i-swd3**, 41, 43
- k3i-s3mw**, 297
- k3i-gmni**; **mmi** (151), 14, 100-1,
 112, 154*, 173, 177, 192, 200,
 218, 252, 277, 301, 309, 311,
 316, 325
- k3i-tp** (152), 155*, 219, 229, 231
- k3i-dbh** (153), 156*, 277, 281,
 297
- k3h3i**, 13, 15, 205
- gfgf**, 212
- gmni-m-h3t**; **gmni** (154), 156*,
 253, 260
- tp-m-'nh** (155), 156*, 301, 309,
 320, 325
- tp-m-'nh**, 157
- tti** (156), 14, 121, 157*, 200,
 253, 265, 278, 302, 309, 311,
 326
- ty** (157), 27, 158*, 200, 204,
 205, 206, 218, 222, 223, 226,
 227, 267, 342-3
- tmrry** (Naga ed Deir), 220
- tnti** (158), 159*, 301, 309, 315,
 325
- tnti**, 26, 273, 297, 298
- tti** (159), 160*, 253, 260
- ttw** (160), 160*, 176, 177, 219,
 253, 265, 278, 302, 309, 311,
 314, 344
- dw3-n-r'** (161), 39-40, 43, 48,
 82, 162*, 301, 308, 311, 312,
 313, 327, 338
- dw3-n-hr**, 49, 165
- dw3-r'**, 74, 162
- dw3-r'** (162), 118, 163*, 219,
 228, 229, 231
- dbh**, 59, 103, 244
- dr-snd**, 274
- dgm**, 17
- ddw-sbk** (Dynasty 12), 193
- d3-mrw** (163), 163*, 253, 260, 326

Index of Egyptian Names

- d3ty (164), 164* 219, 229
d3ty (165), 49, 164*, 218, 222, 223, 238
d3ty (166), 166*, 219, 229
d'w (Deir el Gebrawi), 254, 279, 294
d'w; 3m3i (Deir el Gebrawi), 254, 279
d'w (Abydos), 63-4, 201, 214, 302, 319, 311
df3wi (167), 25, 35, 166*, 277, 280, 281, 283, 284, 285, 286, 288, 291, 328
dhwtj-nht (Dynasty 12), 193
ddf-minw, 49, 165
ddf-hr (168), 39, 49, 147, 167*, 218, 223, 224
ddf-hnmw (169), 168*, 219, 229
 Name Lost (170), 167, 168*, 218, 301, 308, 321, 327
 Name Lost (171), 169*, 277, 280
 Name Lost (172), 169*, 278, 280, 289, 292
 Name Lost (173), 170*, 173, 220, 234, 235, 242, 243
 Name Lost, 184, 243, 273
 Name Unknown, 196

Index of Titles

(not including those in the listings of the Prosopography)

- iwn knmwt, 178, 179, 187, 180, 184
im3-', 121, 310, 311, 312
imy-irty 'pr(wy) imw, 119
imy-irty k3t nbt nzwt, 217
imy-iz, 310, 311
imy-iz nhn, 310, 311
imy-r i'-r nzwt, 256, 259
imy-r izwt (nw) ' nzwt, 213
imy-r izwy (nw) pr md3t, 209
imy-r izwy (nw) pr hryw-wdb, 209
imy-r izwy (nw) hry htm md3t ' nzwt, 209
imy-r iz(wy) (n) hkr nzwt (nb), 281, 285-6, 290
imy-r ' nzwt, 318
imy-r ' nzwt 'h3w, 213
imy-r w'bt, 333
imy-r wpt (pyramid), 227, 288
imy-r wsh̄t, 179, 181, 187
imy-r wd3 n nwb m prwy pr-'3, 120
imy-r bh't (nbt) nt nzwt, 150, 256
imy-r pr, 212, 235
imy-r pr(wy)-'h3w, 284
imy-r pr-wr 6, 176
imy-r pr-hd n hmfw/snfrw/ddf-r', 278, 290, 292
imy-r pr-hd (n) hnw, 277, 280, 289, 298
imy-r prwy-nwb, 282, 284-5
imy-r prwy-hd n hnw, 278, 289
imy-r phw, 222, 223, 229, 233, 234
imy-r mš', 222, 223, 229, 233, 234, 243, 247
imy-r niwwt m3'wt (etc.), 262
imy-r niwt (pyramid), 185, 231, 308-9, 317, 318, 319
imy-r nw h3st, 119
imy-r hwt wrt 6 m3', 176
imy-r hwt 6 m iti-t3wy, 193
imy-r hmwt, 258
imy-r hmwt hkr nzwt, 258
imy-r hnty-š (pyramid), 227
imy-r ht wdt m k3t hft-hr, 248
imy-r zš 'prw n hwt wrt, 195
imy-r zš ' nzwt n wdt-mdw nbt nt nzwt, 201, 207
imy-r zš ' nzwt n k3t nbt nt nzwt, 201, 206
imy-r zš prwy-hd, 285, 297
imy-r zš md3t, 199
imy-r zš md3t n ' nzwt, 202, 203, 216
imy-r zš md3t nt šnw̄t, 260, 273
imy-r zš md3t šnw̄ty, 273
imy-r zš hwt wrt, 195
imy-r zš hryt-' nzwt, 230
imy-r zš (n) šnw̄t, 257, 273, 274
imy-r zš šnw̄ty, 273
imy-r zš (pyramid), 283
imy-r swt htpw df3w, 256, 259
imy-r swt df3w, 282
imy-r sh̄t htpw, 259
imy-r sšr, 290
imy-r sšr nzwt, 290
imy-r sty df3w, 282
imy-r šwy pr-'3, 289
imy-r šm'w, 64, 308-9, 317-18, 319, 334
imy-r šnw̄wt nzwt, 253, 263

- imy-r šnw(t), 254
 imy-r šnwty nt htpw ntr, 254
 imy-r šnwt nbt, 253, 263
 imy-r šnwt nbt nt nzwt, 253, 263
 imy-r šnwt nzwt, 253, 263
 imy-r šnwt nt hnw, 253, 259, 263, 265
 imy-r šnwt swt htpw df3w, 253, 263, 265, 269
 imy-r k3t m h'py '3, 248
 imy-r k3t m sp3wt hrywt-ib (šm'w), 220, 239
 imy-r gs imy-wrt '3 hr, 191
 imy-r gs(wy)-pr, 222, 223, 229, 233, 234
 imy-r (pyramid), 118, 207, 227, 231
 imy-r (sun temple), 207
 imy-ht pr-hd, 280, 281, 296, 297
 imy-ht prwy-hd, 285, 297
 imy-ht hm-ntr (pyramid), 227, 288
 imy-st-', 270
 iri 'nwt, 343
 iri šn, 343
 iry wd3 prwy-hd, 285, 297
 iry p't, 157, 223, 229, 233, 234, 260, 261, 285, 286, 307, 308-9, 310, 311, 318, 319, 339
 iry md3t ' nzwt, 213
 iry nhn, 196
 iry hnbtt n ' nzwt n pr-'3, 213
 iry-ht pr-hd, 281, 293-4, 297, 298

 '3 dw3w, 308-9, 316, 319
 'd-mr dw3-hr-hnty-pt, 312

 w'b nzwt, 230, 283
 w'b 200 (pyramid), 288
 w'b (king), 259
 w'b (pyramid), 231, 258-9, 262
 w' m wr(w) zh, 316
 wr bzt, 280, 281, 284, 285, 289
 wr md hwt 'nh, 197
 wr md hwt wrt, 195, 197
 wr md šm'w, 174, 178-9, 180-1, 184, 187, 197, 222, 223, 228, 229, 233, 234, 235
 wr hrp hmw, 224, 226
 wr 5, 316
 wr 5 pr dhwt, 117, 308-9, 316, 319

 wty inpw, 174
 wd' mdw m hwt wrt, 195
 wd'-mdw m hwt wrt 6, 195
 wd'-mdw št3 n hwt wrt, 195
 wd'-mdw n hwt wrt, 186, 195
 wd'-mdw (m3') n hryw-wdb, 186
 wd'-mdw n srw, 186

 mniw nhn, 197, 310, 311
 mty n z3 (pyramid), 262, 288
 mdw rhyt, 178, 179, 180, 184, 187, 282
 mdh zš nzwt, 184, 185, 199, 204, 215-16
 mdh qd nzwt (m prwy), 241-3
 mdh  , 215

 nht-hrw pr-hd, 297, 298
 nht-hrw n šnwt, 271-2, 273
 nht-hrw n šnwt nt hnw, 272, 273
 nst hntt, 178, 179, 180-1, 187, 257

 r p nb, 310, 311
 rh nzwt, 83, 183, 211, 223, 224, 229, 230, 233, 234, 235, 257, 258, 260, 261, 281, 282, 285, 286, 310, 311

 h3ty-', 157, 223, 229, 233, 234, 260, 261, 285, 286, 288, 308-9, 310, 311, 318, 319
 hm i3qs, 327
 hm-ntr wnw-r hnty minw, 316, 327
 hm-ntr wnw-r hnty-hm, see hm-ntr wnw-r hnty minw
 hm-ntr b3 'npt, 316
 hm-ntr b3stt, 316
 hm-ntr pth, 258
 hm-ntr m3't, 178, 179, 187, 207, 257
 hm-ntr r' m (sun temple), 185, 227, 231, 258-9, 262, 283
 hm-ntr r' hwthr m (sun temple), 227, 259
 hm-ntr rnnwtt, 283
 hm-ntr hr inpw hnty pr smswt, 327
 hm-ntr hr qm3-', 207
 hm-ntr hqt, 184-5, 207

- hm-ntr zkr, 258
 hm-ntr šsmtt, 316
 hm-ntr (pyramid), 185, 231, 259, 283, 298
 hm-ntr (king), 185, 227, 231, 258-9, 262, 283, 288
 hm-ntr (Horus name), 231, 262
 hry-wdb m hwt 'nh, 287, 312
 hry-sšt3 n wd'-mdw (nb) n/m hwt wrt, 195
 hry-sšt3 n wd'-mdw (nb) n/m hwt wrt 6, 195
 hry-sšt3 n wd'-mdw št3 (nb) n hwt wrt, 195
 hry-sšt3 n wdt-mdw (nbt) n nzwt, 174, 207
 hry-sšt3 n pr-dwšt, 287, 312
 hry-sšt3 n mdw št3 n hwt wrt, 195
 hry-sšt3 n mdw št3 n hwt wrt 6, 195
 hry-sšt3 n mdšt n hwt wrt, 195
 hry-sšt3 n nzwt m hwt wrt nt pr-nzwt, 190, 195
 hry-sšt3 n hwt wrt, 195, 197-8
 hry-sšt3 n sdmt w' m hwt wrt 6, 195
 hry-sšt3 (n) kšt nbt, 234, 248
 hry-sšt3 kšt nbt (nt) nzwt, 248
 hry-sšt3 kšt qd m ///, 248
 hry-sšt3 (pyramid), 283
 hry-tp mdw n wd'-mdw št3 n hwt wrt, 195
 hry-tp mdw št3 n hwt wrt, 195
 hry-tp nhb, 310, 311
 hqš bšt, 312
 hqš hwt, 213

 hšw, 272
 hm-', 327
 hnty-š (pyramid), 185, 231, 233
 hrp išt nbt nrt, 315
 hrp išts km, 312, 327
 hrp 'h, 228, 287, 312
 hrp wsht, 179, 180, 187
 hrp pr-hd, 228-9, 296, 297
 hrp mrt tš-mhw šm'w, 327
 hrp zš (nb), 204, 257
 hrp zš iry sprw, 184, 203, 204
 hrp zš wsht, 203, 204
 hrp zš pr hry-wdb, 204
 hrp zš n hwt wrt, 195
 hrp šndyt nbt, 316
 htm hšt dfšw bity, 282

 htm šnwt nzwt, 273
 htm dfšw bity, 282
 ht hš, 184-5, 207

 hry-hb, 226, 230, 262, 288, 315
 hry-hb hry-tp, 315
 hry sdšwty pr-hd, 297
 hry-tp nzwt, 150, 179, 182-3, 184, 185, 187, 204, 205, 211, 223, 224, 229, 230, 233, 234, 257, 258, 260, 261, 281, 282, 285, 286-7, 308-9, 310-11, 319, 320
 hry-tp nzwt m hwt wrt, 182
 hry-tp šnwt, 150, 256, 257, 260, 270, 271-2, 273, 274

 zšb n imy-wrt, 191
 zšb imy-r zš n kšt nbt, 234, 248
 zšb imy-r zš (pyramid), 185
 zšb iry nhn, 189
 zšb iry nhn mš', 189
 zšb iry nhn n hwt wrt, 189, 195
 zšb 'd-mr, 173, 178, 179, 180-1, 184, 185, 187, 191, 282, 286
 zšb nht-hrw, 282
 zšb šhd zš, 182
 zšb šhd zš n hwt wrt imy-wrt nt hnw, 190, 195
 zš nzwt (etc), 83, 108, 205, 223, 225, 229, 230, 233, 234, 307, 308-9, 312-13, 319
 zš ' nzwt (pr-'3), 204, 210-13
 [zš] ' nzwt šht, 212
 zš ' nzwt hft-hr (pr-'3), 210-13
 zš ' nzwt šnwt, 257, 273, 274
 zš wr md šm'w, 204
 zš pr-hd, 293-4, 296, 297, 298
 zš pr-hd wšd-swt-mry-kš-r', 292, 297
 zš mrt, 70
 zš nzwt, 257
 zš hryt-' nzwt, 204
 zš hryt-' šnwt, 257, 273
 zš n zš (pyramid), 185
 zš smsw n hwt wrt, 195
 zš šnwt, 271-2, 273
 zš šnwt hwt-'3t, 273
 zš šht htp-nzwt, 256
 zš sdšwty pr-hd, 293-4
 zš n tšty, 334

Index of Titles

- sm, 316, 335
 sm3' wd'-mdw n hwt wrt, 195
 smr, 83, 282, 287, 312
 smr w'ty, 182-3, 205, 223, 224-5,
 226, 229, 233, 234, 260, 261,
 285, 286-7, 288, 308-9, 310,
 318, 319
 smr w'ty n iti.f, 82-3
 smr w'ty n mrwt, 286
 smsw izt, 222, 223, 229, 233, 234
 smsw h3yt, 173
 smsw snwt, 310, 311
 shd iry-ht pr-hd, 281, 294, 297,
 298
 shd iry-ht n šnwt, 273
 shd iry-ht n šnwt nt hnw, 273
 shd 'prw ' nzwt, 213
 shd w'b r' m (sun temple), 227
 shd w'b (pyramid), 185, 227, 231,
 262
 shd pr-hd, 296, 297, 298
 shd nht-hrw n pr-hd, 297
 shd nht-hrw n hwt wrt, 195
 shd hm-ntr r' m (sun temple), 207
 shd hm-ntr (pyramid), 99, 185,
 288, 308-9, 317, 318, 319
 shd zš, 257
 shd zš ' nzwt, 211
 shd zš ' nzwt pr-hd, 296, 297
 shd zš ' nzwt šnwt, 273
 shd zš pr-hd, 280, 281, 285, 296,
 297, 298
 shd zš n hwt wrt, 195
 shd zs šnwt, 260, 271-2, 273
 sd3wty bity, 79, 260, 261, 308-9,
 310, 319
 sd3wty ntr (etc), 222, 223, 229,
 233, 234, 243
 sd3wty šnwt, 268
 sd3wty ... pr-hd, 281
 sdt nzwt, 327
 t3yty, 333
 t3yty sktt, 320, 343

Index of other Words and Phrases

- im³hw hr, 6, 123-4
imy-wrt, 191
iry sprw, 182
iz n pr ' nzwt, 209-10
iz n pr md³t, 209-10
iz n pr hryw-wdb, 209-10
iz n hry htm md³t, 209-10
iz(wy) n hkr nzwt, 286, 294
idmy, 40
- ' , 210
'prw, 222, 223, 229, 233, 234
'nzwt, 210-13
- wsht, 178
wd(t)-mdw, 179, 186, 204, 207,
223, 227-8, 228, 229, 233,
234, 260, 262, 289, 308-9,
317, 319
wd³t, 93
wd'-mdw (nb), 179, 181, 196
wd'-mdw št³, 196
- prwy-nwb, 280, 281, 285
pr-pr-hd, 294
- mrht, 294
mdd, 246
- n iti.f, 7
nfrw, 222, 223, 229, 233, 234
- rnpt zp, 3-4
rnnwtt, 283
- hbs m prwy-hd, 294
hmwt, 222, 223, 229, 233, 234
h³tp di nzwt, 269-70, 295
- h³ n t³ty, 194, 333
- hryw-', 213
hkr nzwt, 281, 285-6, 290
- z³ k³t, 245
- sšm, 246
- šnwt n nb, 267
šnwt nt hnw, 274
- qd, 222, 223, 229, 233, 234
- k³t, 222, 223, 229, 233, 234,
244-7
- tnt, 268-9
t³y, 305
tnwt, 269

MORE ABOUT KPI BOOKS

If you would like further information about books available from KPI please write to

The Marketing Department
KPI Limited
Routledge & Kegan Paul Plc
14 Leicester Square
London WC2H 7PH

In the USA write to

The Marketing Department
KPI Limited
Routledge & Kegan Paul
9 Park Street
Boston
Mass. 02108

In Australia write to

The Marketing Department
KPI Limited
Routledge & Kegan Paul
464 St. Kilda Road
Melbourne
Victoria 3004



KPI